20
07

DESIGN
YOUR
TIME

Index

COMPANY p. 04

PRODUCT RANGE SUM UP p. 24

26 PORCELAIN TILES

42 WALL TILES

52 PORCELAIN TILE DECORS

78 WALL TILE DECORS

2020 COLLECTIONS p. 92

TECHNICAL SPECIFICATIONS p. 546

550 GREEN PROJECT

551 V-SHADE, COLOUR-SHADING

552 SIZES RANGE

556 PORCELAIN TILES TECHNICAL SPECIFICATIONS

571 UPEC CERTIFICATION

572 DESTINATIONS OF USE

574 PORCELAIN TILES FOR OUTDOORS

576 ANTI-SLIP CLASSIFICATION

578 WALL TILES TECHNICAL SPECIFICATIONS

582 LAYING SUGGESTIONS

594 GENERAL PACKING AND WEIGHT

598 GENERAL SALES CONDITIONS

2020 Collections

428	3D Wall Design	Wall Tiles
232	Aix	Porcelain & Wall Tiles
300	Arbor	Porcelain & Wall Tiles
108	Arkshade	Porcelain & Wall Tiles
454	Arty	Wall Tiles
308	Axi	Porcelain Tiles
100	Blaze	Porcelain & Wall Tiles
120	Boost	Porcelain & Wall Tiles
242	Brave	Porcelain & Wall Tiles
438	Brick Atelier	Wall Tiles
94	Canone Inverso Piero Lissoni	Porcelain Tiles
250	Dolmen Pro	Porcelain Tiles
130	Dwell	Porcelain & Wall Tiles
258	Echo	Porcelain Tiles
316	Etic	Porcelain Tiles
322	Etic Pro	Porcelain Tiles
140	Evolve & Ewall	Porcelain & Wall Tiles
330	Exence	Porcelain Tiles
338	Heartwood	Porcelain Tiles
362	Granigliati	Porcelain Tiles
364	Greencolors	Porcelain Tiles
365	Groundtrack	Porcelain Tiles
260	Klif	Porcelain & Wall Tiles
268	Kone	Porcelain & Wall Tiles
148	Mark	Porcelain Tiles
174	Marvel	Porcelain & Wall Tiles
186	Marvel Dream	Porcelain & Wall Tiles
196	Marvel Edge	Porcelain & Wall Tiles
206	Marvel Gems	Porcelain Tiles
208	Marvel Pro	Porcelain & Wall Tiles
222	Marvel Stone Marble Look	Porcelain & Wall Tiles
280	Marvel Stone Stone Look	Porcelain & Wall Tiles
158	Mek	Porcelain & Wall Tiles
344	Nash	Porcelain Tiles
350	Nid	Porcelain & Wall Tiles
166	Raw	Porcelain & Wall Tiles
356	Room	Porcelain Tiles
288	Seastone	Porcelain Tiles
294	Trust	Porcelain Tiles

DECOR COLLECTION

94	CANONE INVERSO Piero Lissoni	Porcelain Tiles
----	--------------------------------	-----------------

METAL LOOK

100	BLAZE	Porcelain & Wall Tiles
-----	-------	------------------------

CONCRETE + RESIN LOOK

108	ARKSHADE	Porcelain & Wall Tiles
120	BOOST	Porcelain & Wall Tiles
130	DWELL	Porcelain & Wall Tiles
140	EVOLVE & EWALL	Porcelain & Wall Tiles
148	MARK	Porcelain Tiles
158	MEK	Porcelain & Wall Tiles
166	RAW	Porcelain & Wall Tiles

MARBLE LOOK

174	MARVEL	Porcelain & Wall Tiles
186	MARVEL DREAM	Porcelain & Wall Tiles
196	MARVEL EDGE	Porcelain & Wall Tiles
206	MARVEL GEMS	Porcelain Tiles
208	MARVEL PRO	Porcelain & Wall Tiles
222	MARVEL STONE	Porcelain & Wall Tiles

STONE LOOK

232	AIX	Porcelain & Wall Tiles
242	BRAVE	Porcelain & Wall Tiles
250	DOLMEN PRO	Porcelain Tiles
258	ECHO	Porcelain Tiles
260	KLIF	Porcelain & Wall Tiles
268	KONE	Porcelain & Wall Tiles
280	MARVEL STONE	Porcelain & Wall Tiles
288	SEASTONE	Porcelain Tiles
294	TRUST	Porcelain Tiles

WOOD LOOK

300	ARBOR	Porcelain & Wall Tiles
308	AXI	Porcelain Tiles
316	ETIC	Porcelain Tiles
322	ETIC PRO	Porcelain Tiles
330	EXENCE	Porcelain Tiles
338	HEARTWOOD	Porcelain Tiles
344	NASH	Porcelain Tiles
350	NID	Porcelain & Wall Tiles

FABRIC LOOK

356	ROOM	Porcelain Tiles
-----	------	-----------------

362	GRANIGLIATI	Porcelain Tiles
364	GREENCOLORS	Porcelain Tiles
365	GROUNDTRACK	Porcelain Tiles

LARGE SIZES

366	XL Range	Porcelain Tiles
-----	----------	-----------------

OUTDOOR DESIGN

408	Outdoor Range	Porcelain Tiles
-----	---------------	-----------------

WALL TILES

428	3D Wall Design	Wall Tiles
438	Brick Atelier	Wall Tiles
442	Aix	Wall Tiles
446	Arkshade	Wall Tiles
454	Arty	Wall Tiles
460	Blaze	Wall Tiles
466	Boost	Wall Tiles
470	Brave	Wall Tiles
474	Dwell	Wall Tiles
480	Ewall	Wall Tiles
486	Klif	Wall Tiles
490	Kone	Wall Tiles
494	Marvel	Wall Tiles
502	Marvel Dream	Wall Tiles
508	Marvel Edge	Wall Tiles
516	Marvel Pro	Wall Tiles
524	Marvel Stone	Wall Tiles
532	Mek	Wall Tiles
538	Raw	Wall Tiles

P O R C E L A I N A N D
W A L L T I L E S

A S A F E C H O I C E

Atlas Concorde

● IT DOES NOT BURN
Non brucia

● RECYCLABLE
Riciclabile

● HYGIENIC
Igienico

● VERSATILE
Versatile

● IT LOVES THE ENVIRONMENT
Ama l'ambiente

● LONG LASTING
Dura a lungo

● SAFE
Sicuro

● RESISTANT
Resistente

● ZERO PVC
Zero PVC

● ZERO VOCS
Zero VOC



FIORANO MODENESE
HQ, PORCELAIN TILE PLANT,
HOSPITALITY FACILITIES
Headquarter, stabilimento
produttivo di gres porcellanato,
facilities aziendali

450.000 m²
TOTAL PRODUCTION AREA
Totale area impianti
produttivi

FINALE EMILIA
WALL TILE PLANT
Stabilimento produttivo
rivestimenti

150.000 m²
AREA FOR FUTURE EXPANSION
Area per futura espansione

atlas concorde

P A S S I O N

P A S S I O N E

P A S S I O N

L E I D E N S C H A F T

P A S I Ó N

С Т Р А Ц Т Ь

Designing your time means living with a focus on the future. Researching the best technology, application innovation, beauty, and Italian style. At Atlas Concorde we produce ceramic surfaces that allow designers and customers from all over the world to best express their present.

Progettare il proprio tempo significa viverlo all'insegna del futuro. Ricerca della migliore tecnologia, dell'innovazione applicativa, della bellezza e dello stile italiano. In Atlas Concorde produciamo superfici ceramiche che consentano ai progettisti e ai clienti di tutto il mondo di declinare al meglio il proprio tempo presente.

Concevoir son propre temps signifie le vivre sous le signe du futur. Recherche de la meilleure technologie, d'applications innovantes, de la beauté et du style italien. Chez Atlas Concorde, nous fabriquons des revêtements céramiques qui permettent aux concepteurs et aux clients du monde entier de décliner au mieux le temps présent.

Die eigene Zeit sorgfältig zu planen bedeutet, sie zukunftsgerichtet zu leben. Auf der Suche nach der besten Technologie, nach innovativer Anwendung, nach Schönheit und italienischem Stil. Wir von Atlas Concorde produzieren Keramikbeläge, die Planern und Kunden in aller Welt die Möglichkeit geben, ihre eigene Gegenwart schön zu gestalten.

Diseñar el propio tiempo significa vivirlo en virtud del futuro. Investigación de las mejores tecnologías, de innovación en aplicaciones, de la belleza y el estilo italiano. En Atlas Concorde producimos superficies cerámicas que permiten a diseñadores y clientes de todo el mundo expresar mejor su propio tiempo presente.

Ценить и планировать свое время – значит жить с устремленностью в будущее. Для нас это означает разрабатывать лучшие технологии, внедрять инновации, нести в жизнь красоту и итальянский стиль. Мы, в Atlas Concorde, производим плитку, которая помогает дизайнерам и клиентам по всему миру найти в своем времени лучшее и извлечь из него максимум.

CERAMICHE CONCORDE FOUNDATION
Fondazione di Ceramiche Concorde

ATLAS CERAMICHE FOUNDATION
Fondazione di Atlas Ceramiche

CERAMICHE ATLAS CONCORDE FOUNDATION
Fondazione di Ceramiche Atlas Concorde

PORCELAIN TILE PRODUCTION STARTS
Inizia la produzione di gres porcellanato

ATLAS CONCORDE RUSSIA WAS BORN
Nasce Atlas Concorde Russia

ATLAS CONCORDE USA WAS BORN
Nasce Atlas Concorde Usa

ATLAS PLAN LAUNCH
Lancio del brand Atlas Plan

NEW LOGISTIC CENTER
Nuovo polo logistico

FACTORY 100% ENERGETIC AUTO SUFFICIENCY
Lo stabilimento produttivo raggiunge il 100% di autosufficienza energetica

1969

1974

1990

1998

2005

2016

2018

2020

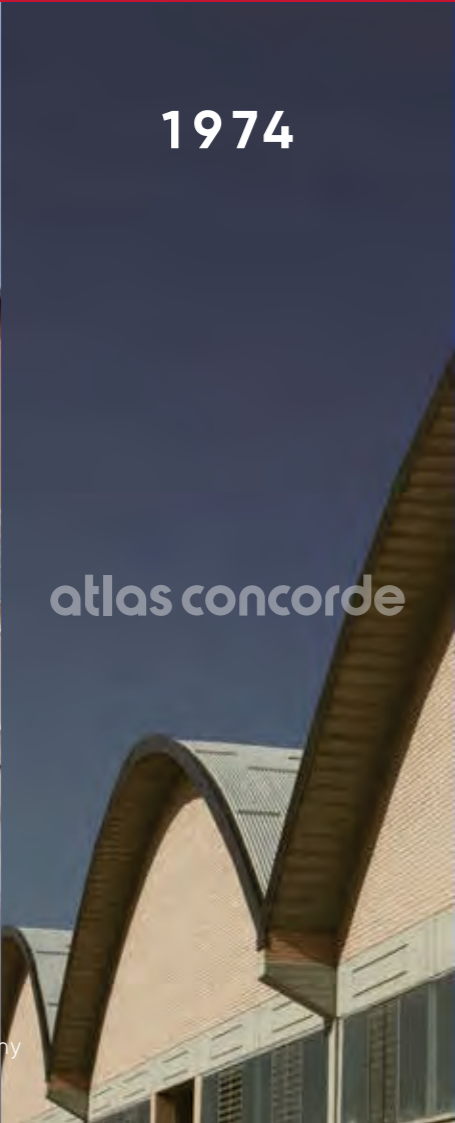

I N N O V A T I O N

I N N O V A Z I O N E

I N N O V A T I O N

I N N O V A T I O N

I N N O V A C I Ó N

И Н Н О В А Ц И И

Atlas Concorde employs the most advanced industrial technology, constantly updated with process and product innovations to develop ceramic surfaces of the highest quality. The recently inaugurated logistics hub is just the latest example of our focus on constant improvement.

Atlas Concorde possède une technologie industrielle de pointe, constamment mise à jour grâce à des innovations de processus et de produits, afin de développer des revêtements céramiques d'une qualité absolue. Le nouveau pôle logistique, inauguré tout récemment, n'est que le dernier exemple de la vocation à l'amélioration qui nous distingue.

Atlas Concorde verfügt über modernste Industrietechnologie und investiert stetig in Innovation von Verfahren und Produkten, um Keramikbeläge von absoluter Qualität zu garantieren. Das kürzlich eingeweihte, neue Logistikzentrum ist nur das jüngste Beispiel unseres Strebens nach ständiger Verbesserung.

Atlas Concorde dispone della tecnologia industriale più avanzata, costantemente aggiornata con innovazioni di processo e prodotto, per sviluppare superfici ceramiche di assoluta qualità. Il nuovo polo logistico recentemente inaugurato è solo l'ultimo esempio dell'attitudine al miglioramento che ci contraddistingue.

Atlas Concorde cuenta con la más avanzada tecnología industrial, constantemente actualizada con innovaciones de procesos y productos, para desarrollar superficies cerámicas de calidad absoluta. El nuevo centro logístico recientemente inaugurado es sólo el último ejemplo de la actitud de superación que nos distingue.

Atlas Concorde располагает самыми передовыми производственными технологиями, но при этом продолжает вести непрерывную инновационную деятельность, направленную на дальнейшее совершенствование как самого процесса производства, так и выпускаемых изделий, поскольку предлагаемая компанией плитка должна быть исключительно высокого качества. Новая логистическая платформа – лишь последний пример нашего безудержного стремления к совершенствованию.



atlas concorde

E X C E L L E N C E

E C C E L L E N Z A

E X C E L L E N C E

E X Z E L L E N Z

E X C E L E N C I A

К А Ч Е С Т В О

Excellence can only be achieved thanks to a strong passion that drives results that are always better. For us, this means creating products that combine the most advanced designs with the highest technical performance, thus offering designers and end users optimal solutions for all types of residential, commercial, and public applications, both indoors and out.

L'excellence s'obtient grâce à une grande passion qui pousse à atteindre les meilleurs résultats. Pour nous, cela signifie réaliser des produits en mesure d'allier le design le plus évolué aux plus hautes performances techniques, pour offrir ainsi aux concepteurs et aux utilisateurs finaux des solutions optimales pour chaque secteur d'application, soit résidentiel, commercial que public, tant d'intérieur que d'extérieur.

Exzellenz lässt sich nur mit echter Leidenschaft erreichen, die dazu anspornt, immer bessere Resultate anzustreben. Das bedeutet für uns, Produkte herzustellen, die das beste Design mit höchsten technischen Leistungen vereinen. Und optimale Lösungen für Planer und Endanwender zu finden, für jeden Bedarf in privaten wie öffentlichen Wohnungs- und Gewerbebauprojekten, für innen und außen.

La excelencia sólo puede lograrse gracias a una fuerte pasión que nos impulsa a conseguir mejores resultados. Para nosotros, esto significa realizar productos capaces de combinar el diseño más avanzado con las más altas prestaciones técnicas, ofreciendo así a los diseñadores y usuarios finales soluciones óptimas para todo tipo de aplicaciones residenciales, comerciales y públicas, tanto en interiores como en exteriores.

Чтобы добиться качества, необходима страсть. Глубокая страсть, которая вдохновляет на достижение все лучших результатов. Для нас это означает изготавливать плитку, которая сочетает в себе превосходный дизайн и самые высокие технические качества. Дизайнеры и потребители без труда найдут в нашем ассортименте оптимальное решение, где бы ни потребовалось уложить плитку – в домашних, коммерческих или общественных пространствах, внутри помещений или на улице.

D E S I G N

D I S E Ñ O

Д И З А Й Н

Atlas Concorde talent for design is demonstrated by its prestigious collections, which combine creativity, research, Italian style, and attention to detail in surfaces of excellence. Numerous formats, colors, finishes, decorations, application solutions, and special pieces fill a wide-ranging catalog, allowing professionals of international architecture maximum creative freedom.

La vocation au design d'Atlas Concorde est témoignée par des collections de grand prestige, qui savent traduire créativité, recherche, style italien et soin des détails en revêtements d'excellence. Notre vaste catalogue, très détaillé, présente de multiples formats, coloris, finitions, décors, solutions d'application et pièces spéciales, en offrant la plus grande liberté de création aux professionnels du bâtiment du monde entier.

Die Berufung von Atlas Concorde zum Design wird durch hochwertigste Kollektionen bezeugt, in denen sich Kreativität, Forschung, italienischer Stil und Liebe zum Detail verbinden. Daraus entstehen Keramikbeläge von absolutem Prestige. Die vielen Formate, Farben, Oberflächenausführungen, Dekore, Anwendungslösungen und Formteile bilden einen umfassenden und vielseitigen Katalog, der den Profis der internationalen Architektur maximale Gestaltungsfreiheit bietet.

La vocazione al design di Atlas Concorde è testimoniata da collezioni di assoluto prestigio, che fondono creatività, ricerca, stile italiano e cura del dettaglio in superfici di eccellenza. Numerosissimi formati, colori, finiture, decori, soluzioni applicative e pezzi speciali esprimono un catalogo ampio e articolato, che consente la massima libertà creativa per i professionisti dell'architettura internazionale.

La vocación al diseño de Atlas Concorde está atestiguado por colecciones de absoluto prestigio, que combinan creatividad, investigación, estilo italiano y atención a los detalles en superficies de excelencia. Numerosos formatos, colores, acabados, decoraciones, soluciones de aplicación y piezas especiales se expresan en un amplio y articulado catálogo, que permite la máxima libertad creativa a los profesionales de la arquitectura internacional.

Об умении Atlas Concorde находить незаурядные дизайнерские решения свидетельствуют ее престижные коллекции – сплав креативности, технологических разработок, итальянской стилистики, ухоженности деталей. Многочисленные форматы, цвета, фактуры поверхностей, декоры, специальные элементы образуют широкий ассортимент, дающий дизайнерам и архитекторам возможность реализовать любые замыслы в любой части света.

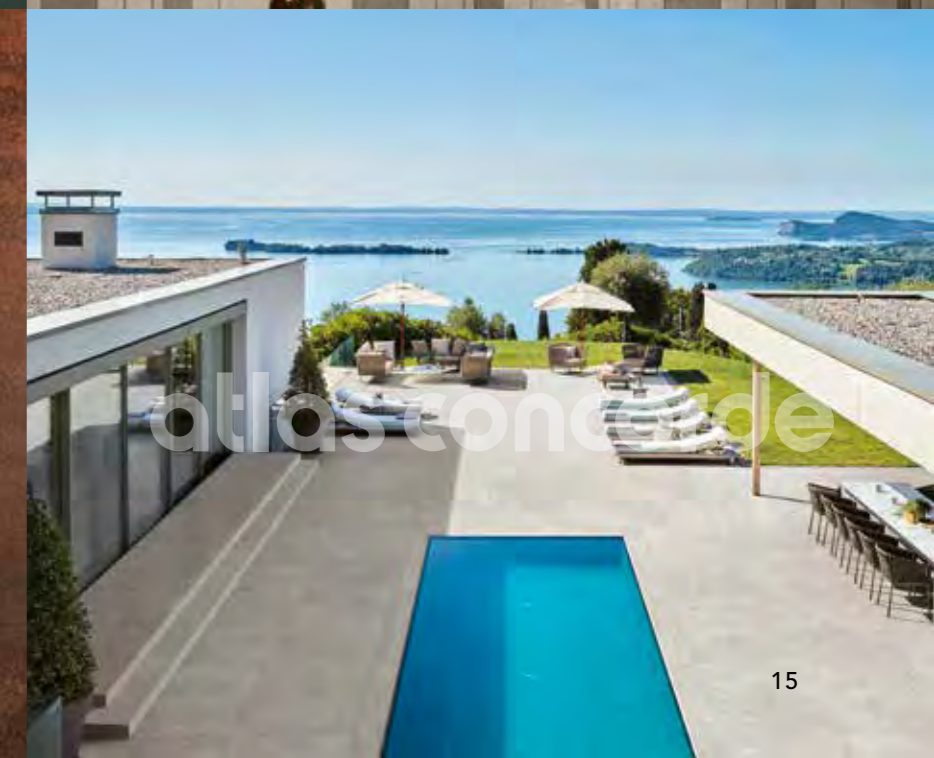

FIORANO MODENESE
 MAIN HEADQUARTER
 Sede principale
FINALE EMILIA, Italy
 ATLAS CONCORDE FACTORY
 Stabilimento produttivo Atlas Concorde

MOSCOW
 RUSSIA HEADQUARTER
 Sede centrale RUSSIA

FRANKLIN (TN)
 USA HEADQUARTER
 Sede centrale USA

atlas concorde

BRANCHES IN 120 COUNTRIES
 Sedi in 120 Paesi del mondo

COMMERCIAL OFFICES
 Uffici commerciali

DANIA BEACH, FLORIDA USA
 LONDON, UK
 LIONE, FRANCE
 PARIS, FRANCE
 SAINT PETERSBURG, RUSSIA

KIEV, UKRAINE
 STRIPE, LATVIA
 DUBAI, UAE
 BEIJING, CHINA
 SEOUL, SOUTH KOREA

WORLDWIDE

INTERNAZIONALITÀ

PRESENCE INTERNATIONALE

WELTWEIT

EN EL MUNDO

МИРОВОЙ МАСШТАБ

With production facilities in Italy, Russia, USA and branches in 120 countries, Atlas Concorde is an international company able to engage anywhere in the world with the efficiency that comes with being close to individual markets while offering the effectiveness of a global vision.

Con sedi produttive in Italia, Russia, Stati Uniti, oltre a sedi in 120 Paesi, Atlas Concorde si pone come un'azienda di livello internazionale, capace di agire ovunque nel mondo con l'efficienza della vicinanza ai singoli mercati e l'efficacia di una visione globale.

Avec des usines en Italie, en Russie et aux États-Unis, et des filiales dans 120 pays, Atlas Concorde se présente comme une entreprise projetée à l'échelon international, capable d'agir partout dans le monde avec l'efficiencia de la proximité sur chaque marché et l'efficacité d'une vision globale.

Mit Produktionsstätten in Italien, Russland und den Vereinigten Staaten und Filialen in 120 Ländern ist Atlas Concorde ein Player von internationalem Rang und in der Lage, überall in der Welt die einzelnen Märkte dank einer globalen Vision kundennah und effizient zu bedienen.

Con instalaciones de producción en Italia, Rusia y Estados Unidos, y con sedes en 120 países, Atlas Concorde es una empresa internacional, capaz de actuar en cualquier parte del mundo con la eficiencia de estar cerca de los mercados individuales y con la eficacia de una visión global.

Atlas Concorde располагает производственными площадками в Италии, России, Соединенных Штатах и представительствами в 120 странах мира. Эффективности такого мирового размаха способствуют в равной степени глобальное видение и глубокое знание специфики местных рынков.

H O S P I T A L I T Y

O S P I T A L I T À

S E R V I C E S D ' A C C U E I L

G A S T L I C H K E I T

H O S P I T A L I D A D

Г О С Т Е П Р И И М С Т В О

The Atlas Concorde headquarters in Fiorano Modenese is a prestigious structure, the crown jewel of a company that combines an international focus with local roots. Customers and designers from all over the world are welcomed in elegant, functional spaces enhanced by a showroom overlooking the beautiful park of Villa Casino Vicini, where guests can enjoy the restaurant and many other facilities.

Le siège d'Atlas Concorde de Fiorano Modenese est un établissement de prestige, véritable fleuron d'une entreprise qui, à la vocation internationale, allie son enracinement sur le territoire. Les clients et les concepteurs du monde entier sont accueillis au sein d'espaces élégants et fonctionnels, valorisés par un showroom qui donne sur le splendide parc de Villa Casino Vicini, où ils peuvent profiter du restaurant et de nombreux autres services.

Das Headquarter von Atlas Concorde in Fiorano Modenese ist ein beeindruckender Komplex und der ganze Stolz eines Unternehmens, das seine internationale Ausrichtung mit soliden lokalen Wurzeln verbindet. Kunden und Planer aus aller Welt werden in eleganten und funktionellen Räumlichkeiten willkommen geheißen. Dazu gehören auch der Showroom und der herrliche Park der Villa Casino Vicini mit dem Restaurant und vielen weiteren Annehmlichkeiten für die Gäste.

L'headquarter Atlas Concorde di Fiorano Modenese è una struttura di prestigio, fiore all'occhiello di un'azienda che unisce vocazione internazionale e radicamento sul territorio. I clienti e i progettisti di tutto il mondo sono accolti in spazi eleganti e funzionali, valorizzati da una showroom affacciata sullo splendido parco di Villa Casino Vicini, dove gli ospiti possono godere del ristorante e di tante altre facilities.

La sede central de Atlas Concorde en Fiorano Modenese es una estructura de prestigio, la joya de la corona de una empresa que combina la vocación internacional con sus raíces en el territorio. Clientes y diseñadores de todo el mundo son recibidos en espacios elegantes y funcionales, realizados por una sala de exposición con vistas al espléndido parque de Villa Casino Vicini, donde nuestros invitados pueden disfrutar del restaurante y de muchas otras instalaciones.

Штаб-квартира Atlas Concorde в Фьорано-Моденезе является предметом особой гордости для компании, сумевшей сплавить воедино местные промышленные традиции и международный размах деятельности. Здесь клиентов и дизайнеров со всего мира ожидают функционально обустроенные пространства для работы и отдыха, современный шоу-рум с видом на роскошный парк виллы Казино Вичини, уютный ресторан и много других удобств.





P R O J E C T S

P R O G E T T I

P R O J E T S

P R O J E K T E

P R O Y E C T O S

П Р О Е К Т Ы

The best evidence of the popularity of Atlas Concorde ceramic surfaces are the numerous projects that demonstrate how architects and interior designers use our products for international projects.

La conferma migliore dell'apprezzamento delle superfici ceramiche Atlas Concorde sono le numerosissime realizzazioni che ovunque nel mondo testimoniano come progettisti e interior designer utilizzino i nostri prodotti per progetti di respiro internazionale.

La meilleure confirmation de l'appréciation des revêtements céramiques d'Atlas Concorde réside dans les innombrables réalisations qui témoignent partout dans le monde que les concepteurs et les designers d'intérieur utilisent nos produits pour des projets d'envergure internationale.

Die beste Bestätigung für den Erfolg der Keramikbeläge von Atlas Concorde sind die unzähligen Beispiele für die kreativen Projekte, die Planer und Innendesigner in aller Welt mit unseren Produkten gestaltet haben.

La mejor confirmación de la apreciación de las superficies cerámicas Atlas Concorde son las tan numerosas creaciones en todo el mundo que muestran cómo arquitectos y diseñadores utilizan nuestros productos en proyectos internacionales.

Лучшим подтверждением того, насколько высоко ценится плитка Atlas Concorde, служат многочисленные проекты, реализованные с ее использованием проектировщиками и дизайнерами в самых разных частях света.

R E S P O N S I B I L I T Y

R E S P O N S A B I L I T À

R E S P O N S A B I L I T E

V E R A N T W O R T U N G

R E S P O N S A B I L I D A D

O T B E T C T B E H H O C T Ь

Respect for the environment and social responsibility are core values for Atlas Concorde. Our industrial processes comply with the primary international regulations and we have a low-impact energy cogeneration plant that makes us 100% autonomous. Atlas Concorde also offers its employees company welfare programs like Asilo Concorde nursery school for children of employees and from the local community.

Le respect de l'environnement et la responsabilité sociale sont des valeurs qu'Atlas Concorde poursuit constamment. Nos processus industriels sont conformes aux principales réglementations internationales et nous disposons d'une installation de cogénération d'énergie à faible impact qui nous rend indépendants à 100%. Atlas Concorde est également active dans des programmes de bien-être d'entreprise pour ses collaborateurs, comme Asilo Concorde (crèche Concorde), réservé aux enfants des employés mais qui est aussi ouvert à la communauté locale.

Verantwortung für Umwelt und Gesellschaft sind von Atlas Concorde konstant verfolgte Werte. Unsere Industrieprozesse entsprechen den wichtigsten internationalen Richtlinien, und wir verfügen über eine umweltschonende Kraft-Wärme-Kopplungsanlage, die uns zu 100 % energieautonom macht. Atlas Concorde bietet seinen Mitarbeitern zudem betriebliche Welfare-Programme wie die Kinderkrippe Asilo Concorde für die Kinder der Beschäftigten, die auch Kinder aus der Umgebung aufnimmt.

El respeto por el medio ambiente y la responsabilidad social son valores que Atlas Concorde persigue en forma constante. Nuestros procesos industriales cumplen con las principales normativas internacionales y disponemos de una planta de cogeneración de energía de bajo impacto que nos vuelve autónomos al 100%. Atlas Concorde también participa activamente en los programas de bienestar empresarial para sus empleados, como la guardería infantil Asilo Concorde, reservada a los hijos de los empleados y abierta también a la comunidad local.

Бережное отношение к окружающей среде и социальная ответственность стоят в ряду основных ценностей Atlas Concorde. Наши производственные технологии отвечают требованиям основных международных стандартов, а кроме того, на заводе работает собственная когенерационная установка, которая при минимальном воздействии на окружающую среду позволяет нам быть энергетически независимыми. Atlas Concorde заботится и о благополучии своих сотрудников. С этой целью был открыт детсад Concorde, который, наряду с детьми работников самой компании, посещают также дети многих других родителей города.

Il rispetto dell'ambiente e la responsabilità sociale sono valori che Atlas Concorde persegue con costanza. I nostri processi industriali sono conformi alle principali normative internazionali e disponiamo di un impianto di cogenerazione energetica a basso impatto che ci rende al 100% autonomi. Atlas Concorde è attiva inoltre con programmi di welfare aziendale per i collaboratori, come l'Asilo Concorde, riservato ai figli dei dipendenti e aperto anche alla Comunità locale.





Product range sum up

- 26 PORCELAIN TILES
- 42 WALL TILES
- 52 PORCELAIN TILE DECORS
- 78 WALL TILE DECORS

Porcelain tiles | Marble Look

Gres porcellanato

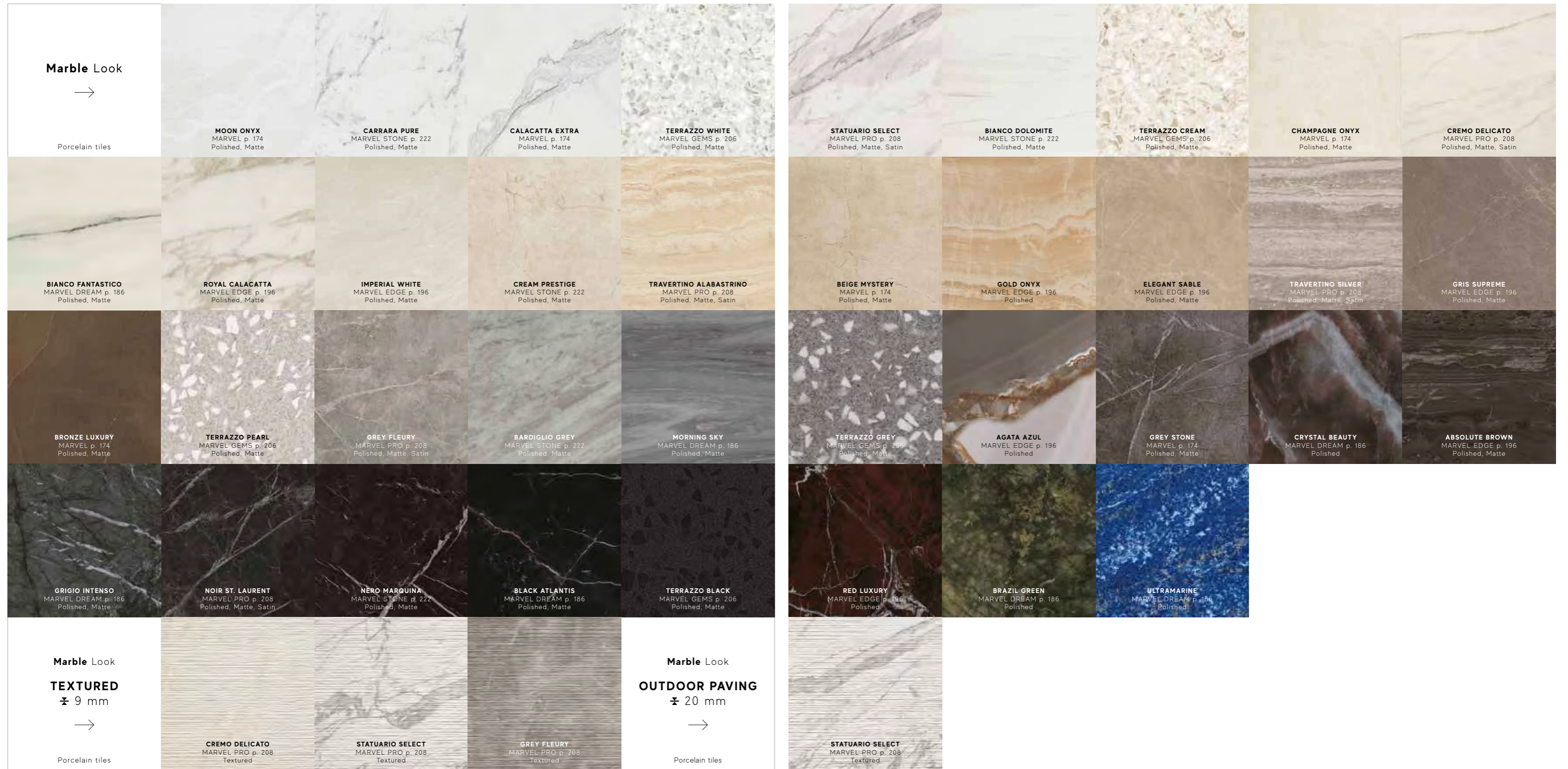

Porcelain tiles | Concrete + Resin Look

Gres porcellanato

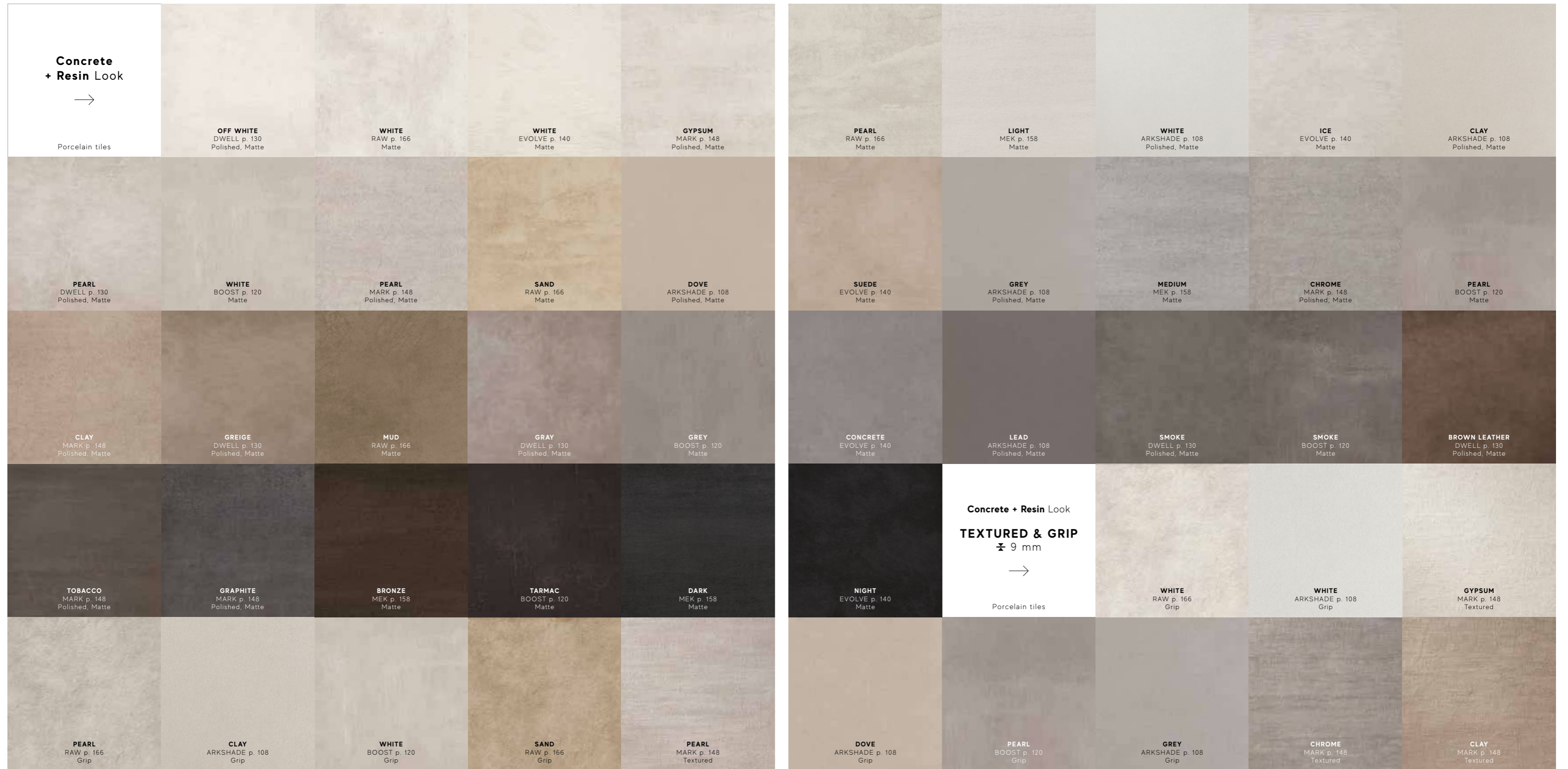

Porcelain tiles | Concrete + Resin Look

Gres porcellanato



Porcelain tiles | Metal Look

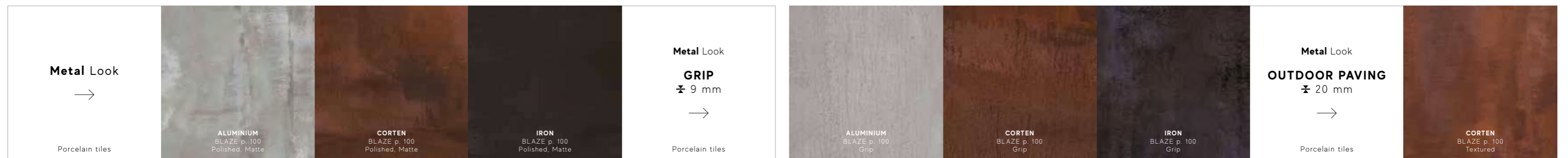

Porcelain tiles | Stone Look

Gres porcellanato



Porcelain tiles | Stone Look

Gres porcellanato

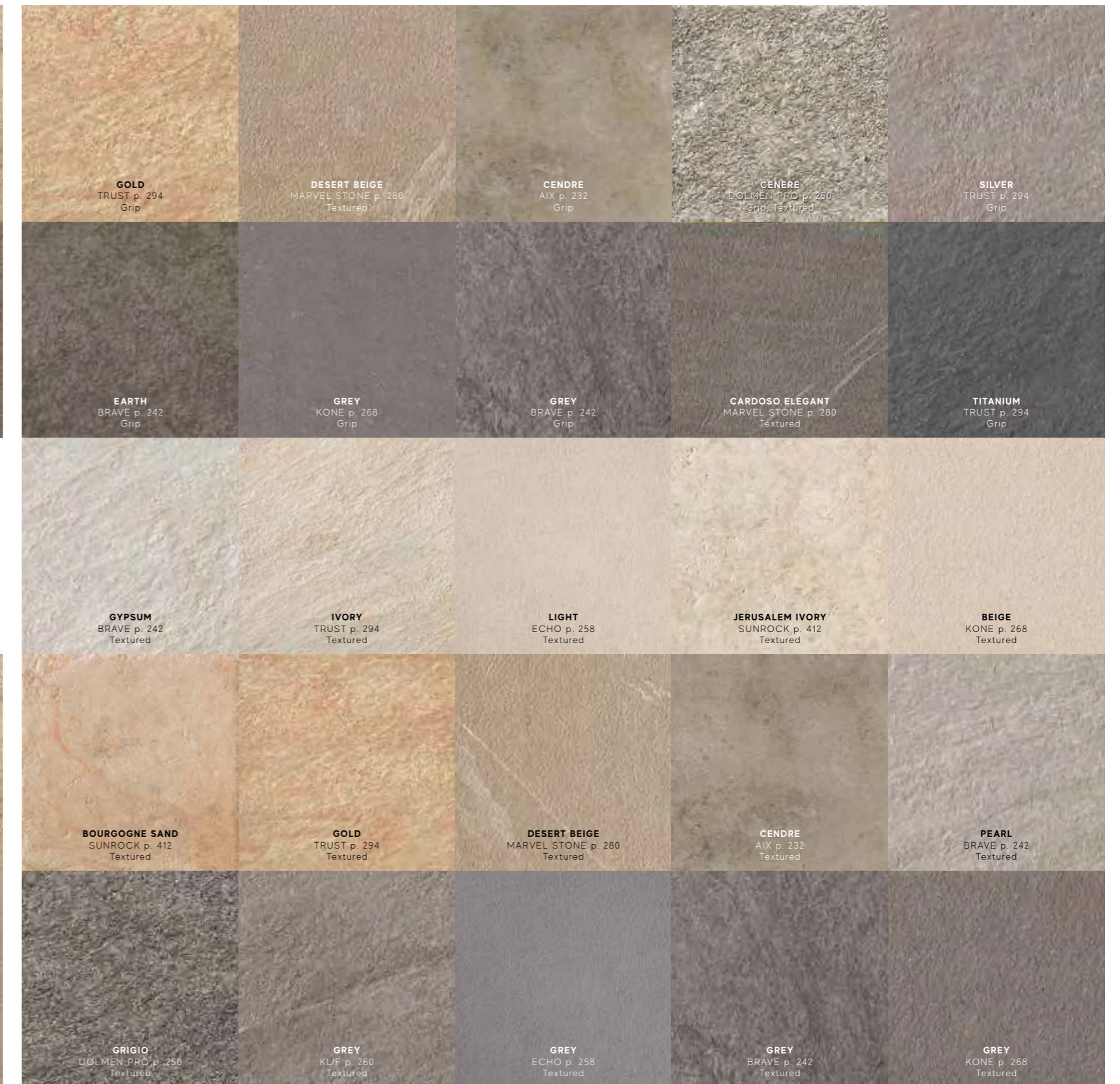
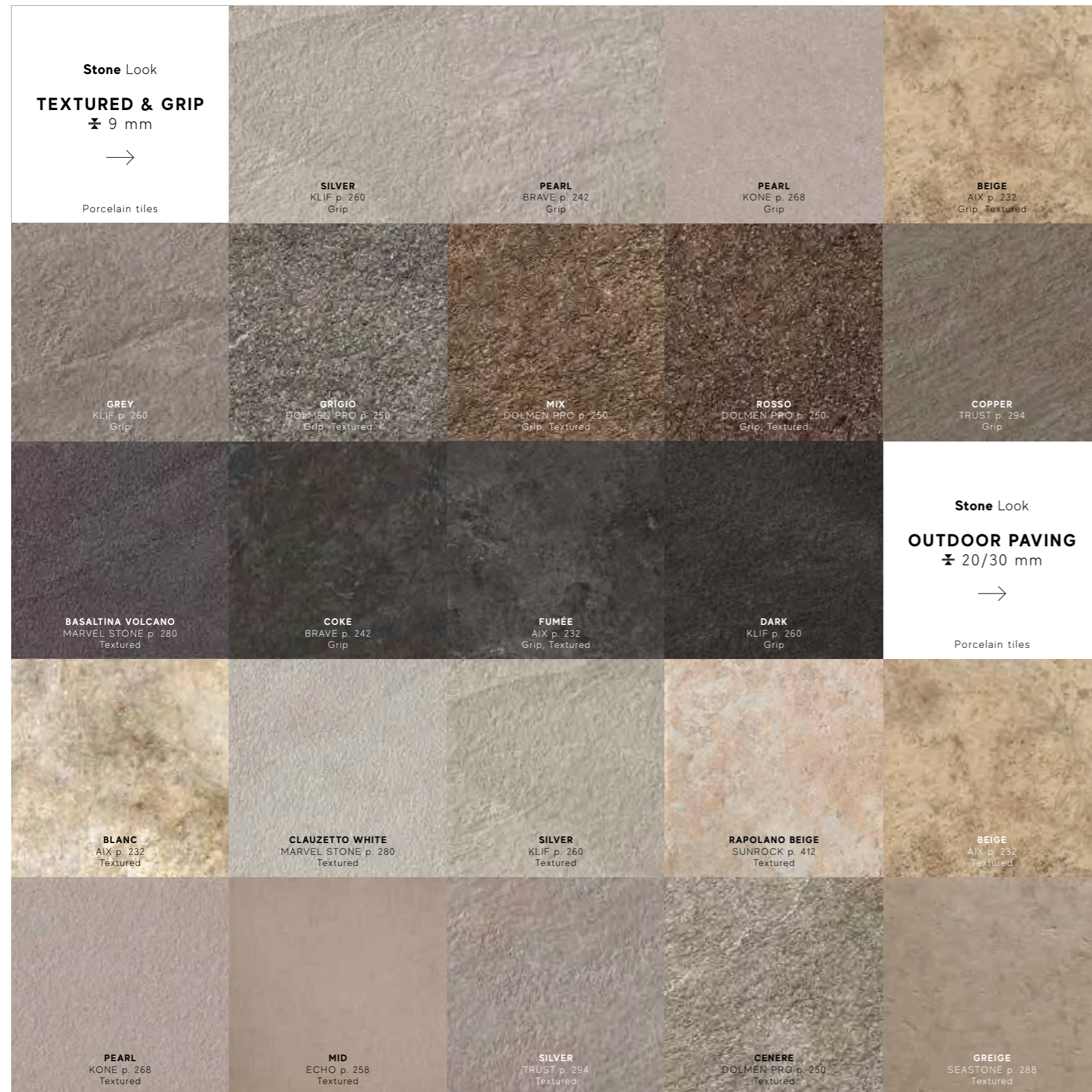

Porcelain tiles | Stone Look

Gres porcellanato

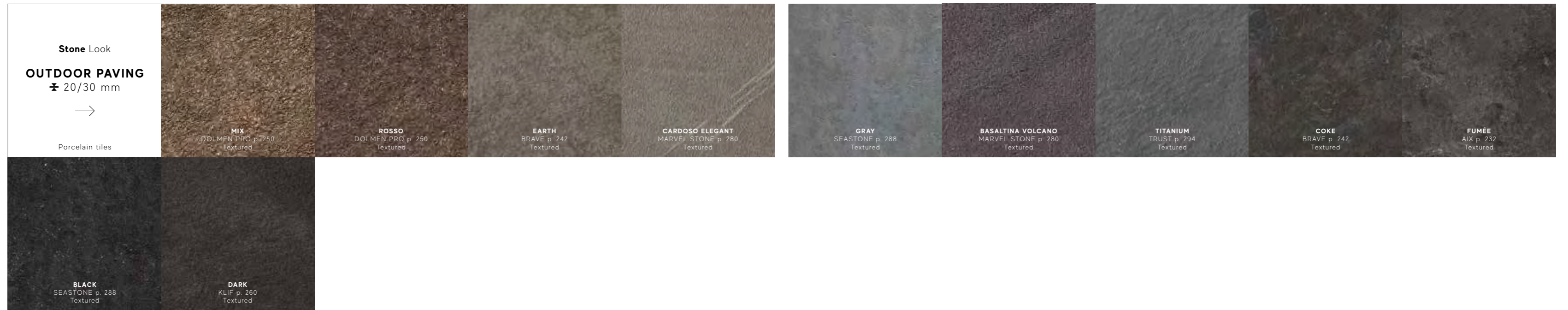

Porcelain tiles | Fabric Look

Gres porcellanato



Porcelain tiles | Wood Look

Gres porcellanato

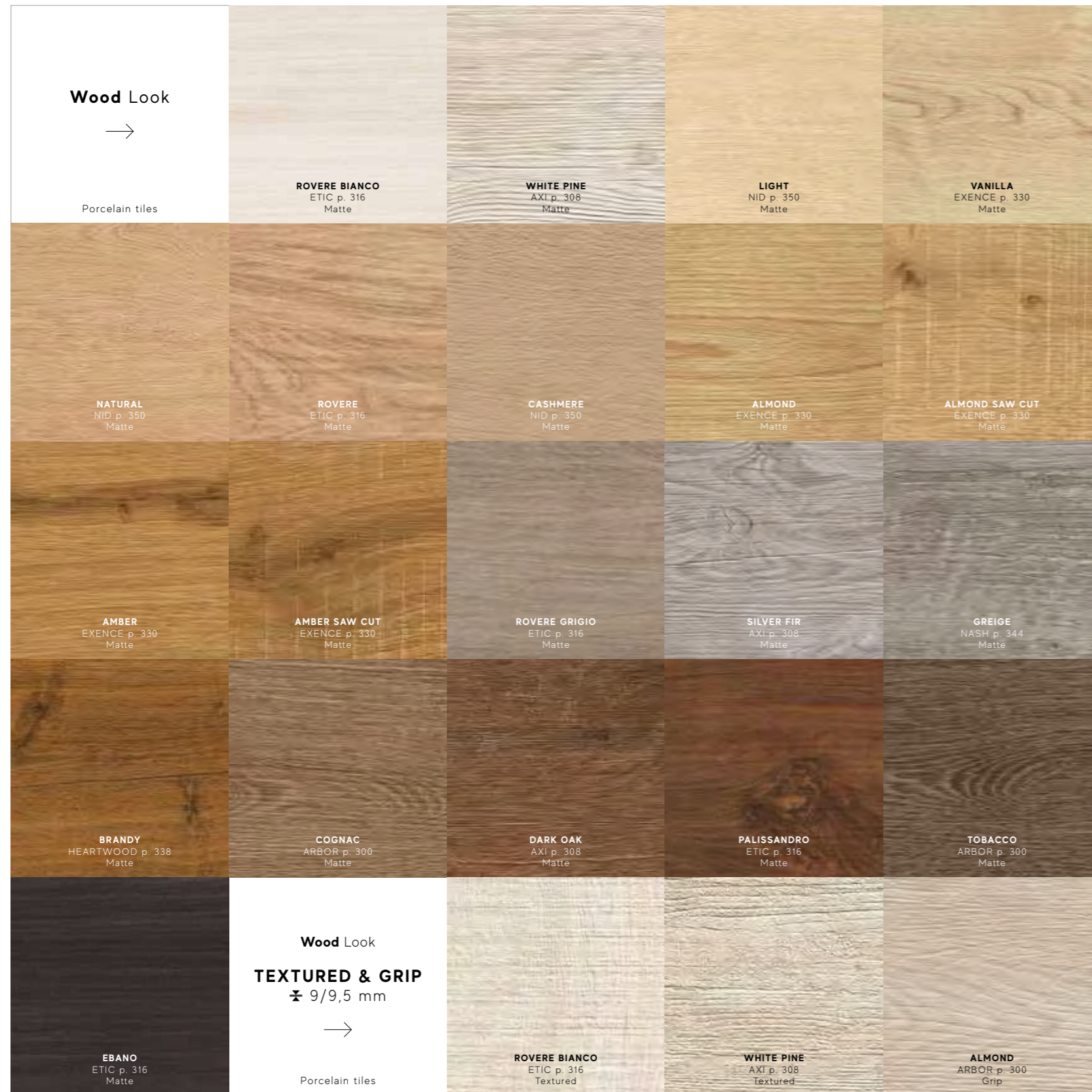

Porcelain tiles | Wood Look

Gres porcellanato



Wall tiles | Marble Look

Rivestimenti

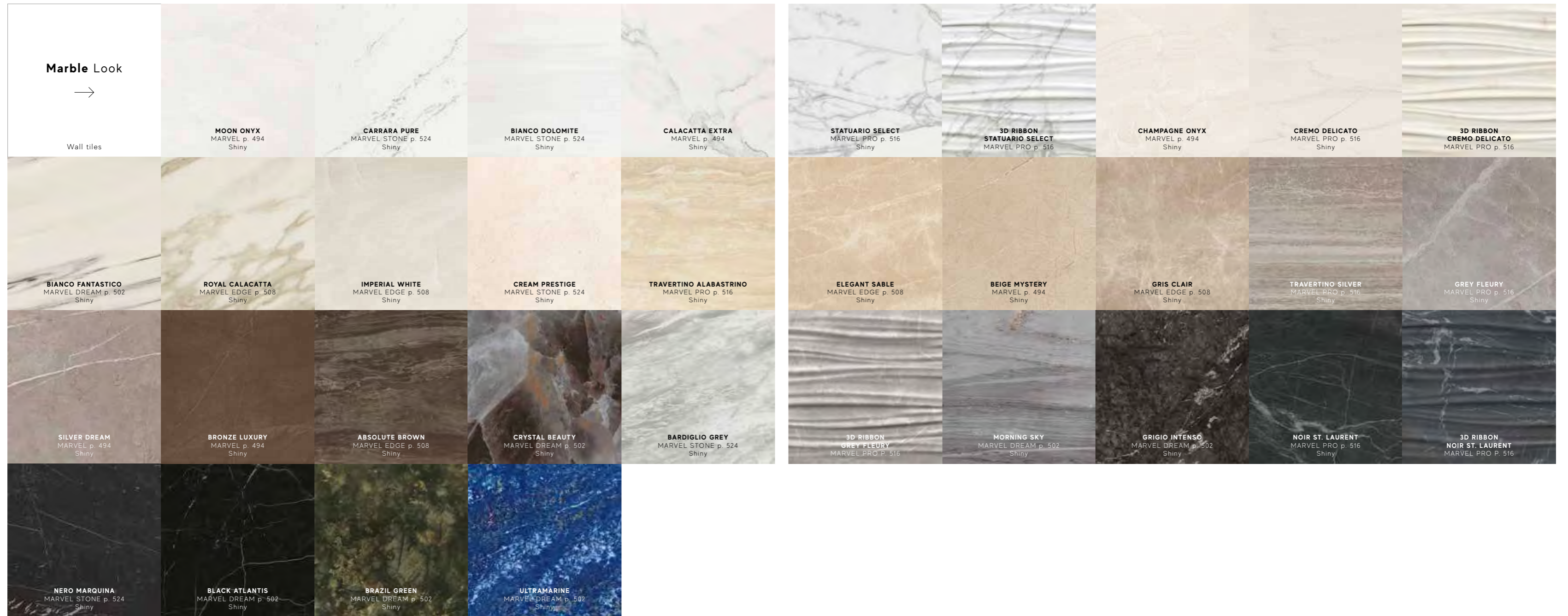

Wall tiles | Concrete + Resin + Metal Look

Rivestimenti



Wall tiles | Color Look

Rivestimenti



Wall tiles | Stone Look & Wood Look

Rivestimenti

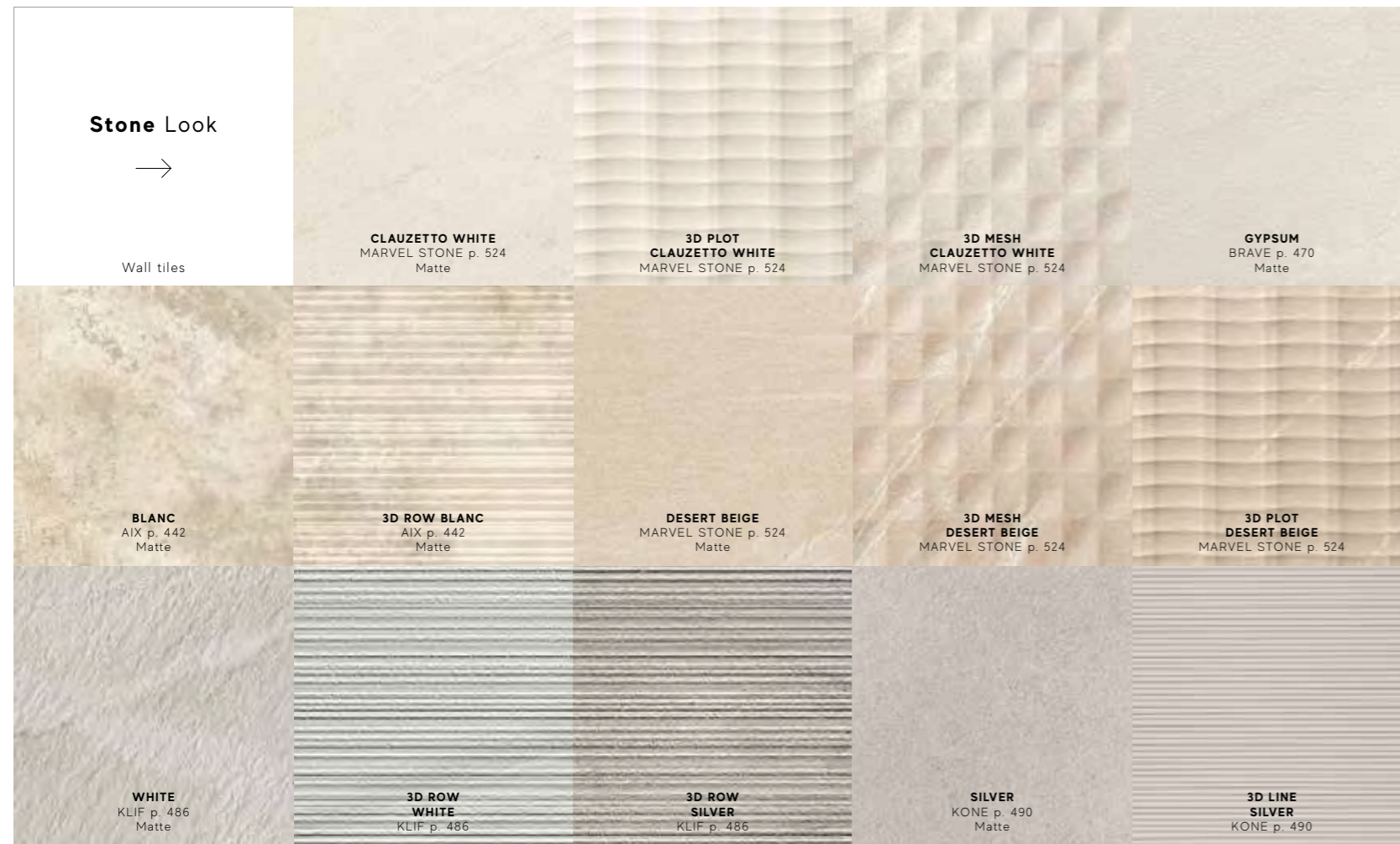

Wall tiles | Wood Look

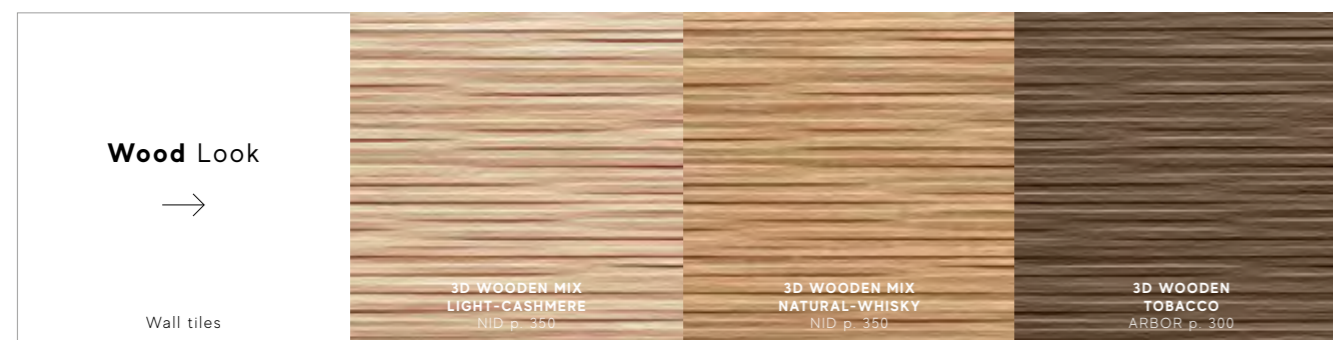

Wall tiles | 3D Wall Design

Rivestimenti p. 428



Porcelain tile decors | Marble Look

Decori in gres porcellanato



Porcelain tile decors | Marble Look

Decori in gres porcellanato

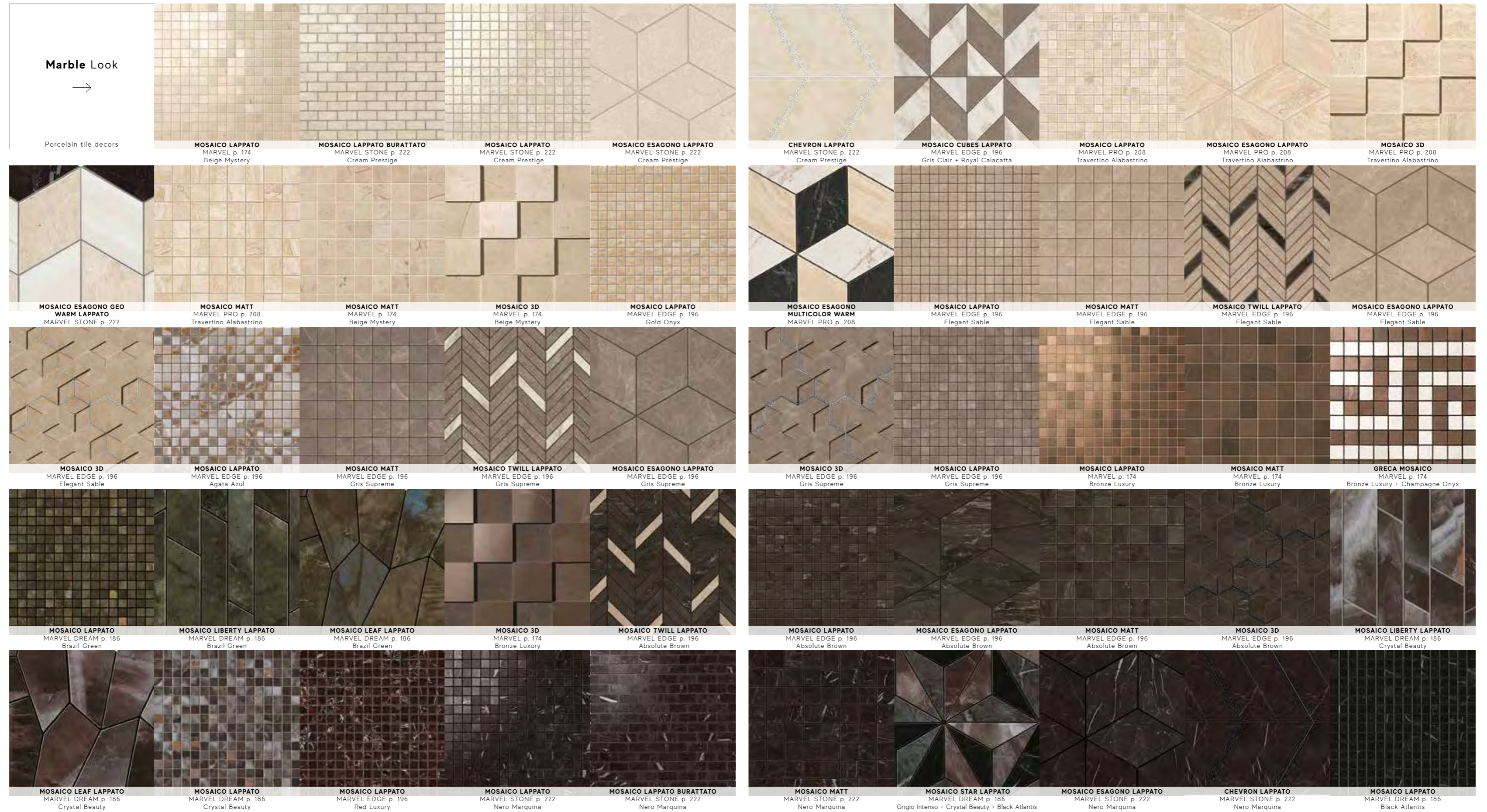

Porcelain tile decors | Marble Look

Decori in gres porcellanato



Porcelain tile decors | Concrete + Resin Look

Decori in gres porcellanato

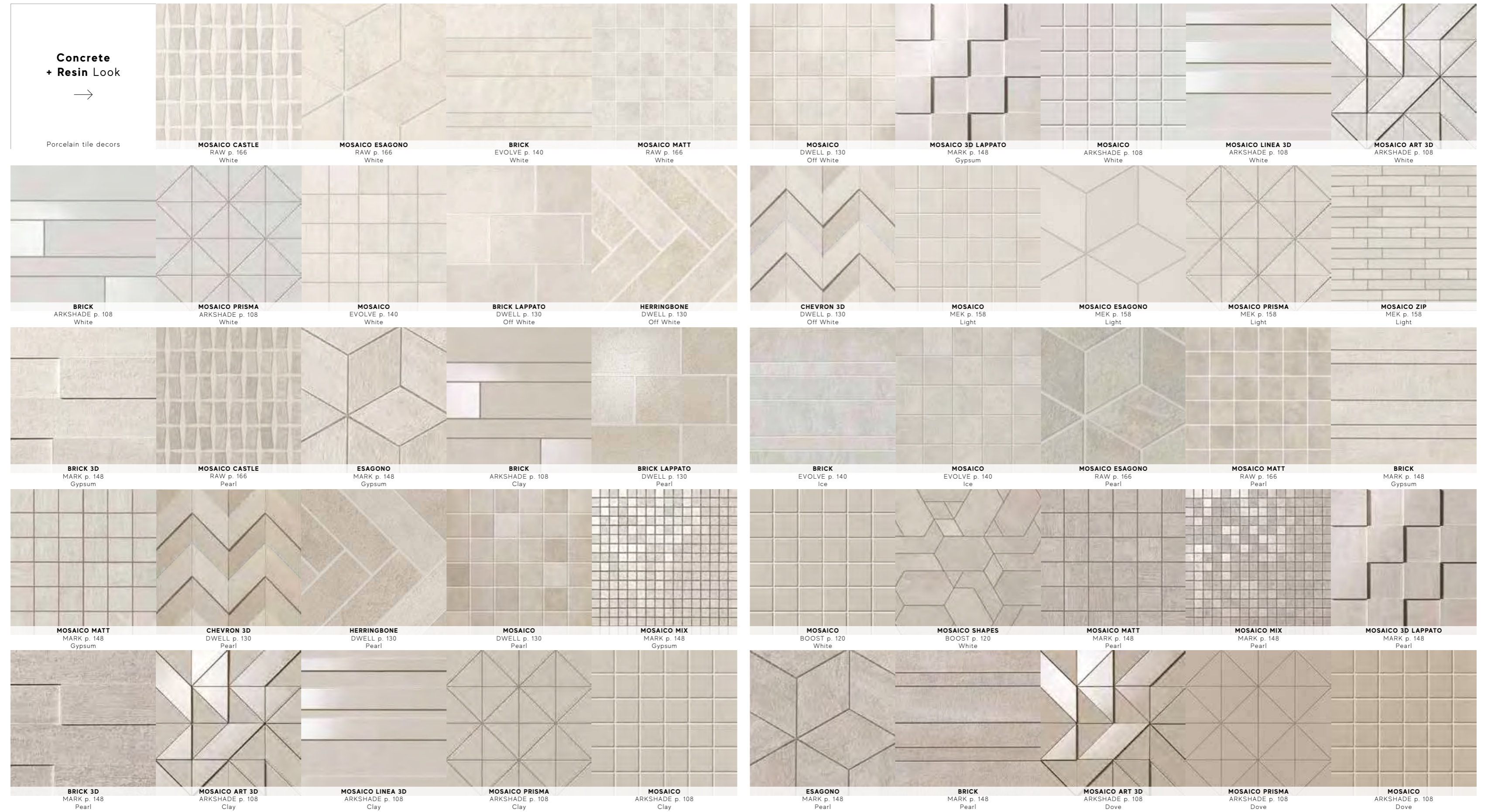

Porcelain tile decors | Concrete + Resin Look

Decori in gres porcellanato



Porcelain tile decors | Concrete + Resin Look

Decori in gres porcellanato

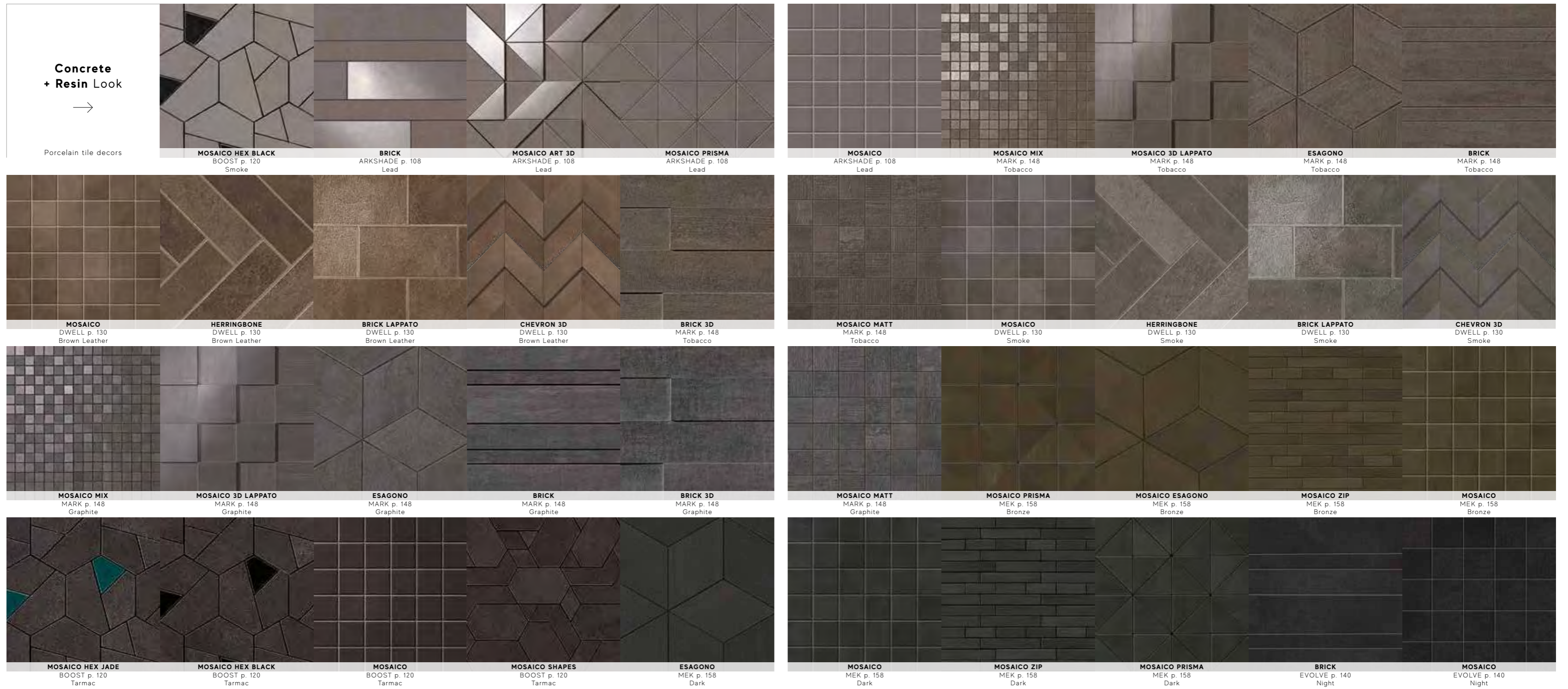

Porcelain tile decors | Metal Look

Decori in gres porcellanato

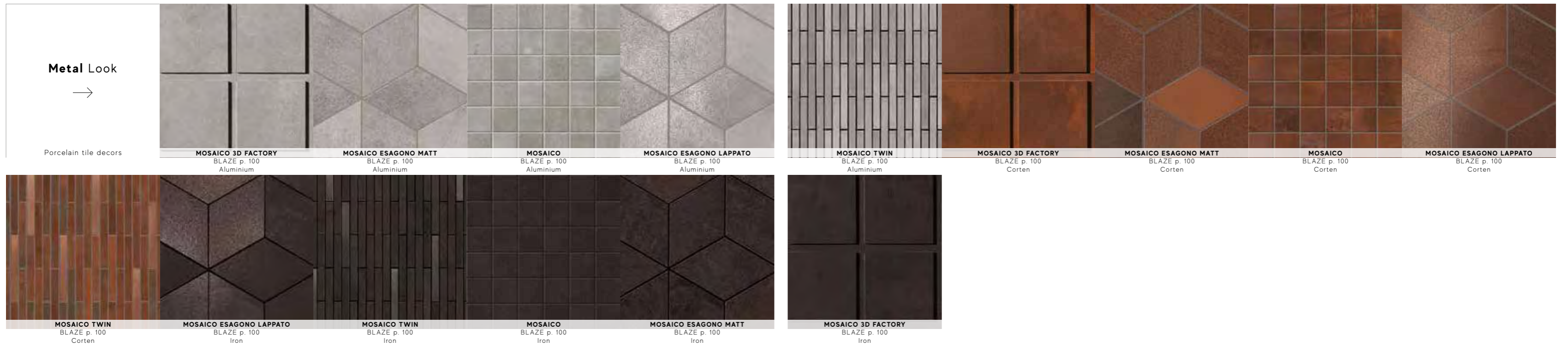

Porcelain tile decors | Stone Look

Decori in gres porcellanato

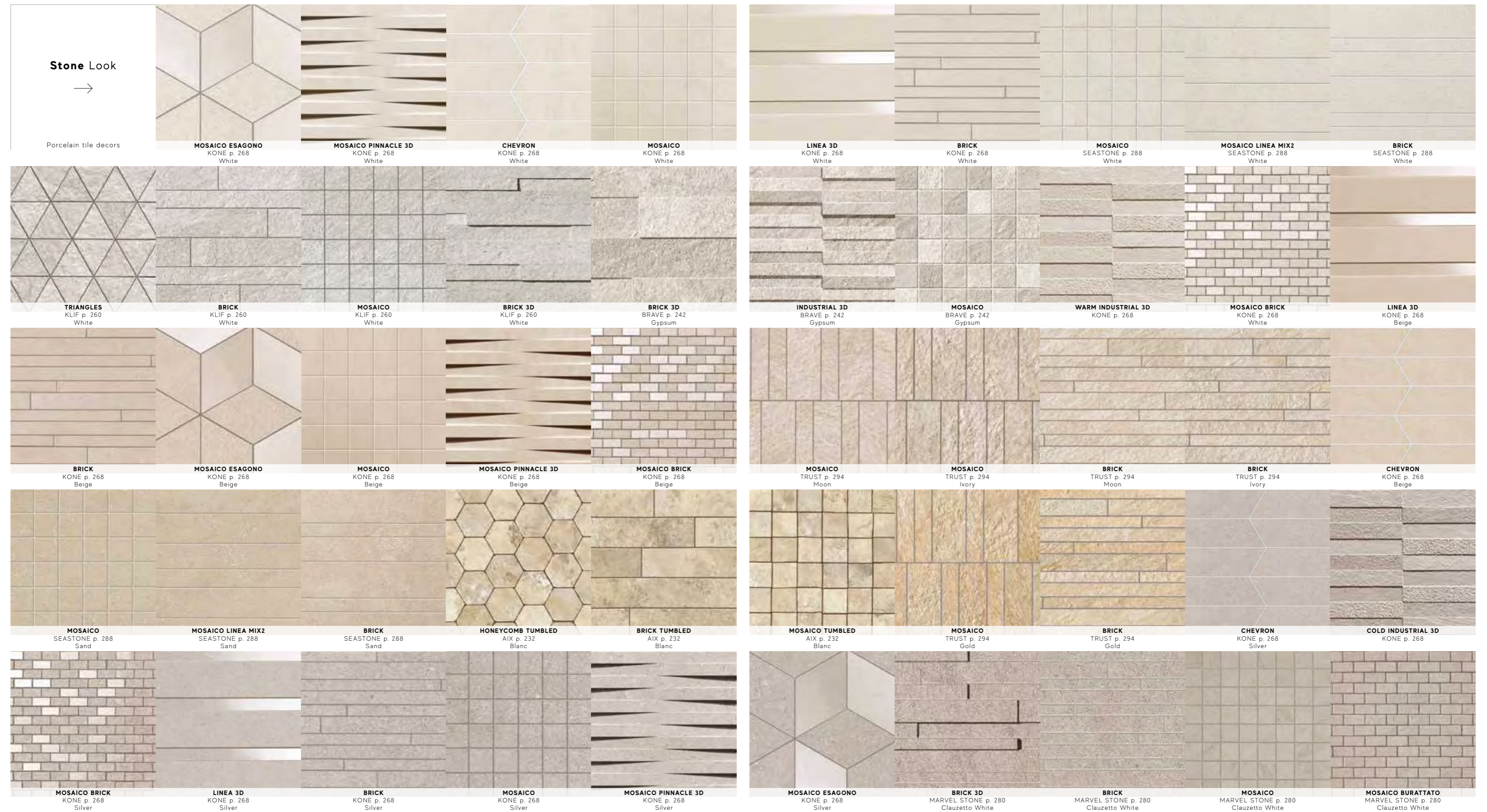

Porcelain tile decors | Stone Look

Decori in gres porcellanato

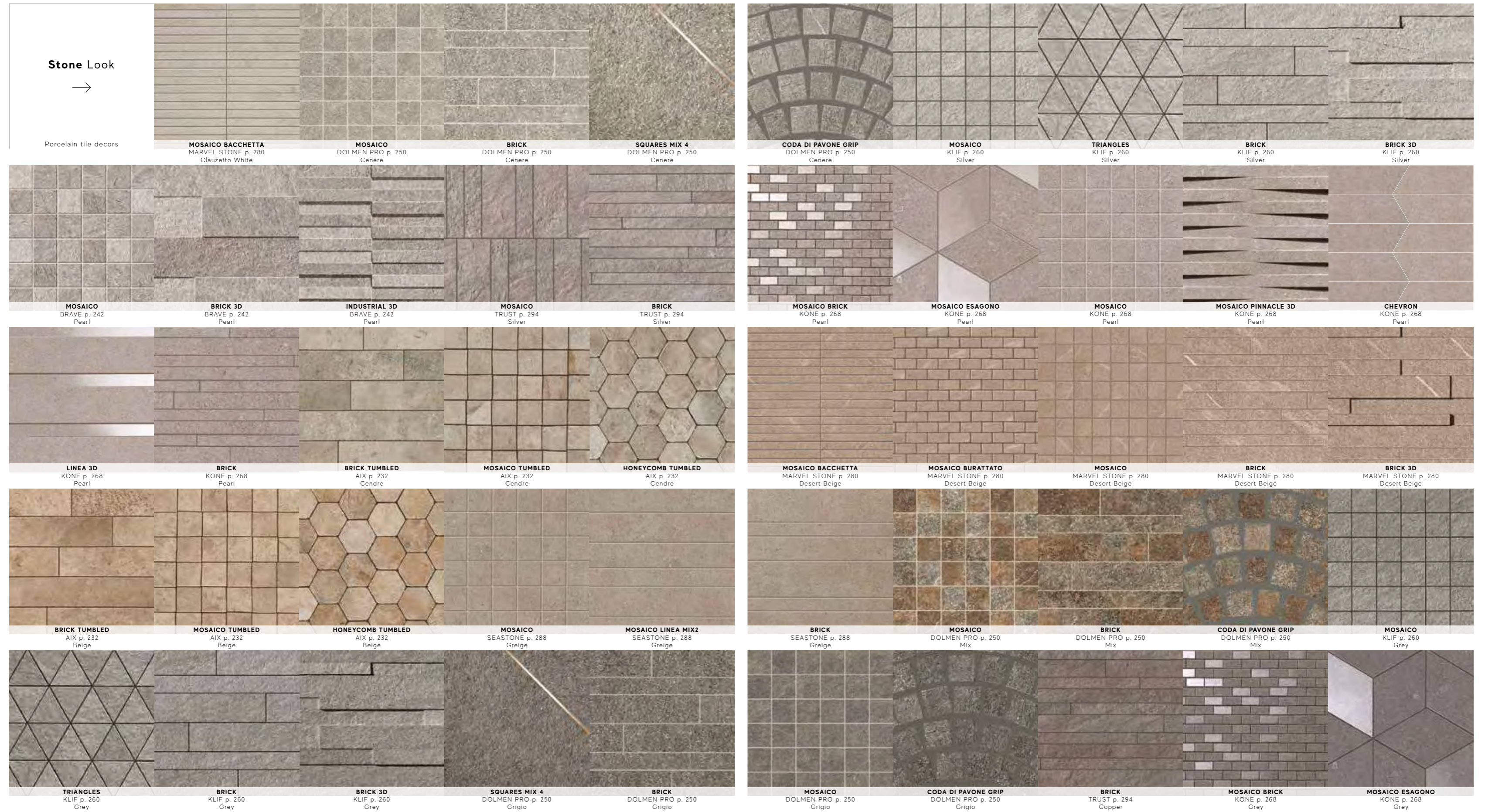

Porcelain tile decors | Stone Look

Decori in gres porcellanato

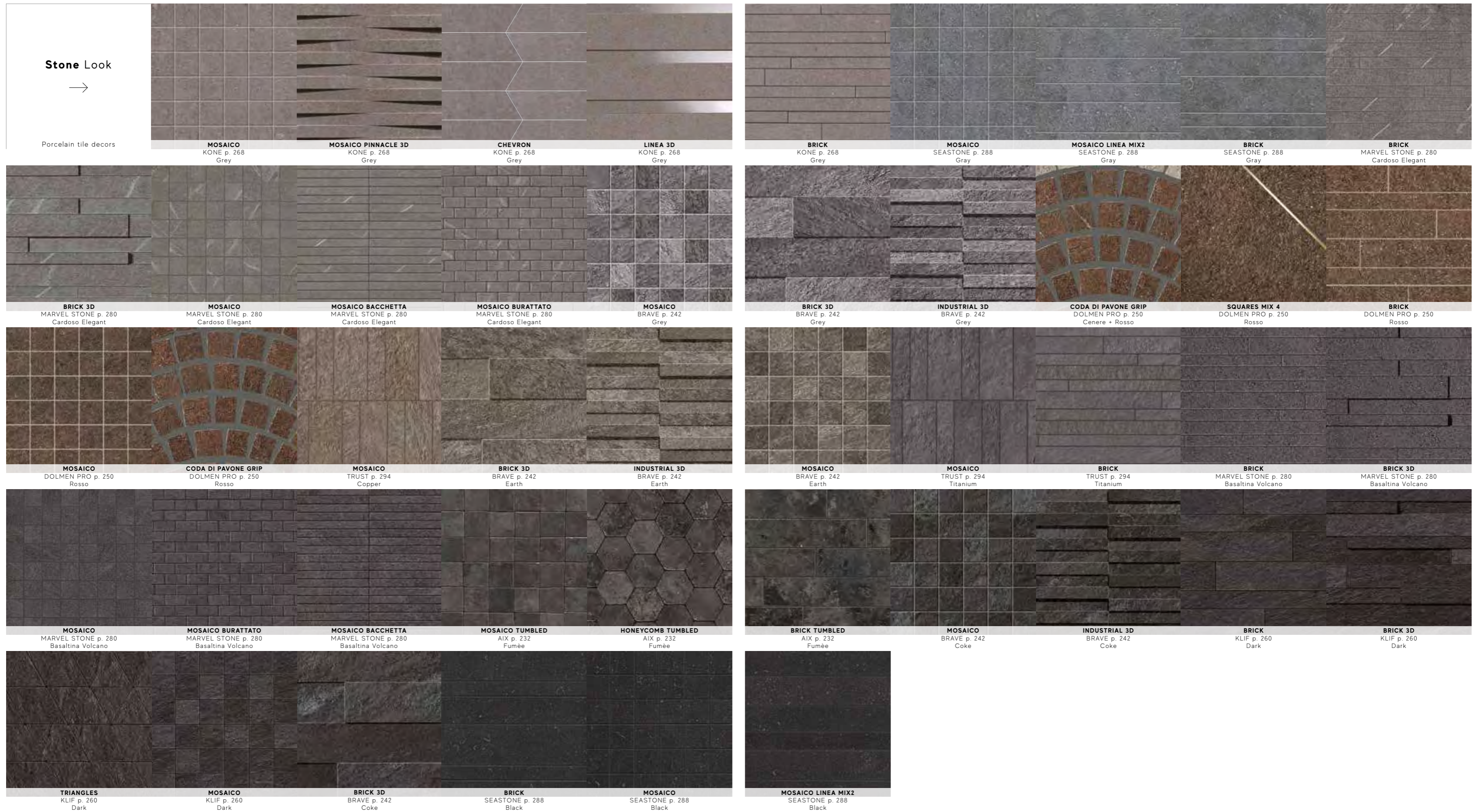

Porcelain tile decors | Wood Look

Decori in gres porcellanato

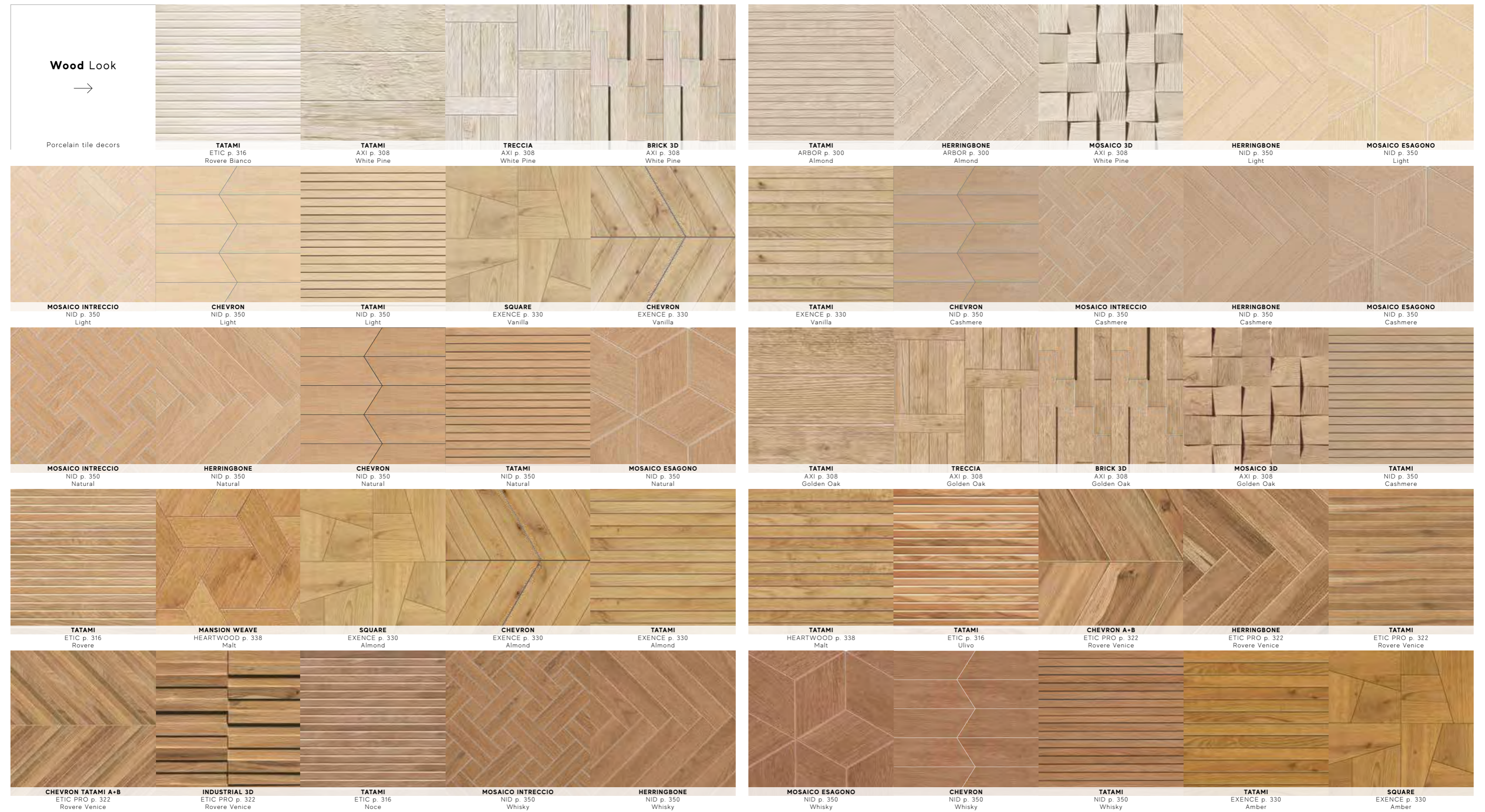

Porcelain tile decors | Wood Look

Decori in gres porcellanato



Porcelain tile decors | Wood Look

Decori in gres porcellanato



Wall tile decors | Marble Look

Decori da rivestimento

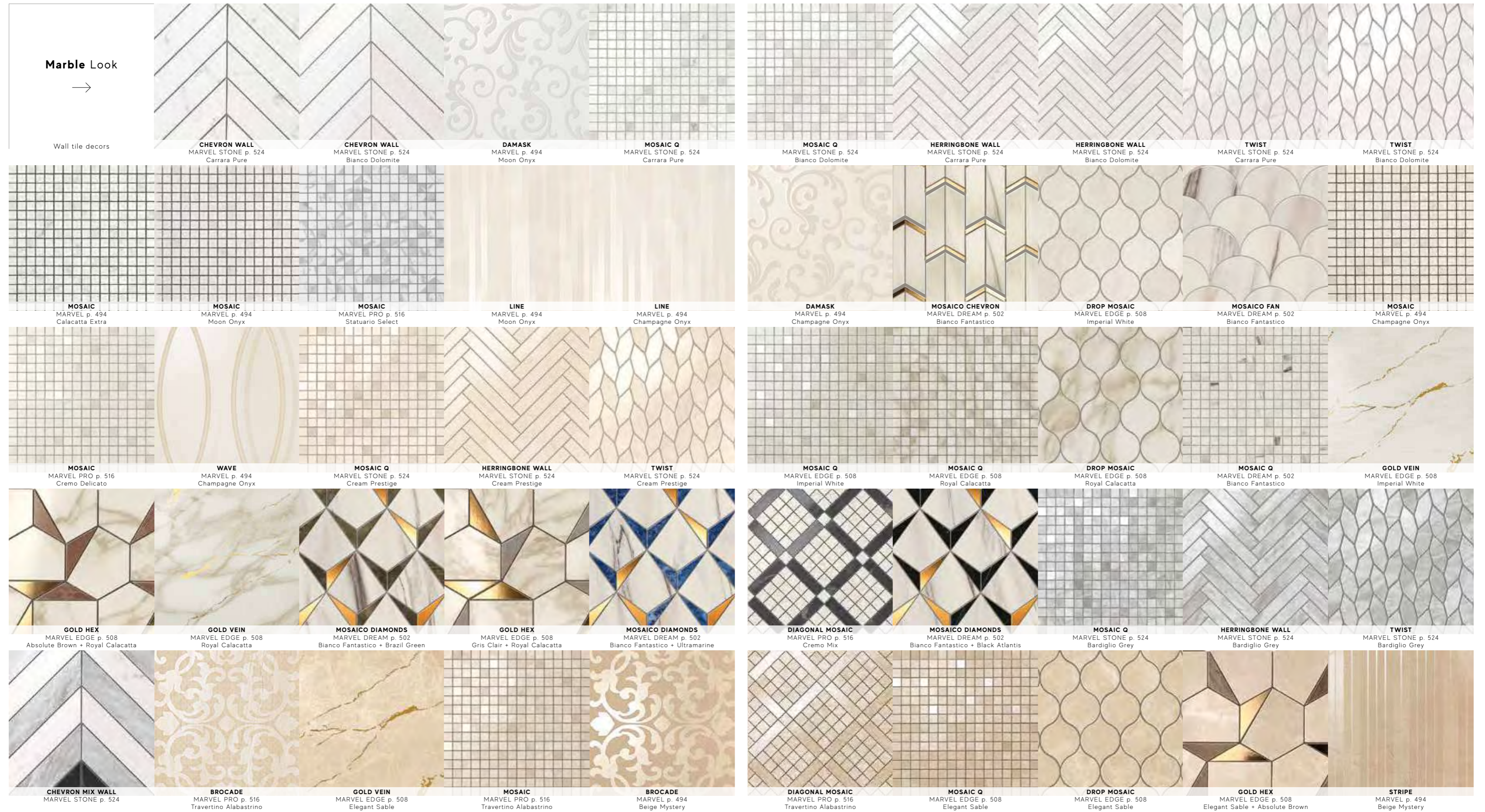

Wall tile decors | Marble Look

Decori da rivestimento

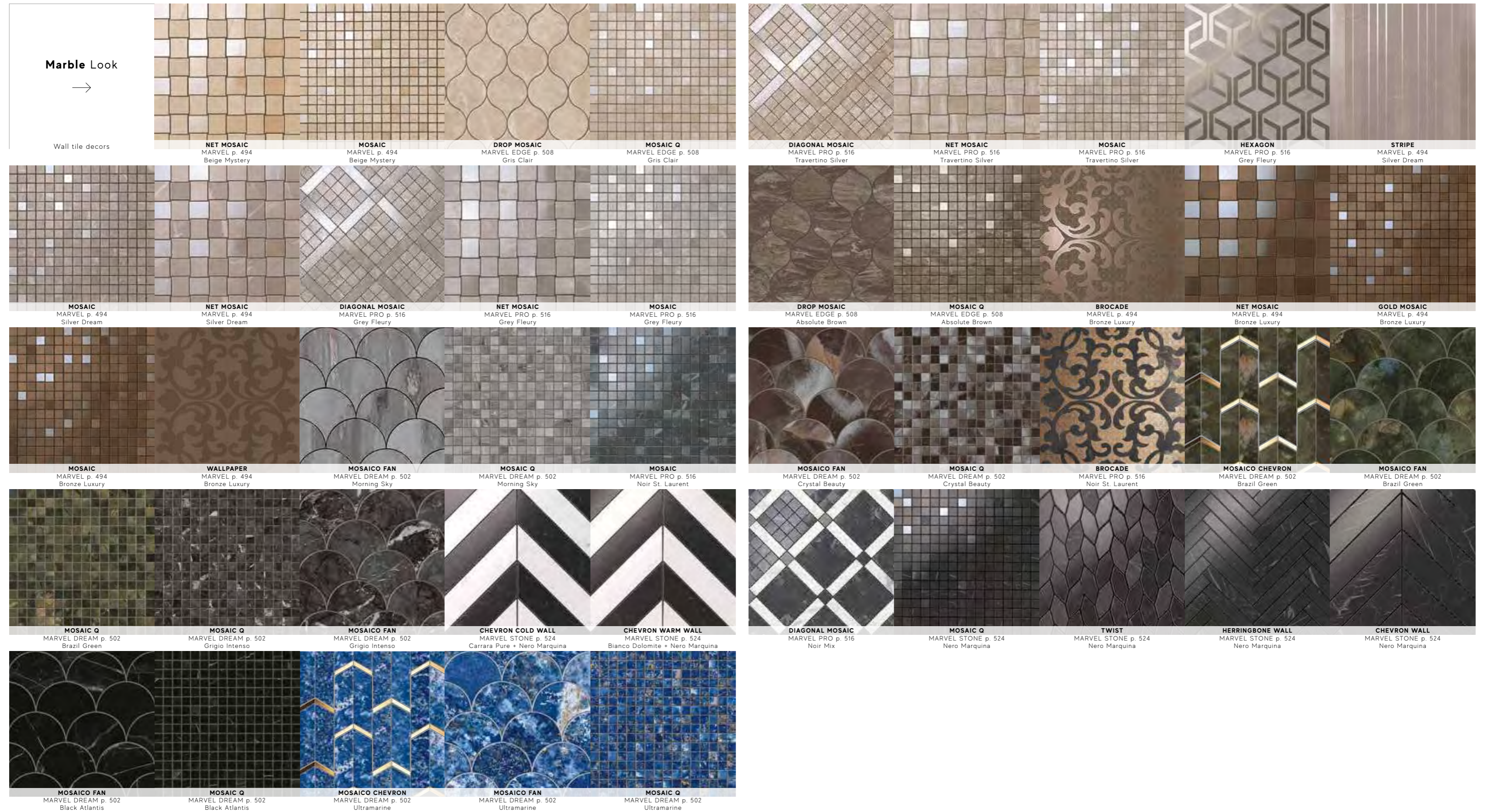

Wall tile decors | Concrete + Resin + Metal Look

Decori da rivestimento



Wall tile decors | Concrete + Resin + Metal Look

Decori da rivestimento

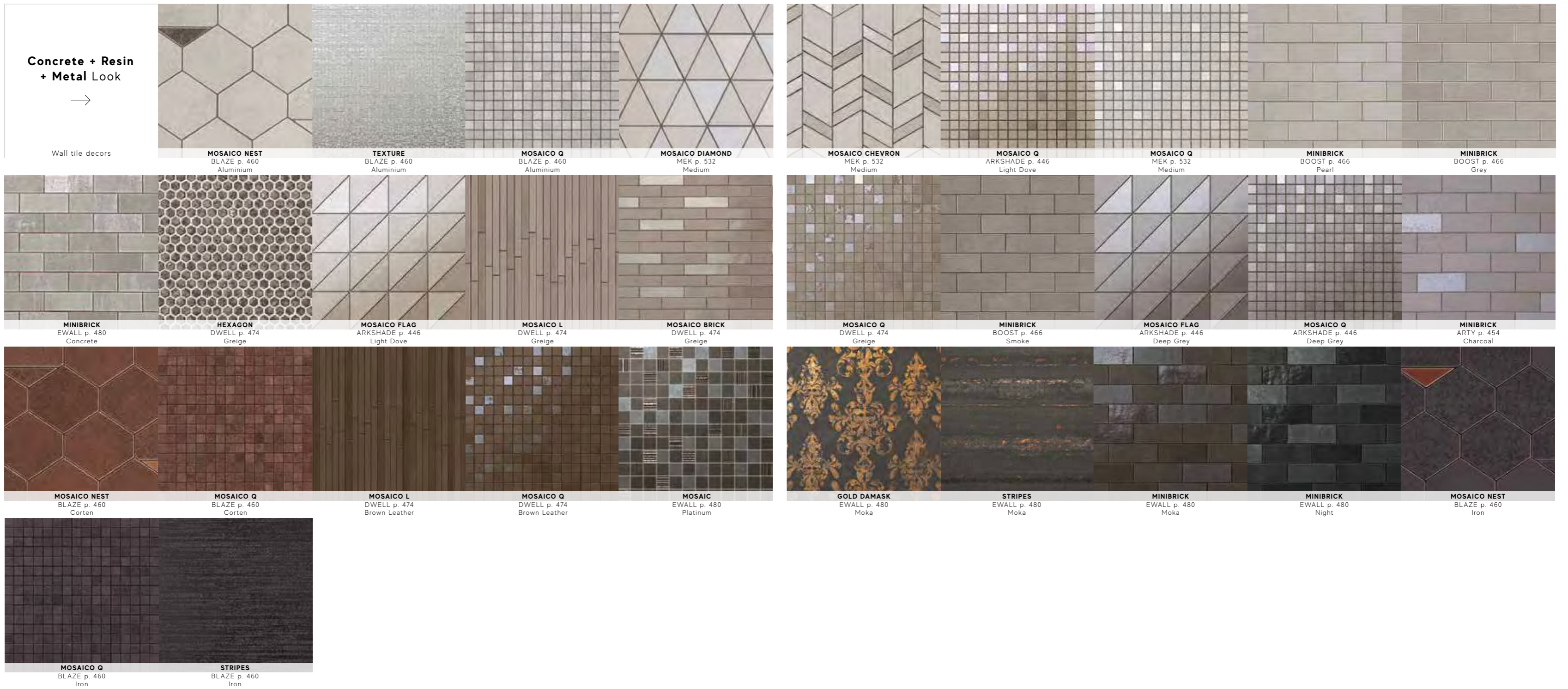

Wall tile decors | Color Look

Decorati da rivestimento

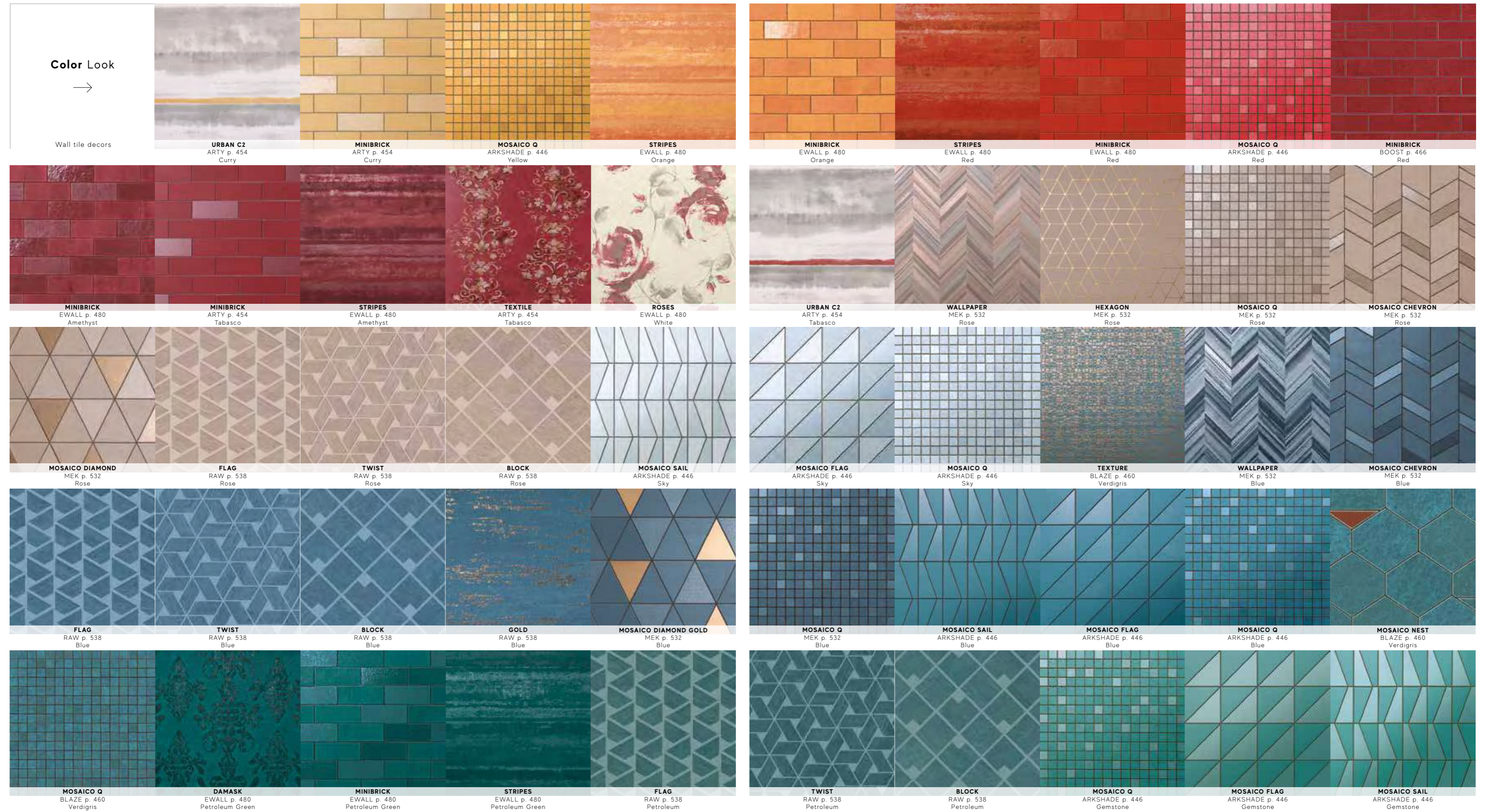

Wall tile decors | Color Look

Decori da rivestimento

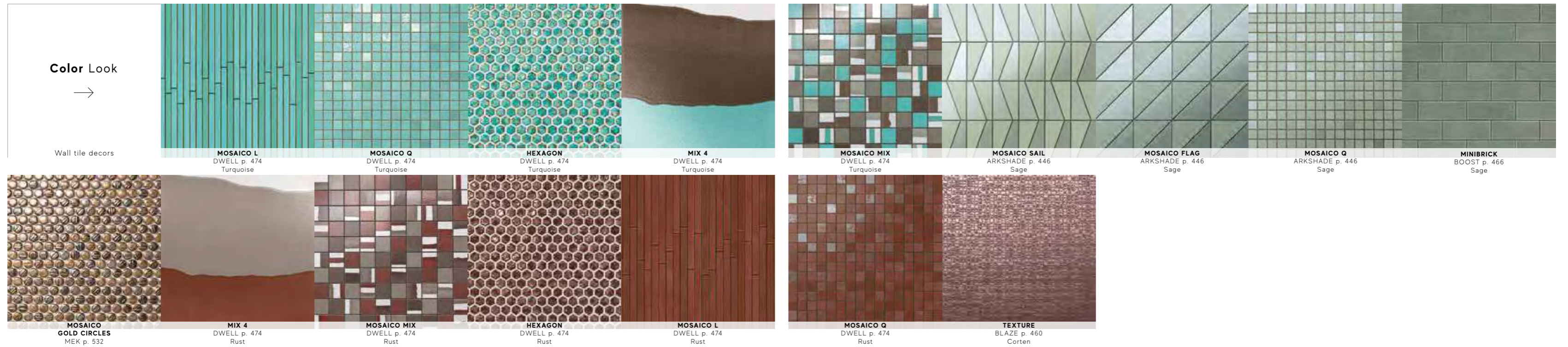

Wall tile decors | Stone Look

Decori da rivestimento



PORCELAIN AND WALL TILES

A SAFE CHOICE

RESISTANCE AND DURATION

SEE PAGE 548 FOR OTHER LANGUAGES / VAI A PAGINA 548 PER LE ALTRE LINGUE

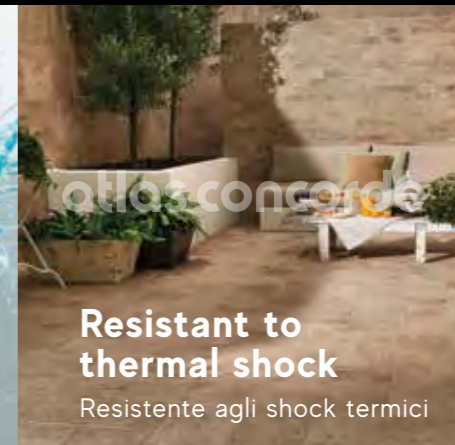

HEALTH

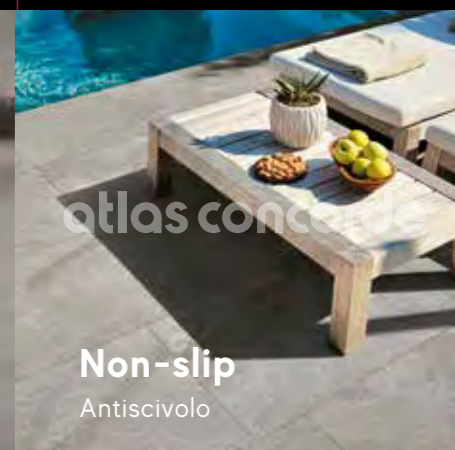
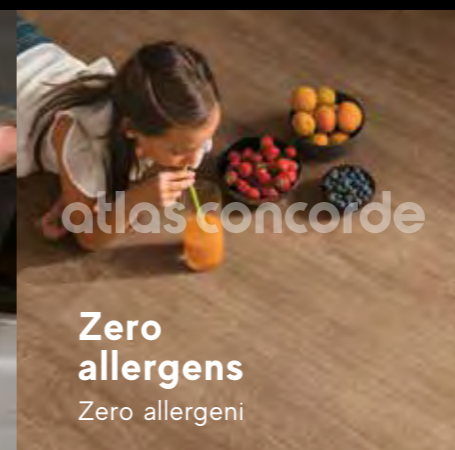
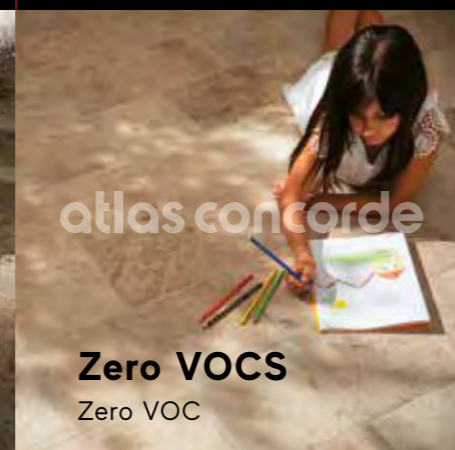

SAFETY

ENVIRONMENT

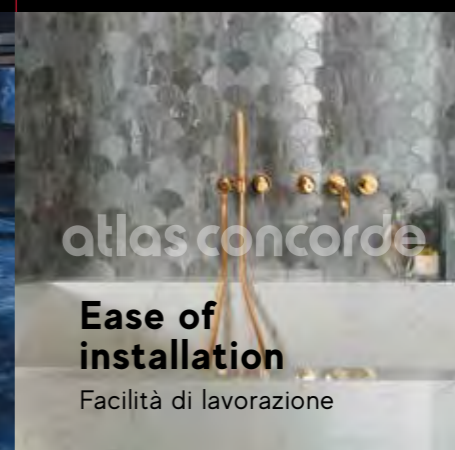
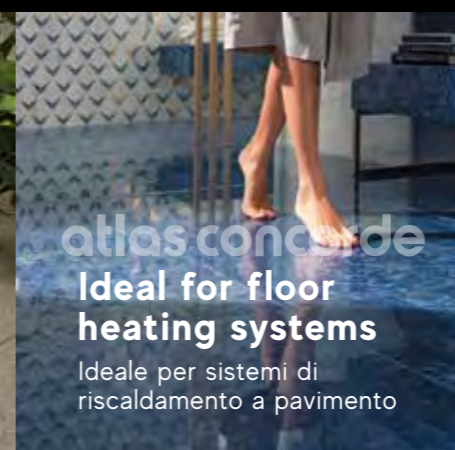
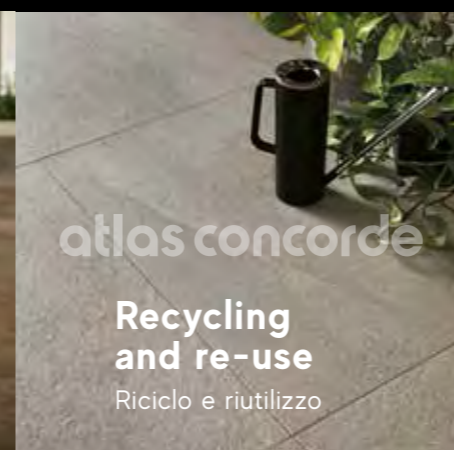
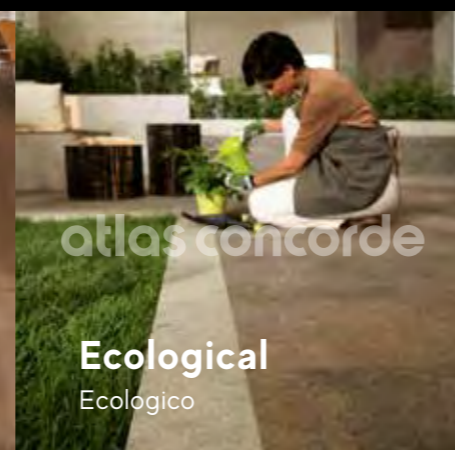
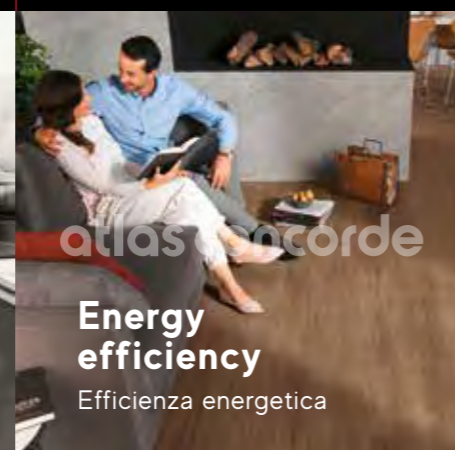

WALL TILES BENEFITS



2020 Collections

DECOR COLLECTION

94 CANONE INVERSO | Piero Lissoni Porcelain Tiles

METAL LOOK

100 BLAZE Porcelain & Wall Tiles

CONCRETE + RESIN LOOK

108 ARKSHADE Porcelain & Wall Tiles
 120 BOOST Porcelain & Wall Tiles
 130 DWELL Porcelain & Wall Tiles
 140 EVOLVE & EWALL Porcelain & Wall Tiles
 148 MARK Porcelain Tiles
 158 MEK Porcelain & Wall Tiles
 166 RAW Porcelain & Wall Tiles

MARBLE LOOK

174 MARVEL Porcelain & Wall Tiles
 186 MARVEL DREAM Porcelain & Wall Tiles
 196 MARVEL EDGE Porcelain & Wall Tiles
 206 MARVEL GEMS Porcelain Tiles
 208 MARVEL PRO Porcelain & Wall Tiles
 222 MARVEL STONE Porcelain & Wall Tiles

STONE LOOK

232 AIX Porcelain & Wall Tiles
 242 BRAVE Porcelain & Wall Tiles
 250 DOLMEN PRO Porcelain Tiles
 258 ECHO Porcelain Tiles
 260 KLIF Porcelain & Wall Tiles
 268 KONE Porcelain & Wall Tiles
 280 MARVEL STONE Porcelain & Wall Tiles
 288 SEASTONE Porcelain Tiles
 294 TRUST Porcelain Tiles

WOOD LOOK

300 ARBOR Porcelain & Wall Tiles
 308 AXI Porcelain Tiles
 316 ETIC Porcelain Tiles
 322 ETIC PRO Porcelain Tiles
 330 EXENCE Porcelain Tiles
 338 HEARTWOOD Porcelain Tiles
 344 NASH Porcelain Tiles
 350 NID Porcelain & Wall Tiles

FABRIC LOOK

356 ROOM Porcelain Tiles

362 GRANIGLIATI Porcelain Tiles
 364 GREENCOLORS Porcelain Tiles
 365 GROUNDTRACK Porcelain Tiles

LARGE SIZES

366 XL Range Porcelain Tiles

OUTDOOR DESIGN

408 Outdoor Range Porcelain Tiles

atlas concorde

atlas concorde

Piero Lissoni
Canone Inverso

PORCELAIN TILES

The first Atlas Concorde decor collection

by Piero Lissoni

Each decoration goes perfectly with the collection it is made from.

Canone Inverso reflects a combination of fluidity and materiality. It interprets the vision that Atlas Concorde had given Piero Lissoni: create decorative elements for wall and floor tiles. The collection offers designers the possibility of combining each module/mosaic with Atlas Concorde floor and wall tiles.

Canone Inverso riflette una combinazione di fluidità e matericità e si fa interprete del pensiero progettuale che Atlas Concorde ha condiviso con Piero Lissoni: ideare elementi decorativi, mosaici, tagli, per rivestimenti murali e da pavimento. La collezione offre ai progettisti la possibilità di abbinare ciascun modulo/mosaico ai rivestimenti per pavimento e per pareti di Atlas Concorde.

"The four compositions of the Canone Inverso collection are the variants of a model, a scheme that is composed and recomposed to create a harmonious relationship that like in a musical score is formed by the assembly of different notes, or rather the forms that make it up".

"Le quattro composizioni della collezione Canone Inverso sono le varianti di un modello, uno schema che viene composto e ricomposto per dare vita a un rapporto armonico che, come in una partitura musicale, è formato dall'assemblaggio delle diverse note, ovvero dalle forme che lo costituiscono."

Canone Inverso 1



Canone Inverso 2



Canone Inverso 3

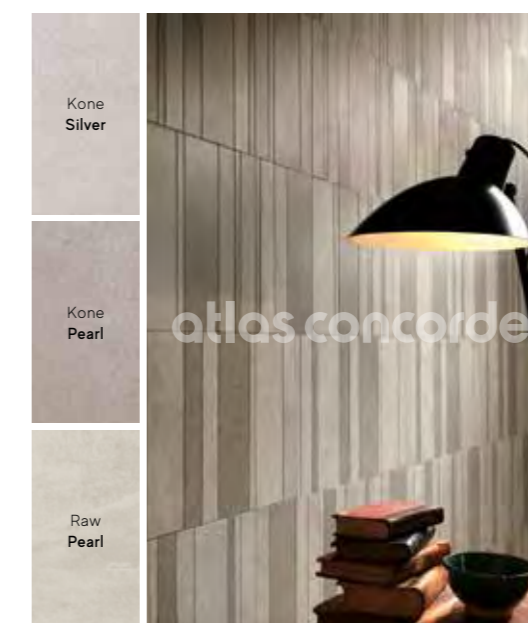

Canone Inverso 4



Canone Inverso Porcelain Tiles / Gres Porcellanato

Canone Inverso 1



81x32 cm 31⁷/₈"x12⁵/₈"
A19U Canone Inverso 1



Canone Inverso 2

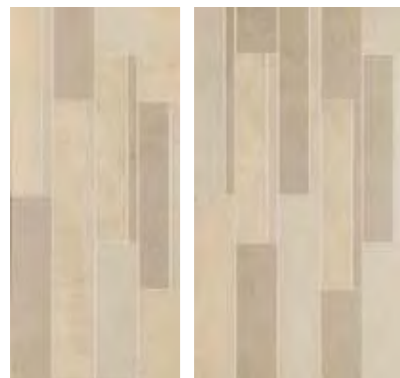

59x59 cm 23"x23"
A19V Canone Inverso 2



Canone Inverso 3



47x147 cm 18¹/₂"x57¹/₈"
A2US Canone Inverso 3

Canone Inverso 4



59x78 cm 23¹/₄"x30³/₄"
A19X Canone Inverso 4





atlas concorde



atlas concorde



atlas concorde



atlas concorde

atlas concorde

BLAZE

PORCELAIN & WALL TILES

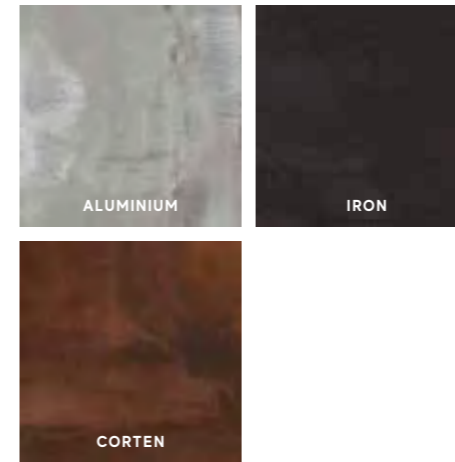

Porcelain Tiles / Gres Porcellanato

COLOURED BODY PORCELAIN TILES - RECTIFIED MONOCALIBER
GRES PORCELLANATO COLORATO IN MASSA - RETTIFICATO MONOCALIBRO

LARGE SIZES p. 366

Sizes	Thickness	Surface finish
120x278 cm - 47 ¹ / ₄ "x109 ¹ / ₂ "	± 6 mm	Matte R9 A
120x120 cm - 47 ¹ / ₄ "x47 ¹ / ₄ "	± 9 mm	Matte R10 A+B
75x150 cm - 29 ¹ / ₂ "x59"	± 9 mm	Polished Matte R10 A+B
75x75 cm - 29 ¹ / ₂ "x29 ¹ / ₂ "	± 9 mm	Polished Matte R10 A+B
37,5x75 cm - 14 ³ / ₄ "x29 ¹ / ₂ "	± 9 mm	Matte R10 A+B

Outdoor Paving and Wet Areas

OUTDOOR PAVING p. 408

Sizes	Thickness	Surface finish
37,5x75 cm - 14 ³ / ₄ "x29 ¹ / ₂ "	± 9 mm	Grip R11 A+B+C
120x120 cm - 47 ¹ / ₄ "x47 ¹ / ₄ "	± 20 mm	Textured R11 A+B+C
60x60 cm - 23 ⁵ / ₈ "x23 ⁵ / ₈ "	± 20 mm	Textured R11 A+B+C

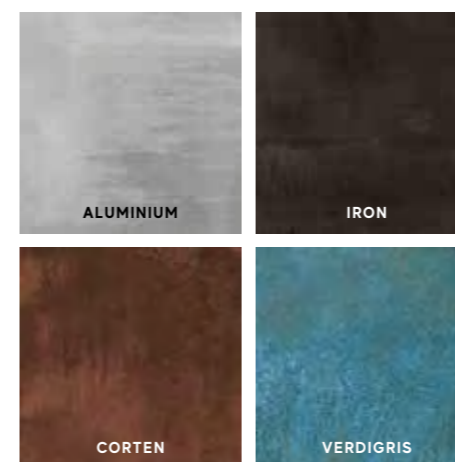

Wall tiles / Rivestimento p. 460

WHITEBODY WALL TILES - RECTIFIED MONOCALIBER
RIVESTIMENTI IN PASTA BIANCA - RETTIFICATO MONOCALIBRO

Sizes	Thickness	Surface finish
50x110 cm - 19 ⁵ / ₈ "x43 ¹ / ₄ "	± 8,5 mm	Matte



Blaze Porcelain Tiles / Gres Porcellanato

MATTE SURFACE / SUPERFICIE MATT



120x278 cm 47¹/₄"x109¹/₂"
 APO7 Blaze Aluminium 120x278
 APO8 Blaze Corten 120x278
 APO9 Blaze Iron 120x278

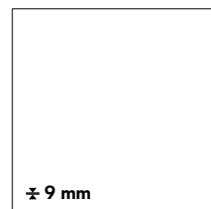

120x120 cm 47¹/₄"x47¹/₄"
 APPK Blaze Aluminium 120x120
 APPW Blaze Corten 120x120
 APPX Blaze Iron 120x120

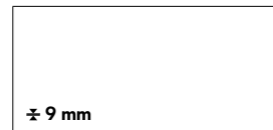

75x150 cm 29¹/₂"x59"
 APNY Blaze Aluminium 75x150
 APNZ Blaze Corten 75x150
 APNØ Blaze Iron 75x150

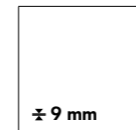

75x75 cm 29¹/₂"x29¹/₂"
 APOU Blaze Aluminium 75x75
 APOV Blaze Corten 75x75
 APOW Blaze Iron 75x75

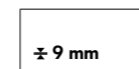

37,5x75 cm 14³/₄"x29¹/₂"
 APOØ Blaze Aluminium 37,5x75
 APO5 Blaze Corten 37,5x75
 APO6 Blaze Iron 37,5x75



POLISHED SURFACE / SUPERFICIE LAPPATA



75x150 cm 29¹/₂"x59"
 APOR Blaze Aluminium 75x150 Lapp
 APOS Blaze Corten 75x150 Lapp
 APOT Blaze Iron 75x150 Lapp

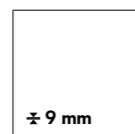

75x75 cm 29¹/₂"x29¹/₂"
 APOX Blaze Aluminium 75x75 Lapp
 APOY Blaze Corten 75x75 Lapp
 APOZ Blaze Iron 75x75 Lapp



GRIP SURFACE / SUPERFICIE GRIP

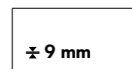

37,5x75 cm 14³/₄"x29¹/₂"
 AØID Blaze Aluminium 37,5x75 Grip
 AØIF Blaze Corten 37,5x75 Grip
 AØIG Blaze Iron 37,5x75 Grip



OUTDOOR PAVING ± 20 mm / PAVIMENTI DA ESTERNO ± 20 mm

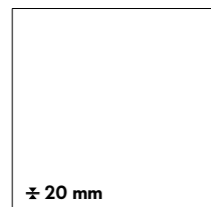

120x120 cm 47¹/₄"x47¹/₄"
 AØ5F Blaze Corten 120x120 20 mm

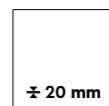

60x60 cm 23⁵/₈"x23⁵/₈"
 AØ5G Blaze Corten 60x60 20 mm



**V3
 MODERATE
 VARIATION**
 Aluminium,
 Corten,
 Iron

MATTE / GRIP



CORTEN

POLISHED



CORTEN

OUTDOOR PAVING ± 20 mm



CORTEN



ALUMINIUM



ALUMINIUM



IRON



IRON

The glossy polished finish is suitable for residential or low-traffic commercial floors, where no anti-slip performance is required, and for walls. The glossy polished surface finish, surprisingly brilliant and bright, features slight irregularities. The extraordinary brilliance and the easy cleaning of the surface are the result of in-depth research aimed at guaranteeing its durability over time. If the product is in direct contact with the outdoors, provide devices for absorbing moisture and dirt to prevent scratches. / La finitura lappata lucida è indicata per pavimenti residenziali o commerciali poco sollecitati, laddove non siano richieste prestazioni antiscivolo, e per rivestimenti. La finitura lappata lucida offre una superficie sorprendentemente brillante e specchiante, con lievi irregolarità. La straordinaria lucentezza e l'elevata pulibilità della superficie sono frutto di studi approfonditi e accurate ricerche tecniche volte a garantirne la persistenza nel tempo. Se il prodotto è a diretto contatto con l'esterno, prevedere dei dispositivi di assorbimento dell'umidità e della sporcizia per prevenire la formazione di graffi.

POLISHED SURFACE | SUPERFICIE LAPPATA | Surface adouci | Geläpft oberfläche | Superficie brufido | Полуполированный поверхность

MATTE SURFACE | SUPERFICIE MATT | Surface Mat | Matt oberfläche | Superficie Mate | Матовая поверхность

GRIP SURFACE | SUPERFICIE GRIP | Surface grip | Grip oberfläche | Superficie Grip | Grip поверхность

OUTDOOR PAVING | PAVIMENTI DA ESTERNO | Sols d'extérieur | Bodenbeläge für Außenbereiche | Pavimentos para exteriores | Уличная плитка

Blaze Porcelain Tiles / Gres Porcellanato

DECOR RANGE / GAMMA DECORI



A0UR Blaze Aluminium
Mosaico 3D Factory
29x29 - 11³/₈"x11³/₈"

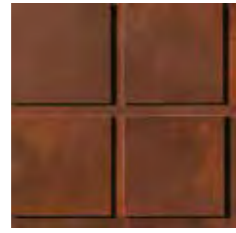

A0US Blaze Corten
Mosaico 3D Factory
29x29 - 11³/₈"x11³/₈"

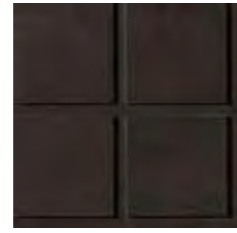

A0UT Blaze Iron
Mosaico 3D Factory
29x29 - 11³/₈"x11³/₈"

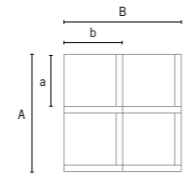

A 29 cm - 11³/₈"
a 12,9 cm - 5¹/₈"
B 29 cm - 11³/₈"
b 14,5 cm - 5⁷/₁₆"



A0UL Blaze Aluminium
Mosaico Esagono Lapp
35,2x30,5 - 13⁷/₈"x12"



A0UM Blaze Corten
Mosaico Esagono Lapp
35,2x30,5 - 13⁷/₈"x12"



A0UN Blaze Iron
Mosaico Esagono Lapp
35,2x30,5 - 13⁷/₈"x12"

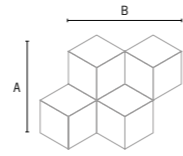

A 30,5 cm - 12"
B 35,2 cm - 13⁷/₈"



A0UO Blaze Aluminium
Mosaico Esagono Matt
35,2x30,5 - 13⁷/₈"x12"



A0UP Blaze Corten
Mosaico Esagono Matt
35,2x30,5 - 13⁷/₈"x12"



A0UQ Blaze Iron
Mosaico Esagono Matt
35,2x30,5 - 13⁷/₈"x12"



A0UX Blaze Aluminium
Mosaico Matt
30x30 - 11³/₄"x11³/₄"

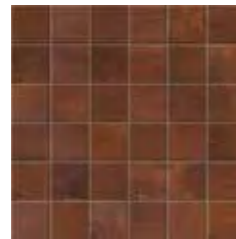

A0UY Blaze Corten
Mosaico Matt
30x30 - 11³/₄"x11³/₄"



A0UZ Blaze Iron
Mosaico Matt
30x30 - 11³/₄"x11³/₄"

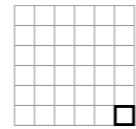

4,8x4,8 cm
1⁷/₈"x1⁷/₈"

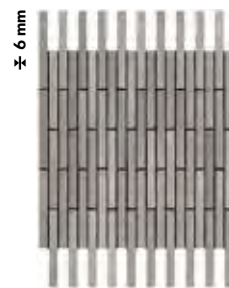

A0UU Blaze Aluminium
Mosaico Twin ♦♦
36,1x29,4 - 14¹/₄"x11⁵/₈"

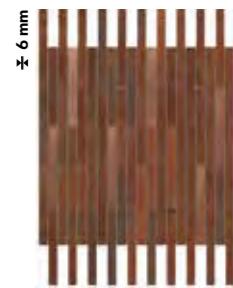

A0UV Blaze Corten
Mosaico Twin ♦♦
36,1x29,4 - 14¹/₄"x11⁵/₈"

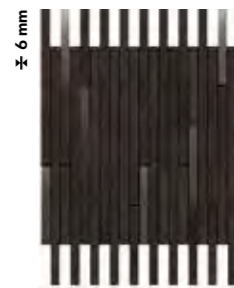

A0UW Blaze Iron
Mosaico Twin ♦♦
36,1x29,4 - 14¹/₄"x11⁵/₈"

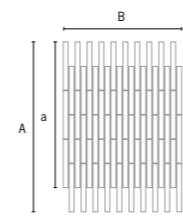

B 29,4 cm - 11⁵/₈"
A 42,1 cm - 16⁵/₈"
a 36 cm - 14¹/₈"



♦ One of the six sheets in the box contains a tile with the Atlas Concorde logo. / Uno dei sei fogli contenuti nella scatola contiene una tessera con logo Atlas Concorde. / Une des six feuilles contenues dans la boîte contient une tesselle décorée du logo Atlas Concorde. / Eines der sechs im Karton enthaltenen Netze enthält einen Mosaikstein mit dem Atlas Concorde-Logo. / Uno dei sei fogli contenuti nella scatola contiene una tessera con logo Atlas Concorde. / En uno de los seis folios que hay dentro de la caja, tiene una tarjeta con el logotipo de Atlas Concorde. / Один из шести листов, помещенных в коробку, содержит табличку с логотипом Atlas Concorde.

* Contains metal. The use of a common mild detergent is recommended. Avoid using acidic or alkaline products, waxes, steel wool, or abrasives. / Parti in metallo. Si consiglia l'utilizzo di un comune detergente neutro. Evitare l'utilizzo di prodotti acidi o alcalini, ceranti e pagliette di metallo o abrasive. / Parties en métal. Nous vous conseillons d'utiliser des détergents neutres courants. Éviter l'utilisation de cires et de produits acides ou alcalins, ainsi que les pailles métalliques ou abrasives. / Metallteile. Es empfiehlt sich, ein haushaltsübliches, neutrales Reinigungsmittel zu verwenden. Saure oder alkalische Produkte, Wachs sowie Stahlwolle- bzw. Scheuerschwämme sind zu vermeiden. / Partes de metal. Recomendamos utilizar un detergente neutro común. Hay que evitar el uso de productos ácidos o alcalinos, ceras y estropajos de metal o abrasivos. / Металлические детали. Рекомендуется чистить обычным нейтральным моющим средством. Не рекомендуется использовать кислотные, щелочные, восковые средства, а также металлические мочалки.

TRIM TILES / PEZZI SPECIALI

p. 424

	Battiscopa		Battiscopa		Gradino *	Scalino *		Scalino *		Scalino Angolare *		Corner ± 6 mm *	Corner A.E. ± 6 mm *	Battiscopa Sag. Scala		Elemento L Grip *
	Lapp.	Matt	Lapp.	Matt		Lapp.	Matt	Lapp.	Matt	Lapp.	Matt			DX *	SX *	
Aluminium	A0IQ	A0IN	A0IK	A0IH	A0IZ	A0JB	A0I8	A0I5	A0I2	A0JH	A0JE	A0UI	A19Y	A0IT	A0IW	A0JK
Corten	A0IR	A0IO	A0IL	A0II	A0I0	A0JC	A0I9	A0I6	A0I3	A0JI	A0JF	A0UJ	A19Z	A0IU	A0IX	A0JL
Iron	A0IS	A0IP	A0IM	A0IJ	A0I1	A0JD	A0JA	A0I7	A0I4	A0JJ	A0JG	A0UK	A190	A0IV	A0IY	A0JM

* THESE PARTS ARE SUPPLIED TO ORDER | PEZZI SONO DISPONIBILI SU ORDINAZIONE | Les pièces sont disponibles sur commande | Die Teile sind auf Bestellung lieferbar | Las piezas se hacen por encargo | Изготавливаются на заказ



Blaze Wall Tiles / Rivestimento

MATTE SURFACE / SUPERFICIE MATT

± 8,5 mm

50x110 cm 19⁵/₈"x43¹/₄"

4B1A Blaze Aluminium 50x110
4B1C Blaze Corten 50x110
4B1R Blaze Iron 50x110
4B1V Blaze Verdigris 50x110

TRIM TILES / PEZZI SPECIALI

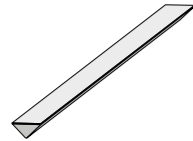

1,4x50 cm - ⁵/₈"x19⁵/₈"

LB5M Blaze Aluminium Corner 50 *
LB5C Blaze Corten Corner 50 *
LB5R Blaze Iron Corner 50 *
LB5V Blaze Verdigris Corner 50 *
LB5S Blaze Iron Stripes Corner 50 *



1,4x1,4 cm - ⁵/₈"x⁵/₈"

A0LA Blaze Aluminium Corner A.E. 1,4 *
A0LC Blaze Corten Corner A.E. 1,4 *
A0LR Blaze Iron Corner A.E. 1,4 *
A0LV Blaze Verdigris Corner A.E. 1,4 *
A0LS Blaze Iron Stripes Corner A.E. 1,4 *

DECORATIVE RANGE / GAMMA DECORATIVA

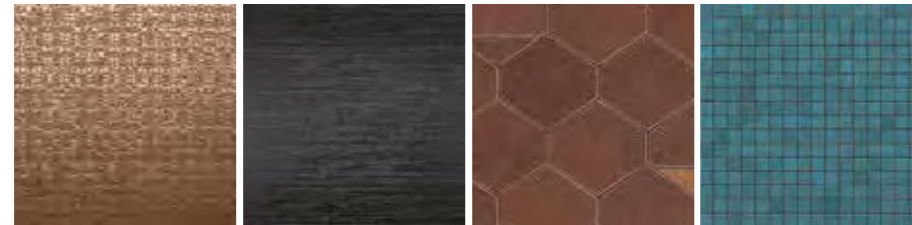

TEXTURE

STRIPES

MOSAICO NEST

MOSAICO Q

* THESE PARTS ARE SUPPLIED TO ORDER . I PEZZI SONO DISPONIBILI SU ORDINAZIONE
Les pièces sont disponibles sur commande | Die Teile sind auf Bestellung lieferbar | Las piezas se hacen por encargo | Изготавливаются на заказ



atlas concorde

MATTE SURFACE | SUPERFICIE MATT | Surface Mat | Matt oberfläche | Superficie Mate | Матовая поверхность

WALL TILES p. 460

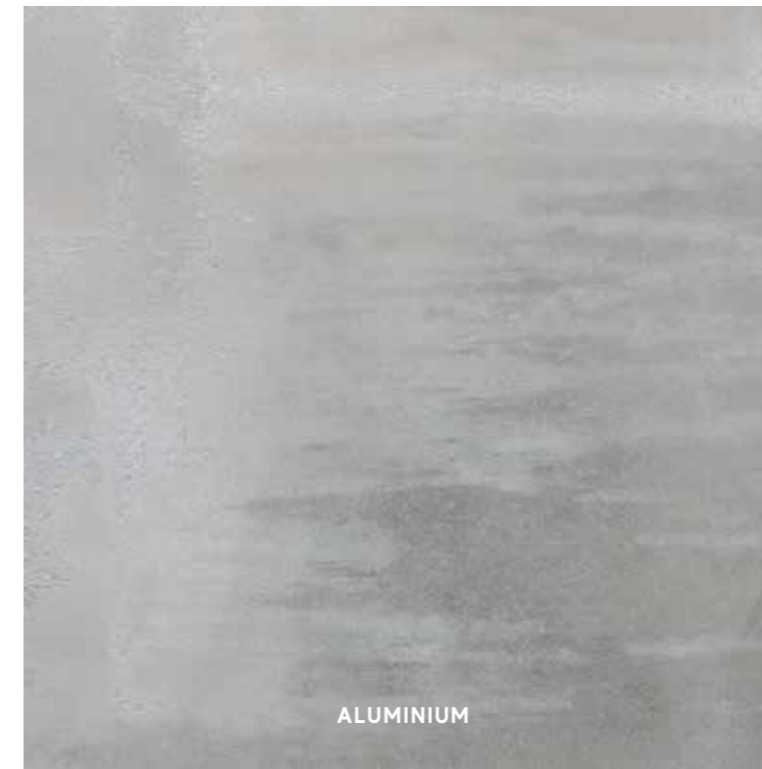

ALUMINIUM

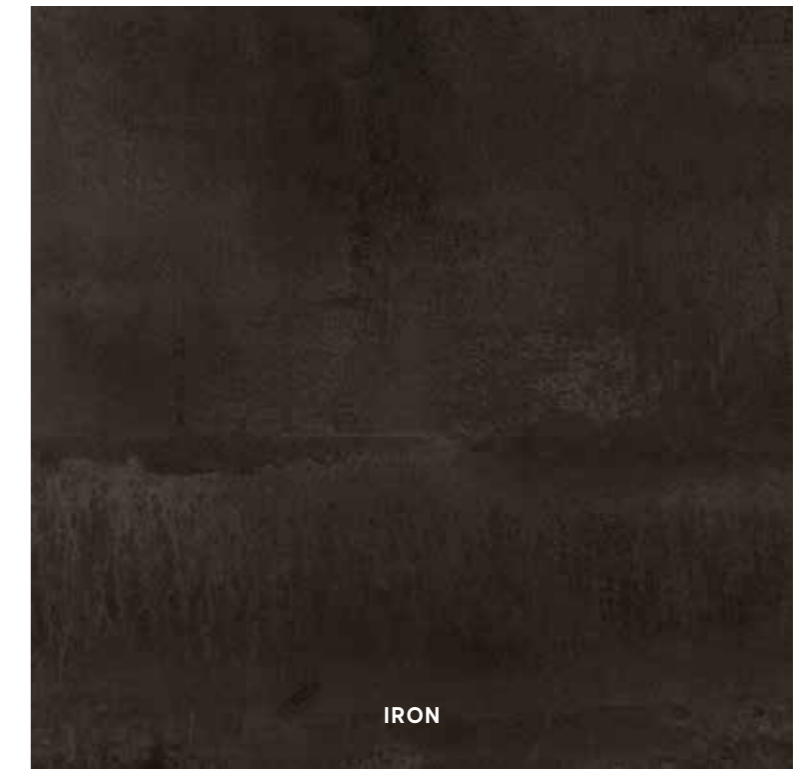

IRON

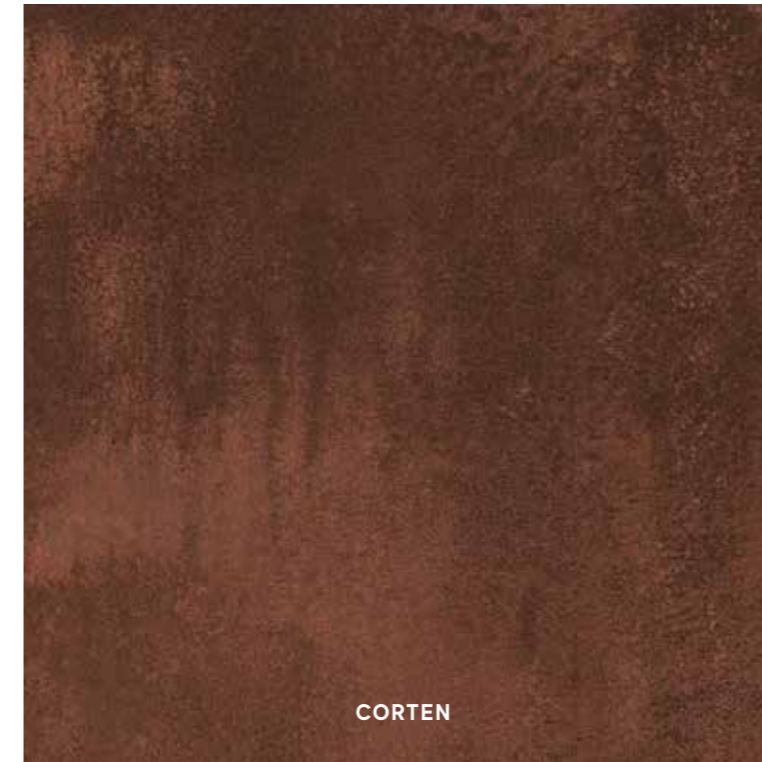

CORTEN



VERDIGRIS



V3
MODERATE
VARIATION
Aluminium,
Corten,
Iron,
Verdigris



ARKSHADE

PORCELAIN & WALL TILES

Porcelain Tiles / Gres Porcellanato

COLOURED BODY PORCELAIN TILES - RECTIFIED MONOCALIBER
GRES PORCELLANATO COLORATO IN MASSA - RETTIFICATO MONOCALIBRO

LARGE SIZES p. 366



Sizes	Thickness	Surface finish
120x240 cm - 47 ¹ / ₄ "x94 ¹ / ₂ "	± 9 mm	Matte R10 A
120x120 cm - 47 ¹ / ₄ "x47 ¹ / ₄ "	± 9 mm	Matte R10 A
75x150 cm - 29 ¹ / ₂ "x59"	± 9 mm	Polished Matte R10 A
75x75 cm - 29 ¹ / ₂ "x29 ¹ / ₂ "	± 9 mm	Polished Matte R10 A
45x90 cm - 17 ³ / ₄ "x35 ³ / ₈ "	± 9 mm	Polished Matte R10 A
60x60 cm - 23 ⁵ / ₈ "x23 ⁵ / ₈ "	± 9 mm	Polished Matte R10 A
30x60 cm - 11 ³ / ₄ "x23 ⁵ / ₈ "	± 9 mm	Polished Matte R10 A

Outdoor Paving and Wet Areas

OUTDOOR PAVING p. 408

Sizes	Thickness	Surface finish
30x60 cm - 11 ³ / ₄ "x23 ⁵ / ₈ "	± 9 mm	Grip R11 A+B

Wall Tiles / Rivestimento p. 446

WHITEBODY WALL TILES - RECTIFIED MONOCALIBER
RIVESTIMENTI IN PASTA BIANCA - RETTIFICATO MONOCALIBRO



Sizes	Thickness	Surface finish
40x80 cm - 15 ³ / ₄ "x31 ¹ / ₂ "	± 8,5 mm	Matte

3D Wall Tiles

Sizes	Thickness	Surface finish
40x80 cm - 15 ³ / ₄ "x31 ¹ / ₂ "	± 10 mm	Matte



Arkshade Porcelain Tiles / Gres Porcellanato

MATTE SURFACE / SUPERFICIE MATT



120x240 cm 47¹/₄"x94¹/₂"
AUGX Arkshade White 120x240
AUGØ Arkshade Grey 120x240

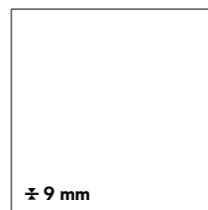

120x120 cm 47¹/₄"x47¹/₄"
AUG1 Arkshade White 120x120
AUG4 Arkshade Grey 120x120

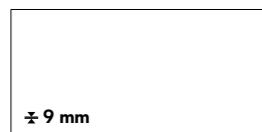

75x150 cm 29¹/₂"x59"
AUF0 Arkshade White 75x150
AUFP Arkshade Clay 75x150
AUFQ Arkshade Dove 75x150
AUFR Arkshade Grey 75x150
AUF5 Arkshade Lead 75x150

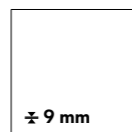

75x75 cm 29¹/₂"x29¹/₂"
AUF7 Arkshade White 75x75
AUFU Arkshade Clay 75x75
AUFV Arkshade Dove 75x75
AUFW Arkshade Grey 75x75
AUFX Arkshade Lead 75x75

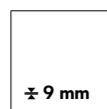

60x60 cm 23³/₈"x23³/₈"
AUF8 Arkshade White 60x60
AUF9 Arkshade Clay 60x60
AUGA Arkshade Dove 60x60
AUGB Arkshade Grey 60x60
AUGC Arkshade Lead 60x60

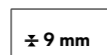

30x60 cm 11³/₄"x23³/₈"
D205 Arkshade White 30x60
D206 Arkshade Clay 30x60
D207 Arkshade Dove 30x60
D208 Arkshade Grey 30x60
D209 Arkshade Lead 30x60

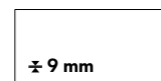

45x90 cm 17³/₄"x35³/₈"
AUFY Arkshade White 45x90
AUFZ Arkshade Clay 45x90
AUFØ Arkshade Dove 45x90
AUF1 Arkshade Grey 45x90
AUF2 Arkshade Lead 45x90



GRIP SURFACE / SUPERFICIE GRIP

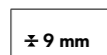

30x60 cm 11³/₄"x23³/₈"
D210 Arkshade White 30x60 Grip
D211 Arkshade Clay 30x60 Grip
D213 Arkshade Dove 30x60 Grip
D214 Arkshade Grey 30x60 Grip
D215 Arkshade Lead 30x60 Grip

MATTE / GRIP

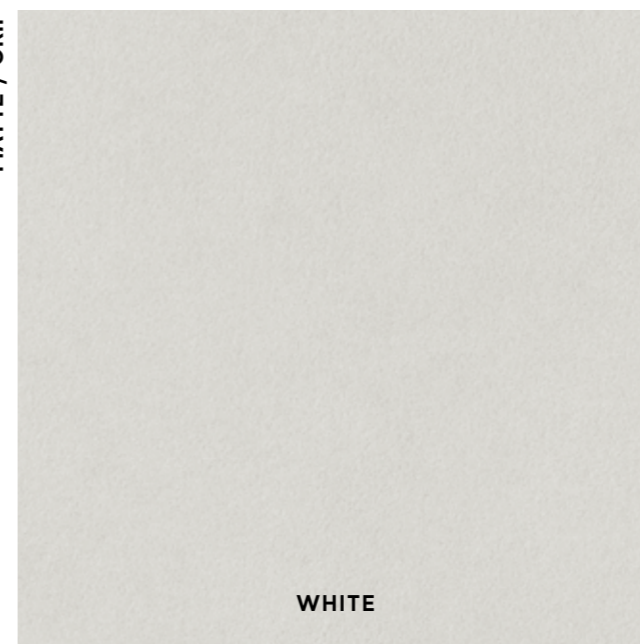

WHITE



GREY



CLAY

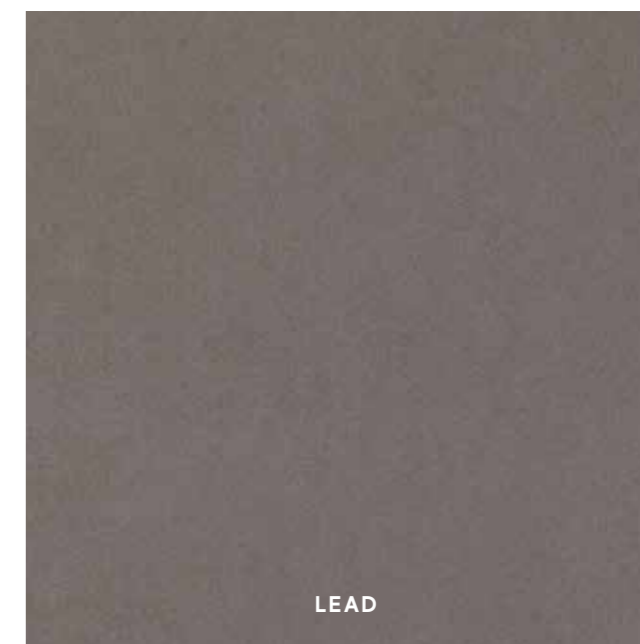

LEAD



DOVE



**V1
UNIFORM
APPEARANCE**

White,
Clay,
Grey,
Dove,
Lead



Arkshade Porcelain Tiles / Gres Porcellanato

POLISHED SURFACE / SUPERFICIE LAPPATA



75x150 cm 29 1/2" x 59"
 AUF E Arkshade White 75x150 Lappato
 AUF F Arkshade Clay 75x150 Lappato
 AUF G Arkshade Dove 75x150 Lappato
 AUF H Arkshade Grey 75x150 Lappato
 AUF I Arkshade Lead 75x150 Lappato

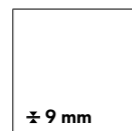

75x75 cm 29 1/2" x 29 1/2"
 AUF J Arkshade White 75x75 Lappato
 AUF K Arkshade Clay 75x75 Lappato
 AUF L Arkshade Dove 75x75 Lappato
 AUF M Arkshade Grey 75x75 Lappato
 AUF N Arkshade Lead 75x75 Lappato

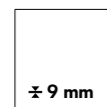

60x60 cm 23 5/8" x 23 5/8"
 AUG D Arkshade White 60x60 Lappato
 AUG E Arkshade Clay 60x60 Lappato
 AUG F Arkshade Dove 60x60 Lappato
 AUG G Arkshade Grey 60x60 Lappato
 AUG H Arkshade Lead 60x60 Lappato

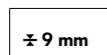

30x60 cm 11 3/4" x 23 5/8"
 D195 Arkshade White 30x60 Lappato
 D196 Arkshade Clay 30x60 Lappato
 D197 Arkshade Dove 30x60 Lappato
 D198 Arkshade Grey 30x60 Lappato
 D199 Arkshade Lead 30x60 Lappato



45x90 cm 17 3/4" x 35 3/8"
 AUF 3 Arkshade White 45x90 Lappato
 AUF 4 Arkshade Clay 45x90 Lappato
 AUF 5 Arkshade Dove 45x90 Lappato
 AUF 6 Arkshade Grey 45x90 Lappato
 AUF 7 Arkshade Lead 45x90 Lappato



The glossy polished finish is suitable for residential or low-traffic commercial floors, where no anti-slip performance is required, and for walls. The glossy polished surface finish, surprisingly brilliant and bright, features slight irregularities. The extraordinary brilliance and the easy cleaning of the surface are the result of in-depth research aimed at guaranteeing its durability over time. If the product is in direct contact with the outdoors, provide devices for absorbing moisture and dirt to prevent scratches. / La finitura lappata lucida è indicata per pavimenti residenziali o commerciali poco sollecitati, laddove non siano richieste prestazioni antiscivolo, e per rivestimenti. La finitura lappata lucida offre una superficie sorprendentemente brillante e specchiante, con lievi irregolarità. La straordinaria lucentezza e l'elevata pulibilità della superficie sono frutto di studi approfonditi e accurate ricerche tecniche volte a garantirne la persistenza nel tempo. Se il prodotto è a diretto contatto con l'esterno, prevedere dei dispositivi di assorbimento dell'umidità e della sporcizia per prevenire la formazione di graffi.

POLISHED SURFACE | SUPERFICIE LAPPATA | Surface adouci | Geläppte Oberfläche | Superficie bruñido | Полуполированный поверхность

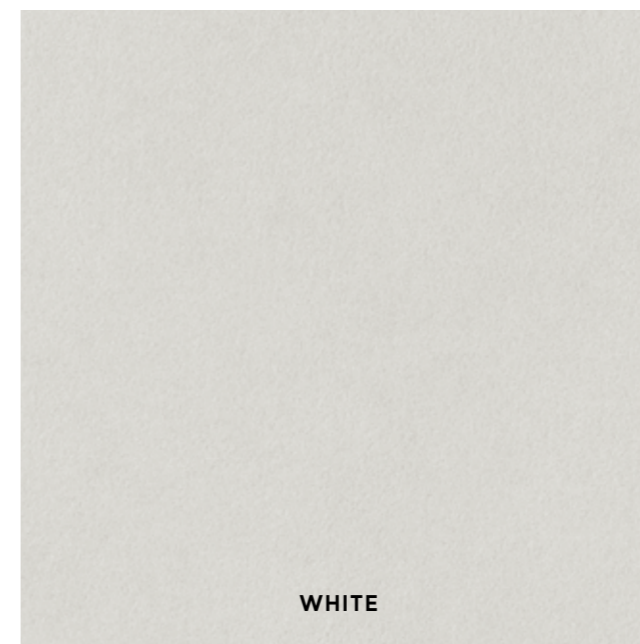

WHITE



GREY



CLAY

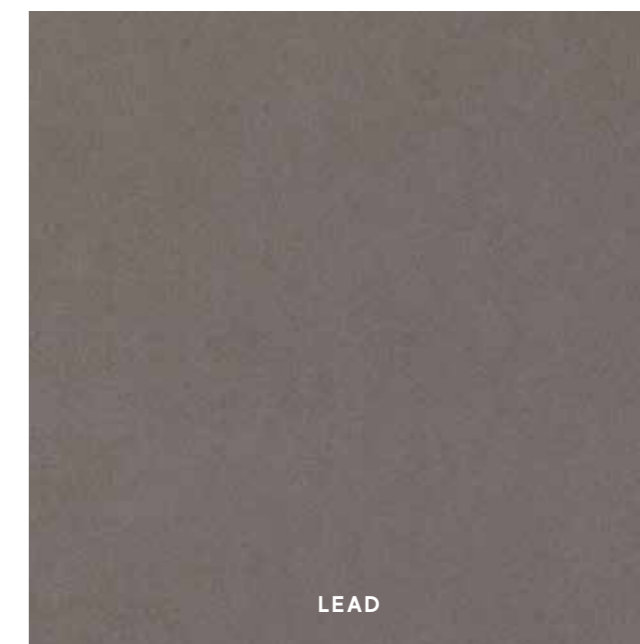

LEAD



DOVE



**V1
UNIFORM
APPEARANCE**

White,
Clay,
Grey,
Dove,
Lead

Arkshade Porcelain Tiles / Gres Porcellanato

DECOR RANGE / GAMMA DECORI



AUID Arkshade White Mosaico Prisma 36x36 - 14¹/₈"x14¹/₈"
 AUIE Arkshade Clay Mosaico Prisma 36x36 - 14¹/₈"x14¹/₈"
 AUIF Arkshade Dove Mosaico Prisma 36x36 - 14¹/₈"x14¹/₈"
 AUIG Arkshade Grey Mosaico Prisma 36x36 - 14¹/₈"x14¹/₈"
 AUIH Arkshade Lead Mosaico Prisma 36x36 - 14¹/₈"x14¹/₈"



AUHA Arkshade White Mosaico 30x30 - 11³/₄"x11³/₄"
 AUHB Arkshade Clay Mosaico 30x30 - 11³/₄"x11³/₄"
 AUHC Arkshade Dove Mosaico 30x30 - 11³/₄"x11³/₄"
 AUHD Arkshade Grey Mosaico 30x30 - 11³/₄"x11³/₄"
 AUHE Arkshade Lead Mosaico 30x30 - 11³/₄"x11³/₄"



atlas concorde



AUII Arkshade White Mosaico Art 3D * 35,4x35,4 - 14"x14"
 AUIJ Arkshade Clay Mosaico Art 3D * 35,4x35,4 - 14"x14"
 AUIK Arkshade Dove Mosaico Art 3D * 35,4x35,4 - 14"x14"
 AUIL Arkshade Grey Mosaico Art 3D * 35,4x35,4 - 14"x14"
 AUIM Arkshade Lead Mosaico Art 3D * 35,4x35,4 - 14"x14"



AUH0 Arkshade White Mosaico Linea 3D * 30x60 - 11³/₄"x23⁵/₈"
 AUH1 Arkshade Clay Mosaico Linea 3D * 30x60 - 11³/₄"x23⁵/₈"
 AUH2 Arkshade Dove Mosaico Linea 3D * 30x60 - 11³/₄"x23⁵/₈"



AUH3 Arkshade Grey Mosaico Linea 3D * 30x60 - 11³/₄"x23⁵/₈"
 AUH4 Arkshade Lead Mosaico Linea 3D * 30x60 - 11³/₄"x23⁵/₈"

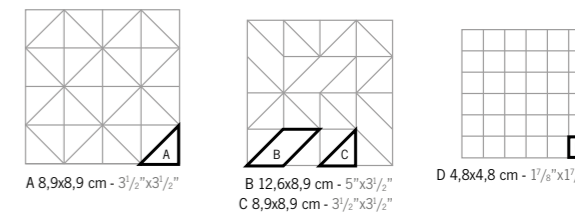

* MULTI-THICKNESS MOSAIC, CLOSE JOINT INSTALLATION WITHOUT GROUTING.
 MOSAICO MULTISPESORE, POSA SENZA STUCCATURA A GIUNTO UNITO.
 Mosaïque multi-épaisseur, pose sans mortier avec joint nul.
 Mosaik mit verschieden Stärken, fugenlose Verlegung ohne Mörtel.
 Mosaico multiespesor, colocación sin mástique y sin juntas.
 Мозаика разной толщины; укладка встык без затирки швов.

THE DECORATION CAN ONLY BE LAID ON THE WALL | IL DECORO SI PUÒ POSARE SOLO A RIVESTIMENTO
 Décor uniquement mural | Das Dekor kann nur an der Wand verlegt werden | La decoración se puede colocar únicamente en paredes | Декор может быть уложен только на стену.

Arkshade Porcelain Tiles / Gres Porcellanato

DECOR RANGE / GAMMA DECORI



AUH5 Arkshade White Brick
30x60 - 11³/₄"x23⁵/₈"



AUH8 Arkshade Grey Brick
30x60 - 11³/₄"x23⁵/₈"



AUH6 Arkshade Clay Brick
30x60 - 11³/₄"x23⁵/₈"



AUH9 Arkshade Lead Brick
30x60 - 11³/₄"x23⁵/₈"



AUH7 Arkshade Dove Brick
30x60 - 11³/₄"x23⁵/₈"

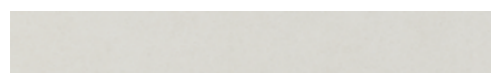
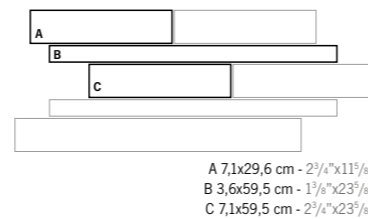

AUG5 Arkshade White Listello 8x60
8x60 - 3¹/₈"x23⁵/₈"

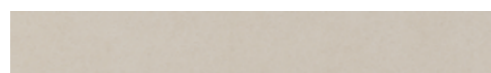

AUG6 Arkshade Clay Listello 8x60
8x60 - 3¹/₈"x23⁵/₈"



AUG7 Arkshade Dove Listello 8x60
8x60 - 3¹/₈"x23⁵/₈"



AUG8 Arkshade Grey Listello 8x60
8x60 - 3¹/₈"x23⁵/₈"



AUG9 Arkshade Lead Listello 8x60
8x60 - 3¹/₈"x23⁵/₈"



TRIM TILES / PEZZI SPECIALI

p. 424

		Battiscopa 7,2x60 2 ⁷ / ₈ "x23 ⁵ / ₈ "	Battiscopa Lappato 7,2x60 2 ⁷ / ₈ "x23 ⁵ / ₈ "	Gradino * 30x60 11 ³ / ₄ "x23 ⁵ / ₈ "	Scalino * 33x150 13"x59"	Scalino * 33x90 13"x35 ³ / ₈ "	Scalino * 33x75 13"x29 ¹ / ₂ "	Scalino * 33x60 13"x23 ⁵ / ₈ "	Scalino Angolare * 33x33 13"x13"	Battiscopa Sag. Scala 7,2x30 - 2 ⁷ / ₈ "x11 ³ / ₄ "		Elemento L Grip * 15x60 H. 4 5 ⁷ / ₈ "x23 ⁵ / ₈ " H. 1 ⁵ / ₈ "
										DX *	SX *	
White	AUIU	AUIP	AUI9	A8KA	AUJJ	AUJO	AUJE	AUJT	AUIZ	AUI4	A8J5	
Clay	AUIV	AUIQ	AUJA	A8KB	AUJK	AUJP	AUJF	AUJU	AUIØ	AUI5	A8J6	
Dove	AUIW	AUIR	AUJB	A8KC	AUJL	AUJQ	AUJG	AUJV	AUI1	AUI6	A8J7	
Grey	AUIX	AUIS	AUJC	A8KD	AUJM	AUJR	AUJH	AUJW	AUI2	AUI7	A8J8	
Lead	AUIY	AUIT	AUJD	A8KE	AUJN	AUJS	AUJI	AUJX	AUI3	AUI8	A8J9	

* THESE PARTS ARE SUPPLIED TO ORDER . I PEZZI SONO DISPONIBILI SU ORDINAZIONE ! Les pièces sont disponibles sur commande ! Die Teile sind auf Bestellung lieferbar ! Las piezas se hacen por encargo ! Изготавливаются на заказ

UPEC p. 571





Arkshade Wall Tiles / Rivestimento

WALL TILES p. 446

MATTE SURFACE / SUPERFICIE MATT

3D WALL TILES / RIVESTIMENTO 3D

± 8,5 mm

- 40x80 cm** 15⁹/₁₆"x31¹/₂"
 8DSO Solid White Matt
 8AKL Arkshade Light Clay 40X80
 8AKV Arkshade Light Dove 40X80
 8AKE Arkshade Deep Grey 40X80
 8AKA Arkshade Cream 40X80
 8AKP Arkshade Taupe 40X80
 8AKF Arkshade Sage 40X80
 8AKH Arkshade Sky 40X80
 8AKU Arkshade Blue 40X80
 8AKN Arkshade Gemstone 40X80
 8AKW Arkshade Yellow 40X80
 8AKD Arkshade Red 40X80

± 10 mm

- 40x80 cm** 15⁹/₁₆"x31¹/₂"
 8ASC Arkshade 3D Stars Light Clay 40X80
 8ASD Arkshade 3D Stars Light Dove 40X80
 8ASB Arkshade 3D Stars Blue 40X80
 8ASY Arkshade 3D Stars Yellow 40X80

TRIM TILES / PEZZI SPECIALI

LD8W Spigolo 8,5mm White Matt 0,8x20 cm - 3 ¹ / ₈ "x7 ⁷ / ₈ "	A8DW Spigolo 8,5mm White Matt A.E. 0,8x0,8 cm - 3 ¹ / ₈ "x3 ¹ / ₈ "	LAKS Arkshade Sage Spigolo 0,8x20 cm - 3 ¹ / ₈ "x7 ⁷ / ₈ "	AAKS Arkshade Sage Spigolo A.E. 0,8x0,8 cm - 3 ¹ / ₈ "x3 ¹ / ₈ "
LAKC Arkshade Light Clay Spigolo 0,8x20 cm - 3 ¹ / ₈ "x7 ⁷ / ₈ "	AAKC Arkshade Light Clay Spigolo A.E. 0,8x0,8 cm - 3 ¹ / ₈ "x3 ¹ / ₈ "	LAKO Arkshade Gemstone Spigolo 0,8x20 cm - 3 ¹ / ₈ "x7 ⁷ / ₈ "	AAKM Arkshade Gemstone Spigolo A.E. 0,8x0,8 cm - 3 ¹ / ₈ "x3 ¹ / ₈ "
LAKD Arkshade Light Dove Spigolo 0,8x20 cm - 3 ¹ / ₈ "x7 ⁷ / ₈ "	AAKD Arkshade Light Dove Spigolo A.E. 0,8x0,8 cm - 3 ¹ / ₈ "x3 ¹ / ₈ "	LAKK Arkshade Sky Spigolo 0,8x20 cm - 3 ¹ / ₈ "x7 ⁷ / ₈ "	AAKK Arkshade Sky Spigolo A.E. 0,8x0,8 cm - 3 ¹ / ₈ "x3 ¹ / ₈ "
LAKG Arkshade Deep Grey Spigolo 0,8x20 cm - 3 ¹ / ₈ "x7 ⁷ / ₈ "	AAKF Arkshade Deep Grey Spigolo A.E. 0,8x0,8 cm - 3 ¹ / ₈ "x3 ¹ / ₈ "	LAKB Arkshade Blue Spigolo 0,8x20 cm - 3 ¹ / ₈ "x7 ⁷ / ₈ "	AAKB Arkshade Blue Spigolo A.E. 0,8x0,8 cm - 3 ¹ / ₈ "x3 ¹ / ₈ "
LAKE Arkshade Cream Spigolo 0,8x20 cm - 3 ¹ / ₈ "x7 ⁷ / ₈ "	AAKE Arkshade Cream Spigolo A.E. 0,8x0,8 cm - 3 ¹ / ₈ "x3 ¹ / ₈ "	LAKR Arkshade Red Spigolo 0,8x20 cm - 3 ¹ / ₈ "x7 ⁷ / ₈ "	AAKR Arkshade Red Spigolo A.E. 0,8x0,8 cm - 3 ¹ / ₈ "x3 ¹ / ₈ "
LAKT Arkshade Taupe Spigolo 0,8x20 cm - 3 ¹ / ₈ "x7 ⁷ / ₈ "	AAKT Arkshade Taupe Spigolo A.E. 0,8x0,8 cm - 3 ¹ / ₈ "x3 ¹ / ₈ "	LAKY Arkshade Yellow Spigolo 0,8x20 cm - 3 ¹ / ₈ "x7 ⁷ / ₈ "	AAKY Arkshade Yellow Spigolo A.E. 0,8x0,8 cm - 3 ¹ / ₈ "x3 ¹ / ₈ "

L1AC Arkshade Light Clay Spigolo 10mm 0,8x20 cm - 3 ¹ / ₈ "x7 ⁷ / ₈ "	L1AD Arkshade Light Dove Spigolo 10mm 0,8x20 cm - 3 ¹ / ₈ "x7 ⁷ / ₈ "	L1AB Arkshade Blue Spigolo 10mm 0,8x20 cm - 3 ¹ / ₈ "x7 ⁷ / ₈ "	L1AY Arkshade Yellow Spigolo 10mm 0,8x20 cm - 3 ¹ / ₈ "x7 ⁷ / ₈ "
--	--	--	--

* THESE PARTS ARE SUPPLIED TO ORDER . I PEZZI SONO DISPONIBILI SU ORDINAZIONE
 Les pièces sont disponibles sur commande | Die Teile sind auf Bestellung lieferbar | Las piezas se hacen por encargo | Изготавливаются на заказ

The 10 mm edge matches three-dimensional wall tiles having a 10-11 mm thickness. / Lo spigolo 10 mm si abbina a rivestimenti tridimensionali di spessore 10-11 mm. / Le bord 10 mm s'adapte aux revêtements tridimensionnels épaisseur 10-11 mm. / Die 10 mm Kante ist mit dreidimensionalen Wandfliesen mit einer Dicke von 10-11 mm kombinierbar. / La arista de 10 mm se combina con revestimientos tridimensionales de 10 -11 mm de grosor. / Угловой элемент 10 мм сочетается с трехмерной настенной плиткой толщиной 10-11 мм.

DECORATIVE RANGE / GAMMA DECORATIVA

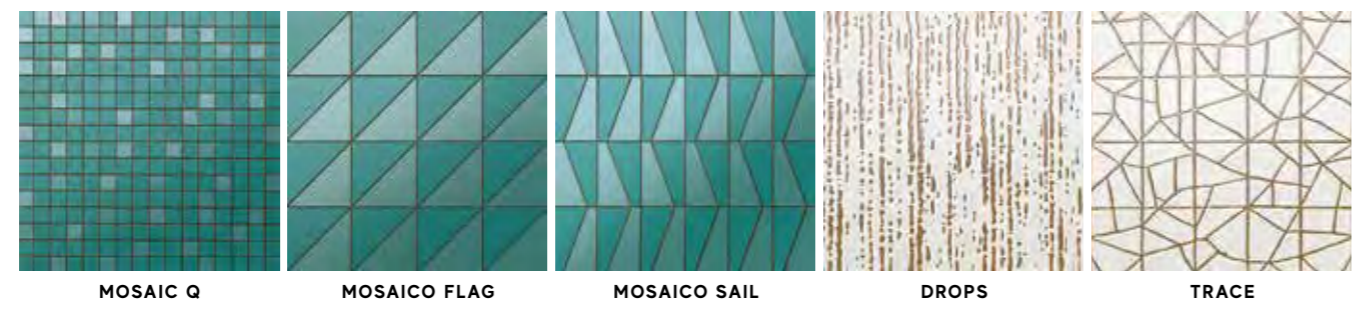

MOSAIC Q MOSAICO FLAG MOSAICO SAIL DROPS TRACE

MATTE SURFACE | SUPERFICIE MATT | Surface Mat | Matt oberfläche | Superficie Mate | Матовая поверхность



V1 UNIFORM APPEARANCE
 Solid White, Cream, Taupe, Sage, Sky, Gemstone, Deep Grey, Red, Light Clay / 3D Stars Light Clay, Light Dove / 3D Stars Light Dove, Yellow / 3D Stars Yellow, Blue / 3D Stars Blue



atlas concorde

BOOST

PORCELAIN&WALL TILES

Porcelain Tiles / Gres Porcellanato

COLOURED BODY PORCELAIN TILES - RECTIFIED MONOCALIBER
GRES PORCELLANATO COLORATO IN MASSA - RETTIFICATO MONOCALIBRO

LARGE SIZES p. 366



Sizes	Thickness	Surface finish
162x324 cm - 63 ³ / ₄ "x127 ¹ / ₂ " * NON RECTIFIED - NON RETTIFICATO	± 6 - 12 mm	Matte
160x320 cm - 63"x126"	± 6 mm	Matte R9 A
160x160 cm - 63"x63"	± 6 mm	Matte R9 A
120x278 cm - 47 ¹ / ₄ "x109 ¹ / ₂ "	± 6 mm	Matte R9 A
120x240 cm - 47 ¹ / ₄ "x94 ¹ / ₂ "	± 9 mm	Matte R10 A+B
120x120 cm - 47 ¹ / ₄ "x47 ¹ / ₄ "	± 6 mm ± 9 mm	Matte R9 A Matte R10 A+B
75x150 cm - 29 ¹ / ₂ "x59"	± 9 mm	Matte R10 A+B
60x120 cm - 23 ⁵ / ₈ "x47 ¹ / ₄ "	± 9 mm	Matte R10 A+B
75x75 cm - 29 ¹ / ₂ "x29 ¹ / ₂ "	± 9 mm	Matte R10 A+B
37,5x75 cm - 14 ³ / ₄ "x29 ¹ / ₂ "	± 9 mm	Matte R10 A+B
60x60 cm - 23 ⁵ / ₈ "x23 ⁵ / ₈ "	± 9 mm	Matte R10 A+B
30x60 cm - 11 ³ / ₄ "x23 ⁵ / ₈ "	± 9 mm	Matte R10 A+B

Outdoor Paving and Wet Areas

OUTDOOR PAVING p. 408

Sizes	Thickness	Surface finish
120x120 cm - 47 ¹ / ₄ "x47 ¹ / ₄ "	± 9 mm	Grip R11 A+B+C
120x240 cm - 47 ¹ / ₄ "x94 ¹ / ₂ "	± 20 mm	Textured R11 A+B+C
120x120 cm - 47 ¹ / ₄ "x47 ¹ / ₄ "	± 20 mm	Textured R11 A+B+C
60x120 cm - 23 ⁵ / ₈ "x47 ¹ / ₄ "	± 20 mm	Textured R11 A+B+C
90x90 cm - 35 ³ / ₈ "x35 ³ / ₈ "	± 20 mm	Textured R11 A+B+C

Wall Tiles / Rivestimento p. 466

WHITEBODY WALL TILES - RECTIFIED MONOCALIBER
RIVESTIMENTI IN PASTA BIANCA - RETTIFICATO MONOCALIBRO



Sizes	Thickness	Surface finish
40x80 cm - 15 ³ / ₄ "x31 ¹ / ₂ "	± 8,5 mm	Matte

3D Wall Tiles

Sizes	Thickness	Surface finish
40x80 cm - 15 ³ / ₄ "x31 ¹ / ₂ "	± 10 mm	Matte



Boost Porcelain Tiles / Gres Porcellanato

MATTE SURFACE / SUPERFICIE MATT

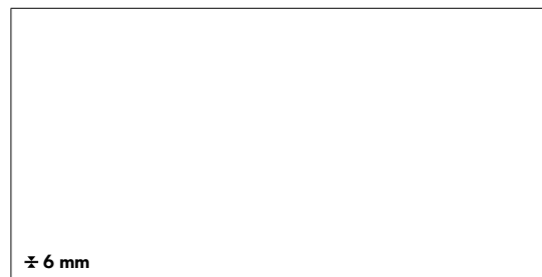

160x320 cm 63"x126"
A05Z Boost White 160x320RT
A050 Boost Smoke 160x320RT

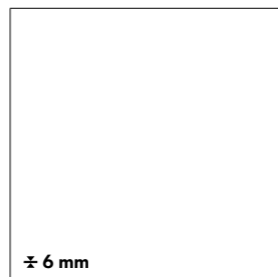

160x160 cm 63"x63"
A0DE Boost White 160x160RT
A0DF Boost Smoke 160x160RT



MATTE / MATT
162x324 cm 63³/₄"x127¹/₂"
> **NON RECTIFIED / NON RETTIFICATO**
AN1L Boost White Matt ± 6 mm
AN1M Boost White Matt ± 6 mm ST *
AN1N Boost Smoke Matt ± 6 mm
AN1O Boost Smoke Matt ± 6 mm ST *
ANVW Boost White Matt ± 12 mm
ANVX Boost White Matt ± 12 mm ST *
ANVY Boost Smoke Matt ± 12 mm
ANVO Boost Smoke Matt ± 12 mm ST *
A2XV Boost Smoke Matt ± 20 mm



120x278 cm 47¹/₂"x109¹/₂"
A0BD Boost White 120x278
A0BE Boost Pearl 120x278
A0BF Boost Grey 120x278
A0BG Boost Smoke 120x278
A0QB Boost Tarmac 120x278

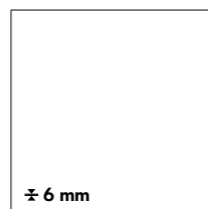

120x120 cm 47¹/₂"x47¹/₂"
A2TK Boost White 120x120 6mm
A2TM Boost Pearl 120x120 6mm
A2TN Boost Grey 120x120 6mm
A2TO Boost Smoke 120x120 6mm
A2TP Boost Tarmac 120x120 6mm



120x240 cm 47¹/₂"x94¹/₂"
AMGD Boost White 120x240
AMGE Boost Pearl 120x240
AMGF Boost Grey 120x240
AMGG Boost Smoke 120x240
AMGH Boost Tarmac 120x240

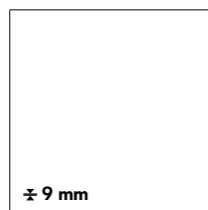

120x120 cm 47¹/₂"x47¹/₂"
AMGI Boost White 120x120
AMGJ Boost Pearl 120x120
AMGK Boost Grey 120x120
AMGL Boost Smoke 120x120
AMGM Boost Tarmac 120x120



60x120 cm 23³/₈"x47¹/₂"
A0MO Boost White 60x120
A0MP Boost Pearl 60x120
A0MQ Boost Grey 60x120
A0MR Boost Smoke 60x120
A0MS Boost Tarmac 60x120



75x150 cm 29¹/₂"x59"
AME4 Boost White 75x150
AME5 Boost Pearl 75x150
AMGS Boost Grey 75x150
AMGT Boost Smoke 75x150
AMGU Boost Tarmac 75x150

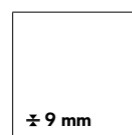

75x75 cm 29¹/₂"x29¹/₂"
AME6 Boost White 75x75
AME7 Boost Pearl 75x75
AMGV Boost Grey 75x75
AMGW Boost Smoke 75x75
AMGX Boost Tarmac 75x75

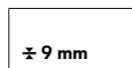

37,5x75 cm 14³/₈"x29¹/₂"
A0N8 Boost White 37,5x75
A0N9 Boost Pearl 37,5x75
A0OA Boost Grey 37,5x75
A0OB Boost Smoke 37,5x75
A0OC Boost Tarmac 37,5x75

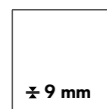

60x60 cm 23³/₈"x23³/₈"
AMH3 Boost White 60x60
AMH4 Boost Pearl 60x60
AMH5 Boost Grey 60x60
AMH6 Boost Smoke 60x60
AMH7 Boost Tarmac 60x60

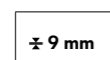

30x60 cm 11³/₈"x23³/₈"
AMH8 Boost White 30x60
AMH9 Boost Pearl 30x60
AMIA Boost Grey 30x60
AMIC Boost Smoke 30x60
AMID Boost Tarmac 30x60

MATTE SURFACE | SUPERFICIE MATT | Surface Mat | Matt oberfläche | Superficie Mate | Матовая поверхность

* WITH FIBERGLASS MESH | VERSIONE STUOIATA | Version à nattes | Ausführung mit Glasfasermatte | Version con malla | С упрочнением из стекловолокон
NON RECTIFIED | NON RETTIFICATO | Non rectifié | Nicht rektifiziert | No rectificada | Неретифицированные



WHITE



PEARL



GREY

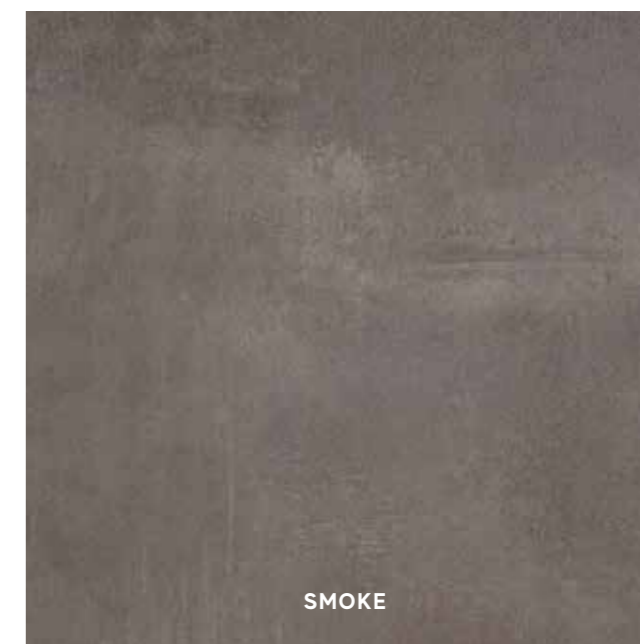

SMOKE

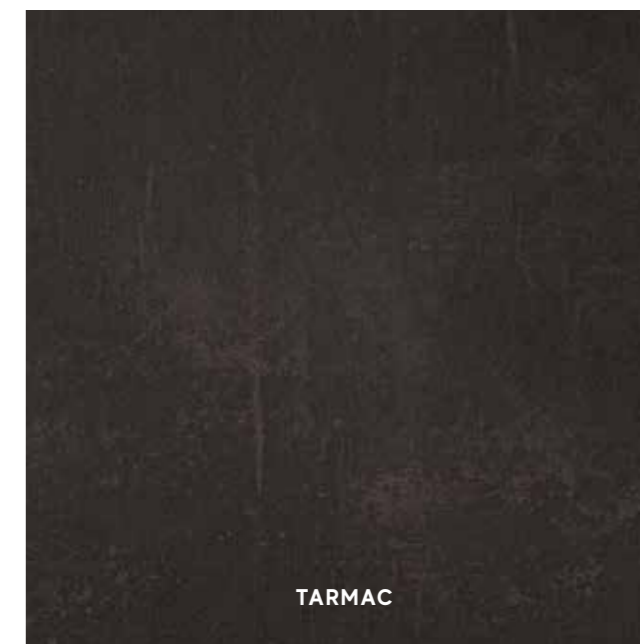

TARMAC



V3
MODERATE
VARIATION
White, Pearl,
Grey, Smoke,
Tarmac



Boost Porcelain Tiles / Gres Porcellanato

GRIP SURFACE / SUPERFICIE GRIP

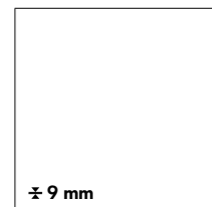

120x120 cm 47¹/₄"x47¹/₄"
AMGN Boost White 120x120 Grip
AMGO Boost Pearl 120x120 Grip
AMGP Boost Grey 120x120 Grip
AMGQ Boost Smoke 120x120 Grip
AMGR Boost Tarmac 120x120 Grip



OUTDOOR PAVING ± 20 mm / PAVIMENTI DA ESTERNO ± 20 mm

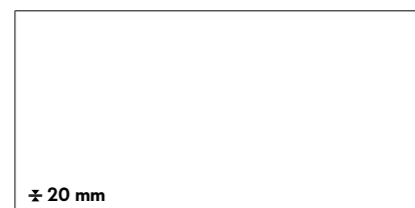

120x240 cm 47¹/₄"x94¹/₂"
A2R0 Boost White 120x240 20mm
A2R9 Boost Grey 120x240 20mm

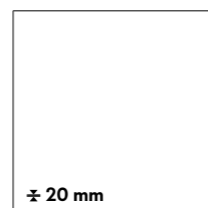

120x120 cm 47¹/₄"x47¹/₄"
AMG3 Boost White 120x120 Lastra 20 mm
AMG5 Boost Grey 120x120 Lastra 20 mm
AMG6 Boost Smoke 120x120 Lastra 20 mm
AMG7 Boost Tarmac 120x120 Lastra 20 mm



60x120 cm 23³/₈"x47¹/₄"
AL80 Boost White 60x120 Lastra 20 mm
AL81 Boost Grey 60x120 Lastra 20 mm
AL82 Boost Smoke 60x120 Lastra 20 mm
AL83 Boost Tarmac 60x120 Lastra 20 mm

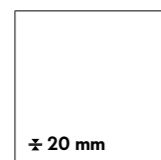

90x90 cm 35³/₈"x35³/₈"
AMB0 Boost White 90x90 Lastra 20 mm
AMB1 Boost Grey 90x90 Lastra 20 mm
AMB2 Boost Smoke 90x90 Lastra 20 mm
AMCK Boost Tarmac 90x90 Lastra 20 mm

GRIP / OUTDOOR PAVING ± 20 mm



WHITE



PEARL



GREY

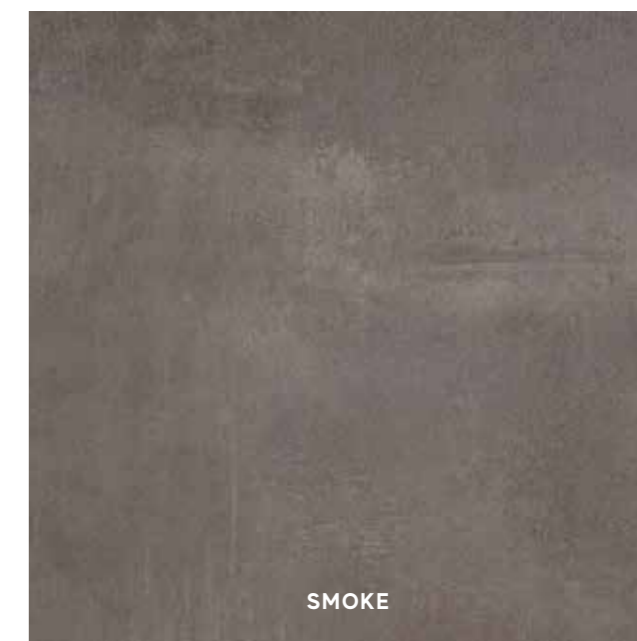

SMOKE

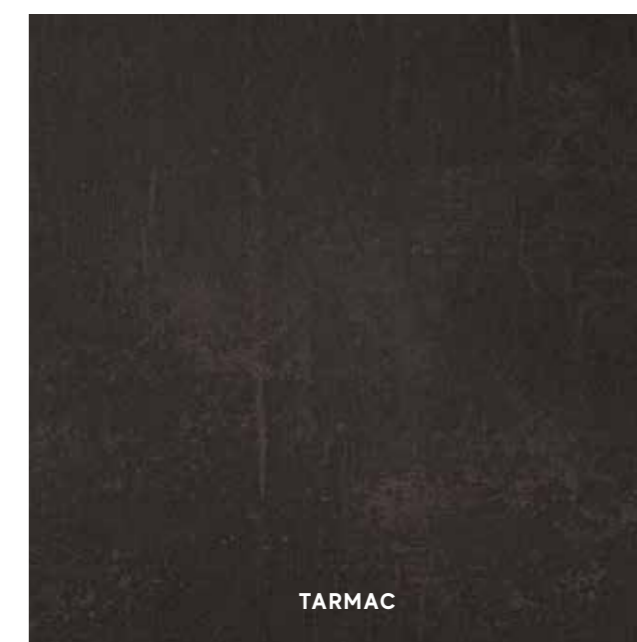

TARMAC



V3
MODERATE
VARIATION
White, Pearl,
Grey, Smoke,
Tarmac

Boost Porcelain Tiles / Gres Porcellanato

DECOR RANGE / GAMMA DECORI



AN6X Boost White Mosaico 30x30 - 11³/₄"x11³/₄"
 AN6Y Boost Pearl Mosaico 30x30 - 11³/₄"x11³/₄"
 AN6Z Boost Grey Mosaico 30x30 - 11³/₄"x11³/₄"
 AN61 Boost Smoke Mosaico 30x30 - 11³/₄"x11³/₄"
 AN62 Boost Tarmac Mosaico 30x30 - 11³/₄"x11³/₄"

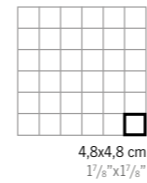

AN63 Boost White Mosaico Shapes 31x33,5 - 12¹/₄"x13³/₄"
 AN64 Boost Pearl Mosaico Shapes 31x33,5 - 12¹/₄"x13³/₄"
 AN65 Boost Grey Mosaico Shapes 31x33,5 - 12¹/₄"x13³/₄"

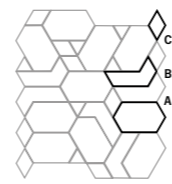

A 11,4x6,5 cm - 4¹/₂"x2¹/₂"
 B 11,4x6,5 cm - 4¹/₂"x2¹/₂"
 C 6,3x3,2 cm - 2¹/₂"x1¹/₄"



AN66 Boost Smoke Mosaico Shapes 31x33,5 - 12¹/₄"x13³/₄"
 AN67 Boost Tarmac Mosaico Shapes 31x33,5 - 12¹/₄"x13³/₄"



AN68 Boost Smoke Mosaico Hex Yellow 25x28,5 - 9⁷/₈"x11¹/₄"
 AN69 Boost Smoke Mosaico Hex Black 25x28,5 - 9⁷/₈"x11¹/₄"

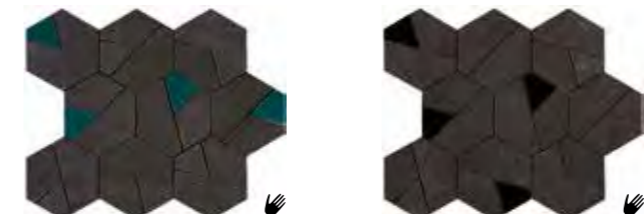

AN7A Boost Tarmac Mosaico Hex Jade 25x28,5 - 9⁷/₈"x11¹/₄"
 AN7B Boost Tarmac Mosaico Hex Black 25x28,5 - 9⁷/₈"x11¹/₄"

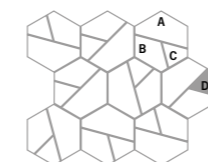

A 9,7x3,8 cm - 3⁷/₈"x1¹/₂"
 B 4,8x3,8 cm - 1⁷/₈"x1¹/₂"
 C 4,6x3,6 cm - 1⁵/₈"x1¹/₂"
 D 4,6x3,6 cm - 1⁵/₈"x1¹/₂"



TRIM TILES / PEZZI SPECIALI

p. 424

UPEC p. 571

		Battiscopa 7,2x60 2 ⁷ / ₈ "x23 ⁵ / ₈ "	Battiscopa Digitale 4,6x60 1 ³ / ₄ "x23 ⁵ / ₈ "	Gradino * 30x60 11 ³ / ₄ "x23 ⁵ / ₈ "	Scalino * 33x150 13"x59"	Scalino * 33x120 13"x47 ¹ / ₄ "	Scalino * 33x90 13"x35 ³ / ₈ "	Scalino * 33x60 13"x23 ⁵ / ₈ "	Scalino Angolare * 33x33 13"x13"	Battiscopa Sag. Scala 7,2x30 - 2 ⁷ / ₈ "x11 ³ / ₄ "	Elemento L Grip 33x120 H.4 cm 13"x47 ¹ / ₄ " H.1 ⁵ / ₈ "
		DX *	SX *								
White	AMIO	AMIU	AMJA	AMJP	AN7Ø	AN7X	AMJF	AMJK	AMIZ	AMI5	AOEI
Pearl	AMIQ	AMIV	AMJB	AMJQ	AN71	AN7W	AMJG	AMJL	AMIØ	AMI6	AOEJ
Grey	AMIR	AMIW	AMJC	AMJR	AN72	AN7Y	AMJH	AMJM	AMI1	AMI7	AOEK
Smoke	AMIS	AMIX	AMJD	AMJS	AN73	AN7Z	AMJI	AMJN	AMI3	AMI8	AOEL
Tarmac	AMIT	AMIY	AMJE	AMJT	AN74	AN7V	AMJJ	AMJO	AMI4	AMI9	AOEM

* THESE PARTS ARE SUPPLIED TO ORDER | I PEZZI SONO DISPONIBILI SU ORDINAZIONE | Les pièces sont disponibles sur commande | Die Teile sind auf Bestellung lieferbar | Las piezas se hacen por encargo | Изготавливаются на заказ

THE DECORATION CAN ONLY BE LAID ON THE WALL | IL DECORO SI PUÒ POSARE SOLO A RIVESTIMENTO
 Décor uniquement mural | Das Dekor kann nur an der Wand verlegt werden | La decoración se puede colocar únicamente en paredes | Декор может быть уложен только на стену.



Boost Wall Tiles / Rivestimento

MATTE SURFACE / SUPERFICIE MATT

± 8,5 mm

40x80 cm 15^{5/8}"x31^{1/2}"
 8B8W Boost White 40x80
 8B8P Boost Pearl 40x80
 8B8G Boost Grey 40x80
 8B8K Boost Smoke 40x80
 8B8S Boost Sage 40x80
 8B8R Boost Red 40x80

TRIM TILES / PEZZI SPECIALI

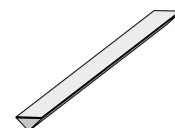

1,4x40 cm - 5/8"x15^{3/4}"
 LBBW Boost White Corner 40 •
 LBBP Boost Pearl Corner 40 •
 LBBY Boost Grey Corner 40 •
 LBBH Boost Smoke Corner 40 •
 LBBT Boost Sage Corner 40 •
 LBBQ Boost Red Corner 40 •



1,4x1,4 cm - 5/8"x5/8"
 A0AW Boost White Corner A.E. •
 A0AP Boost Pearl Corner A.E. •
 A0AG Boost Grey Corner A.E. •
 A0AK Boost Smoke Corner A.E. •
 A0AS Boost Sage Corner A.E. •
 A0AR Boost Red Corner A.E. •

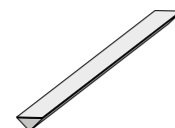

1,4x40 cm - 5/8"x15^{3/4}"
 LB3W Boost White 3D Corner 40 •
 LB3P Boost Pearl 3D Corner 40 •
 LB3G Boost Grey 3D Corner 40 •

DECORATIVE RANGE / GAMMA DECORATIVA

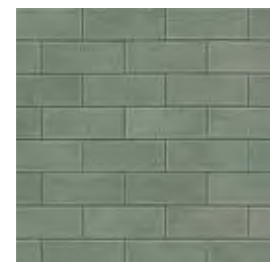

MINIBRICK



WALL TILES p. 466

3D WALL TILES / RIVESTIMENTO 3D

± 10 mm

40x80 cm 15^{5/8}"x31^{1/2}"
 8BUW Boost 3D Urban White 40x80
 8BUP Boost 3D Urban Pearl 40x80
 8BUG Boost 3D Urban Grey 40x80



SMOKE



WHITE



3D URBAN WHITE



SAGE



PEARL

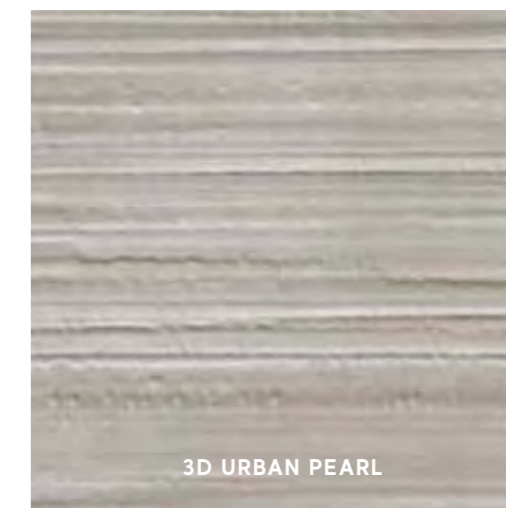

3D URBAN PEARL



RED



GREY

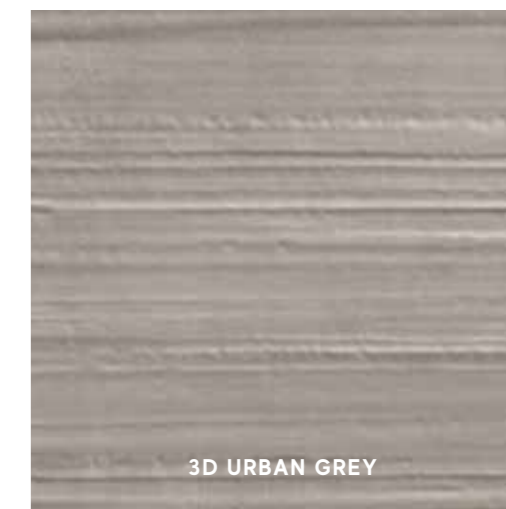

3D URBAN GREY



V2 SLIGHT VARIATION

White, 3D Urban White,
 Pearl, 3D Urban Pearl,
 Grey, 3D Urban Grey,
 Smoke,
 Sage,
 Red

* THESE PARTS ARE SUPPLIED TO ORDER . I PEZZI SONO DISPONIBILI SU ORDINAZIONE
 Les pièces sont disponibles sur commande | Die Teile sind auf Bestellung lieferbar | Las piezas se hacen por encargo | Изготавливаются на заказ
MATTE SURFACE | SUPERFICIE MATT | Surface Mat | Matt oberfläche | Superficie Mate | Матовая поверхность



atlas concorde

dwell

PORCELAIN&WALL TILES

Porcelain Tiles / Gres Porcellanato

COLOURED BODY PORCELAIN TILES - RECTIFIED MONOCALIBER
GRES PORCELLANATO COLORATO IN MASSA - RETTIFICATO MONOCALIBRO

LARGE SIZES p. 366

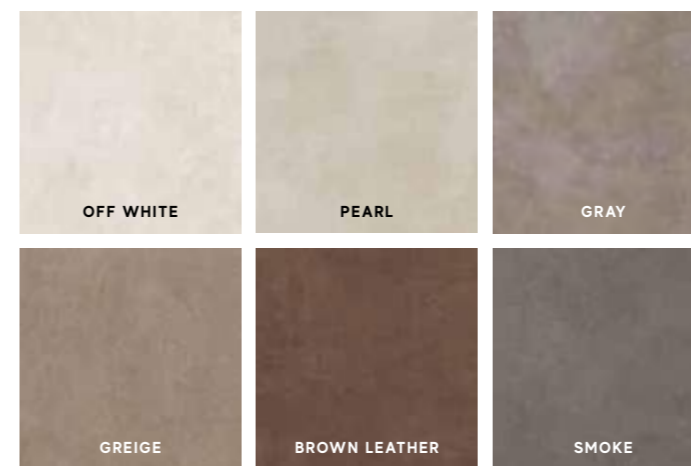

Sizes	Thickness	Surface finish
120x120 cm - 47 ¹ / ₄ "x47 ¹ / ₄ "	± 9 mm	Matte R9 A
75x150 cm - 29 ¹ / ₂ "x59"	± 9 mm	Polished Matte R9 A
75x75 cm - 29 ¹ / ₂ "x29 ¹ / ₂ "	± 9 mm	Polished Matte R9 A
45x90 cm - 17 ³ / ₄ "x35 ³ / ₈ "	± 9 mm	Polished Matte R9 A
60x60 cm - 23 ⁵ / ₈ "x23 ⁵ / ₈ "	± 9 mm	Polished Matte R9 A
30x60 cm - 11 ³ / ₄ "x23 ⁵ / ₈ "	± 9 mm	Polished Matte R9 A

Outdoor Paving and Wet Areas

OUTDOOR PAVING p. 408

Sizes	Thickness	Surface finish
90x90 cm - 35 ³ / ₈ "x35 ³ / ₈ "	± 20 mm	Textured R11 A+B+C

Wall Tiles / Rivestimento p. 474

WHITEBODY WALL TILES - RECTIFIED MONOCALIBER
RIVESTIMENTI IN PASTA BIANCA - RETTIFICATO MONOCALIBRO

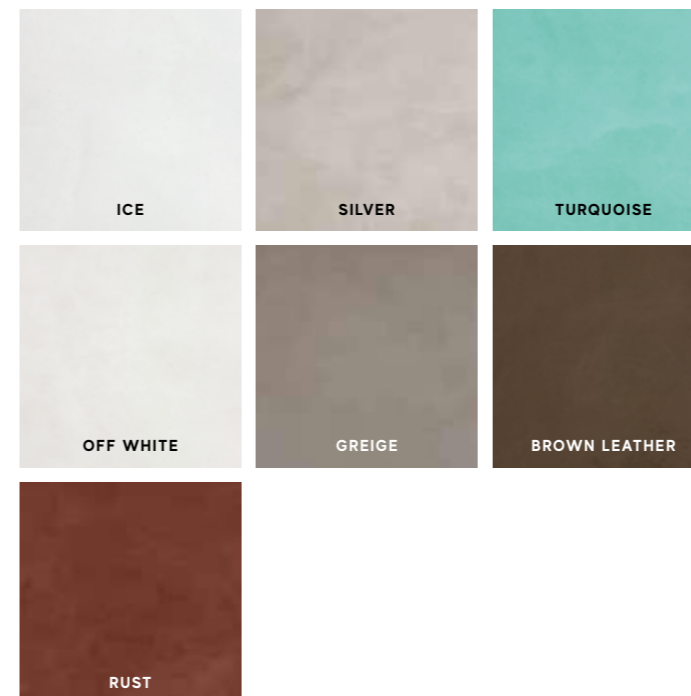

Sizes	Thickness	Surface finish
50x110 cm - 19 ⁵ / ₈ "x43 ¹ / ₄ "	± 8,5 mm	Shiny
40x80 cm - 15 ³ / ₄ "x31 ¹ / ₂ "	± 8,5 mm	Shiny



Dwell Porcelain Tiles / Gres Porcellanato

MATTE SURFACE / SUPERFICIE MATT

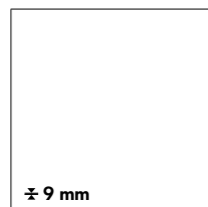

120x120 cm 47 1/4" x 47 1/4"
A1QJ Dwell Off White 120x120
A1QK Dwell Gray 120x120
A1QL Dwell Greige 120x120
A1QM Dwell Smoke 120x120

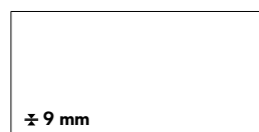

75x150 cm 29 1/2" x 59"
AW7V Dwell Off White 75x150
AW7W Dwell Pearl 75x150
AW7X Dwell Gray 75x150
AW7Y Dwell Greige 75x150
AW7Z Dwell Brown Leather 75x150
AW7Ø Dwell Smoke 75x150

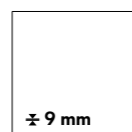

75x75 cm 29 1/2" x 29 1/2"
AW78 Dwell Off White 75x75
AW8A Dwell Pearl 75x75
AW8B Dwell Gray 75x75
AW8C Dwell Greige 75x75
AW8D Dwell Brown Leather 75x75
AW8E Dwell Smoke 75x75

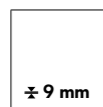

60x60 cm 23 5/8" x 23 5/8"
AW8Y Dwell Off White 60x60
AW8Z Dwell Pearl 60x60
AW8Ø Dwell Gray 60x60
AW81 Dwell Greige 60x60
AW82 Dwell Brown Leather 60x60
AW83 Dwell Smoke 60x60



30x60 cm 11 3/4" x 23 5/8"
DØ61 Dwell Off White 30x60
DØ62 Dwell Pearl 30x60
DØ63 Dwell Gray 30x60
DØ64 Dwell Greige 30x60
DØ65 Dwell Brown Leather 30x60
DØ66 Dwell Smoke 30x60

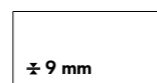

45x90 cm 17 3/4" x 35 3/8"
AW8F Dwell Off White 45x90
AW8G Dwell Pearl 45x90
AW8H Dwell Gray 45x90
AW8I Dwell Greige 45x90
AW8J Dwell Brown Leather 45x90
AW8K Dwell Smoke 45x90



OUTDOOR PAVING ± 20 mm / PAVIMENTI DA ESTERNO ± 20 mm

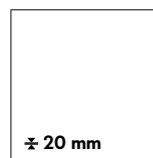

90x90 cm 35 3/8" x 35 3/8"
AL78 Dwell Off White 90x90 Lastra 20 mm
AL79 Dwell Pearl 90x90 Lastra 20 mm
AL8A Dwell Gray 90x90 Lastra 20 mm
AL8B Dwell Smoke 90x90 Lastra 20 mm

MATTE



OFF WHITE



PEARL



GREIGE

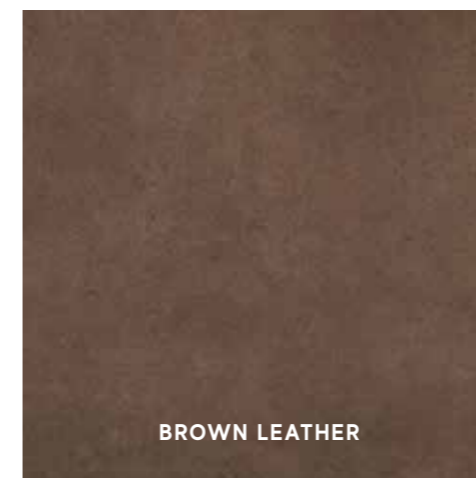

BROWN LEATHER

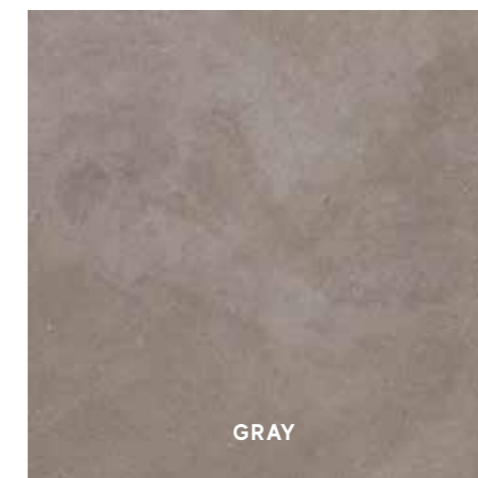

GRAY



SMOKE

OUTDOOR PAVING ± 20 mm



OFF WHITE



PEARL



GRAY

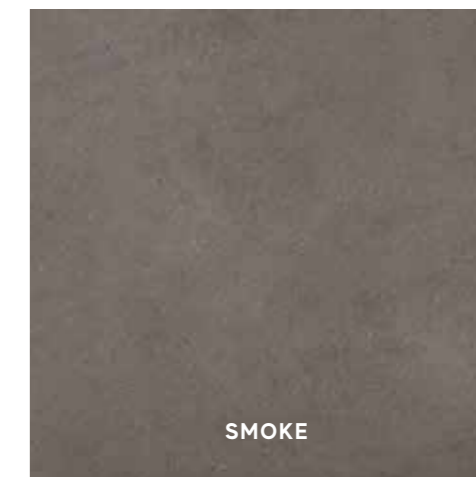

SMOKE



**V2
SLIGHT
VARIATION**

Off White,
Pearl,
Gray,
Greige,
Brown Leather,
Smoke

MATTE SURFACE | SUPERFICIE MATT | Surface Mat | Matt oberfläche | Superficie Mate | Матовая поверхность
OUTDOOR PAVING | PAVIMENTI DA ESTERNO | Sols d'extérieur | Bodenbeläge für Außenbereiche | Pavimentos para exteriores | Уличная плитка



Dwell Porcelain Tiles / Gres Porcellanato

POLISHED SURFACE / SUPERFICIE LAPPATA

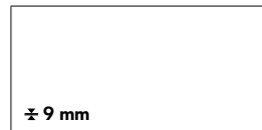

75x150 cm 29 1/2" x 59"
 AW7P Dwell Off White 75x150 Lappato
 AW7Q Dwell Pearl 75x150 Lappato
 AW7R Dwell Gray 75x150 Lappato
 AW7S Dwell Greige 75x150 Lappato
 AW7T Dwell Brown Leather 75x150 Lappato
 AW7U Dwell Smoke 75x150 Lappato

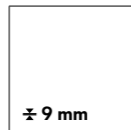

75x75 cm 29 1/2" x 29 1/2"
 AW71 Dwell Off White 75x75 Lappato
 AW72 Dwell Pearl 75x75 Lappato
 AW73 Dwell Gray 75x75 Lappato
 AW74 Dwell Greige 75x75 Lappato
 AW75 Dwell Brown Leather 75x75 Lappato
 AW77 Dwell Smoke 75x75 Lappato

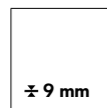

60x60 cm 23 5/8" x 23 5/8"
 AW9C Dwell Off White 60x60 Lappato
 AW9D Dwell Pearl 60x60 Lappato
 AW9E Dwell Gray 60x60 Lappato
 AW9F Dwell Greige 60x60 Lappato
 AW9G Dwell Brown Leather 60x60 Lappato
 AW9H Dwell Smoke 60x60 Lappato

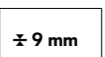

30x60 cm 11 3/4" x 23 5/8"
 D001 Dwell Off White 30x60 Lappato
 D002 Dwell Pearl 30x60 Lappato
 D003 Dwell Gray 30x60 Lappato
 D004 Dwell Greige 30x60 Lappato
 D005 Dwell Brown Leather 30x60 Lappato
 D006 Dwell Smoke 30x60 Lappato

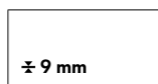

45x90 cm 17 3/4" x 35 3/8"
 AW8R Dwell Off White 45x90 Lappato
 AW8S Dwell Pearl 45x90 Lappato
 AW8T Dwell Gray 45x90 Lappato
 AW8U Dwell Greige 45x90 Lappato
 AW8V Dwell Brown Leather 45x90 Lappato
 AW8W Dwell Smoke 45x90 Lappato



The glossy polished finish is suitable for residential or low-traffic commercial floors, where no anti-slip performance is required, and for walls. The glossy polished surface finish, surprisingly brilliant and bright, features slight irregularities. The extraordinary brilliance and the easy cleaning of the surface are the result of in-depth research aimed at guaranteeing its durability over time. If the product is in direct contact with the outdoors, provide devices for absorbing moisture and dirt to prevent scratches. / La finitura Lappata lucida è indicata per pavimenti residenziali o commerciali poco sollecitati, laddove non siano richieste prestazioni antiscivolo, e per rivestimenti. La finitura lappata lucida offre una superficie sorprendentemente brillante e specchiante, con lievi irregolarità. La straordinaria lucentezza e l'elevata pulibilità della superficie sono frutto di studi approfonditi e accurate ricerche tecniche volte a garantirne la persistenza nel tempo. Se il prodotto è a diretto contatto con l'esterno, prevedere dei dispositivi di assorbimento dell'umidità e della sporcizia per prevenire la formazione di graffi.

If the product is in direct contact with the outdoors, provide devices for absorbing moisture and dirt to prevent scratches. / Se il prodotto è a diretto contatto con l'esterno, prevedere dei dispositivi di assorbimento dell'umidità e della sporcizia per prevenire la formazione di graffi.

POLISHED SURFACE | SUPERFICIE LAPPATA | Surface adouci | Geläpft oberfläche | Superficie bruñido | Полуполированный поверхность



OFF WHITE



GREIGE



PEARL



BROWN LEATHER



GRAY



SMOKE



V2
SLIGHT
VARIATION

Off White,
Pearl,
Gray,
Greige,
Brown Leather,
Smoke

Dwell Porcelain Tiles / Gres Porcellanato

DECOR RANGE / GAMMA DECORI

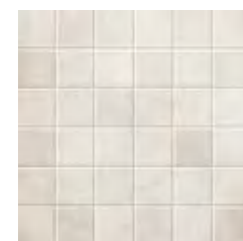

A1CX Dwell Off White Mosaico
30x30 - 11³/₄"x11³/₄"

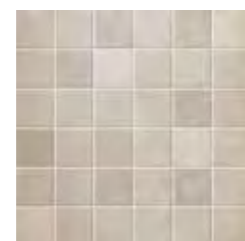

A1CY Dwell Pearl Mosaico
30x30 - 11³/₄"x11³/₄"

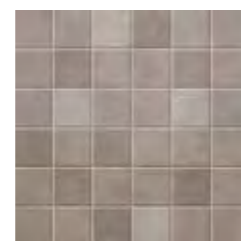

A1CZ Dwell Gray Mosaico
30x30 - 11³/₄"x11³/₄"

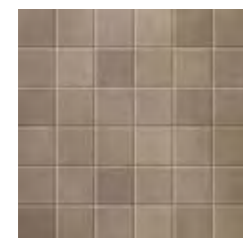
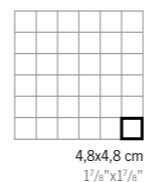

A1C0 Dwell Greige Mosaico
30x30 - 11³/₄"x11³/₄"

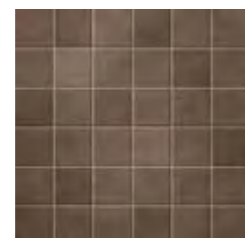

A1C1 Dwell Brown Leather Mosaico
30x30 - 11³/₄"x11³/₄"

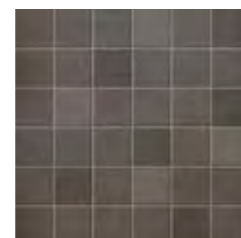

A1C2 Dwell Smoke Mosaico
30x30 - 11³/₄"x11³/₄"



A1C9 Dwell Off White Herringbone
36,2x41,2 - 14¹/₈"x16¹/₈"



A1DA Dwell Pearl Herringbone
36,2x41,2 - 14¹/₈"x16¹/₈"



A1DC Dwell Gray Herringbone
36,2x41,2 - 14¹/₈"x16¹/₈"

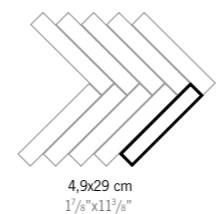

A1DD Dwell Greige Herringbone
36,2x41,2 - 14¹/₈"x16¹/₈"



A1DE Dwell Brown Leather Herringbone
36,2x41,2 - 14¹/₈"x16¹/₈"



A1DF Dwell Smoke Herringbone
36,2x41,2 - 14¹/₈"x16¹/₈"



A1YA Dwell Off White Listello
8x60 - 3¹/₈"x23³/₈"



A1YB Dwell Pearl Listello
8x60 - 3¹/₈"x23³/₈"



A1X8 Dwell Gray Listello
8x60 - 3¹/₈"x23³/₈"



A1X9 Dwell Greige Listello
8x60 - 3¹/₈"x23³/₈"



A1X7 Dwell Brown Leather Listello
8x60 - 3¹/₈"x23³/₈"



A1YC Dwell Smoke Listello
8x60 - 3¹/₈"x23³/₈"



A1DQ Dwell Off White Brick Lappato
21,7x43,6 - 8¹/₂"x17¹/₈"



A1E3 Dwell Pearl Brick Lappato
21,7x43,6 - 8¹/₂"x17¹/₈"

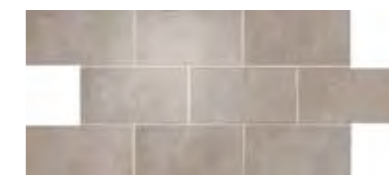

A1E4 Dwell Gray Brick Lappato
21,7x43,6 - 8¹/₂"x17¹/₈"

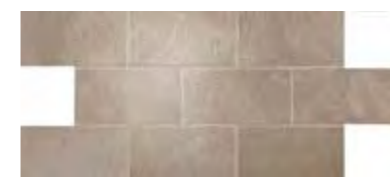
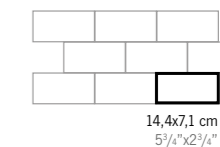

A1E5 Dwell Greige Brick Lappato
21,7x43,6 - 8¹/₂"x17¹/₈"

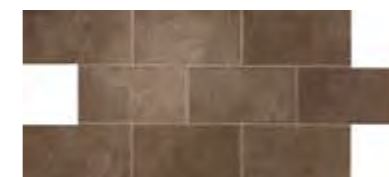

A1E6 Dwell Brown Leather Brick Lappato
21,7x43,6 - 8¹/₂"x17¹/₈"

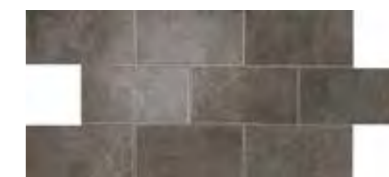

A1E7 Dwell Smoke Brick Lappato
21,7x43,6 - 8¹/₂"x17¹/₈"



A1DK Dwell Off White Chevron 3D *
30,8x35,1 - 12"x13³/₄"



A1DL Dwell Pearl Chevron 3D *
30,8x35,1 - 12"x13³/₄"



A1DM Dwell Gray Chevron 3D *
30,8x35,1 - 12"x13³/₄"

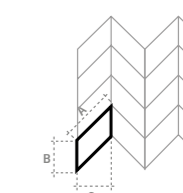

A1DN Dwell Greige Chevron 3D *
30,8x35,1 - 12"x13³/₄"



A1DO Dwell Brown Leather Chevron 3D *
30,8x35,1 - 12"x13³/₄"



A1DP Dwell Smoke Chevron 3D *
30,8x35,1 - 12"x13³/₄"

*** MULTI-THICKNESS MOSAIC, CLOSE JOINT INSTALLATION WITHOUT GROUTING.**
MOSAICO MULTISPESORE, POSA SENZA STUCCATURA A GIUNTO UNITO.
 Mosaïque multi-épaisseur, pose sans mastic avec joint nul.
 Mosaik mit verschiedenen Stärken, fugenlose Verlegung ohne Mörtel.
 Mosaico multiespesor, colocación sin mástico y sin juntas.
 Мозаика разной толщины; укладка встык без затирки швов.

TRIM TILES / PEZZI SPECIALI

p. 424

	Battiscopa		Gradino *	Scalino *	Scalino *	Scalino *	Scalino *	Scalino Angolare		Battiscopa Sag. Scala	
	7,2x60 2 ⁷ / ₈ "x23 ⁵ / ₈ "	Battiscopa Lappato 7,2x60 2 ⁷ / ₈ "x23 ⁵ / ₈ "	30x60 11 ³ / ₄ "x23 ⁵ / ₈ "	33x150 13"x59"	33x90 13"x35 ⁵ / ₈ "	33x75 13"x29 ¹ / ₂ "	33x60 13"x23 ⁵ / ₈ "	DX *	SX *	DX *	SX *
Off White	A1E8	A1FG	A1KE	AZUC	A1KK	A1KQ	A1KW	A1K8	A1K2	A1LK	A1LE
Pearl	A1E9	A1FH	A1KF	AZFF	A1KL	A1KR	A1KX	A1K9	A1K3	A1LL	A1LF
Gray	A1FC	A1FI	A1KG	AZUD	A1KM	A1KS	A1KY	A1LA	A1K4	A1LM	A1LG
Greige	A1FD	A1FJ	A1KH	AZUE	A1KN	A1KT	A1KZ	A1LB	A1K5	A1LN	A1LH
Brown Leather	A1FE	A1FK	A1KI	AZUF	A1KO	A1KU	A1K0	A1LC	A1K6	A1LO	A1LI
Smoke	A1FF	A1FL	A1KJ	AZUG	A1KP	A1KV	A1K1	A1LD	A1K7	A1LP	A1LJ

* THESE PARTS ARE SUPPLIED TO ORDER | I PEZZI SONO DISPONIBILI SU ORDINAZIONE | Les pièces sont disponibles sur commande | Die Teile sind auf Bestellung lieferbar | Las piezas se hacen por encargo | Изготавливаются на заказ

THE DECORATION CAN ONLY BE LAID ON THE WALL | IL DECORO SI PUÒ POSARE SOLO A RIVESTIMENTO
 Décor uniquement mural | Das Dekor kann nur an der Wand verlegt werden | La decoración se puede colocar únicamente en paredes | Декор может быть уложен только на стену.

UPEC p. 571



Dwell Wall Tiles / Rivestimento

SHINY SURFACE / SUPERFICIE LUCIDA

WALL TILES p. 474

± 8,5 mm

± 8,5 mm

50x110 cm 19⁵/₈"x43¹/₄"

4D1W Dwell Off White 110
4D1R Dwell Greige 110
4D1B Dwell Brown Leather 110
4D1U Dwell Rust 110
4D1I Dwell Ice 110
4D1V Dwell Silver 110
4D1T Dwell Turquoise 110

40x80 cm 15³/₄"x31¹/₂"

8DWH Dwell Off White 40x80
8DWD Dwell Greige 40x80
8DWO Dwell Brown Leather 40x80
8DWA Dwell Rust 40x80
8DWC Dwell Ice 40x80
8DWL Dwell Silver 40x80
8DWQ Dwell Turquoise 40x80

TRIM TILES / PEZZI SPECIALI

LDPI Dwell Ice Spigolo
0,8x20 cm - 3¹/₈"x7⁷/₈"

A1DI Dwell Ice Spigolo A.E.
0,8x0,8 cm - 3¹/₈"x3¹/₈"

LDPS Dwell Silver Spigolo
0,8x20 cm - 3¹/₈"x7⁷/₈"

A1DS Dwell Silver Spigolo A.E.
0,8x0,8 cm - 3¹/₈"x3¹/₈"

LDPT Dwell Turquoise Spigolo
0,8x20 cm - 3¹/₈"x7⁷/₈"

A1DT Dwell Turquoise Spigolo A.E.
0,8x0,8 cm - 3¹/₈"x3¹/₈"

LDPW Dwell Off White Spigolo
0,8x20 cm - 3¹/₈"x7⁷/₈"

A1DW Dwell Off White Spigolo A.E.
0,8x0,8 cm - 3¹/₈"x3¹/₈"

LDPR Dwell Greige Spigolo
0,8x20 cm - 3¹/₈"x7⁷/₈"

A1DG Dwell Greige Spigolo A.E.
0,8x0,8 cm - 3¹/₈"x3¹/₈"

LDPO Dwell Brown Leather Spigolo
0,8x20 cm - 3¹/₈"x7⁷/₈"

A1DB Dwell Brown Leather Spigolo A.E.
0,8x0,8 cm - 3¹/₈"x3¹/₈"

LDPU Dwell Rust Spigolo
0,8x20 cm - 3¹/₈"x7⁷/₈"

A1DR Dwell Rust Spigolo A.E.
0,8x0,8 cm - 3¹/₈"x3¹/₈"

* THESE PARTS ARE SUPPLIED TO ORDER
I PEZZI SONO DISPONIBILI SU ORDINAZIONE
Les pièces sont disponibles sur commande
Die Teile sind auf Bestellung lieferbar
Las piezas se hacen por encargo
Изготавливаются на заказ

DECORATIVE RANGE / GAMMA DECORATIVA

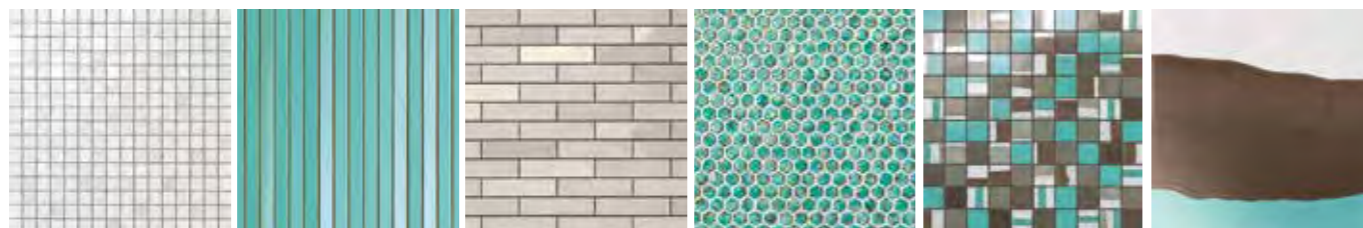

MOSAICO Q

MOSAICO L

MOSAICO BRICK

HEXAGON GOLD

MOSAICO MIX

MIX 4



ICE



SILVER

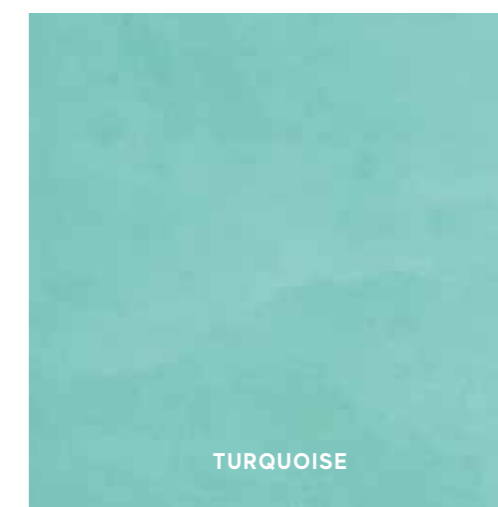

TURQUOISE



OFF WHITE



GREIGE

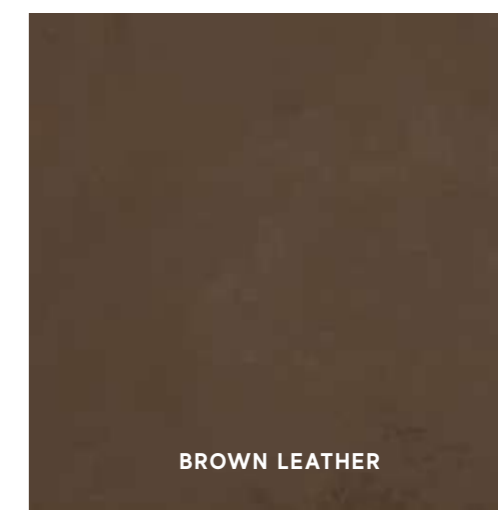

BROWN LEATHER



RUST



V2 SLIGHT VARIATION

Ice,
Silver,
Off White,
Greige,
Brown Leather,
Turquoise,
Rust



atlas concorde

evolve

PORCELAIN TILES

eWALL

WALL TILES

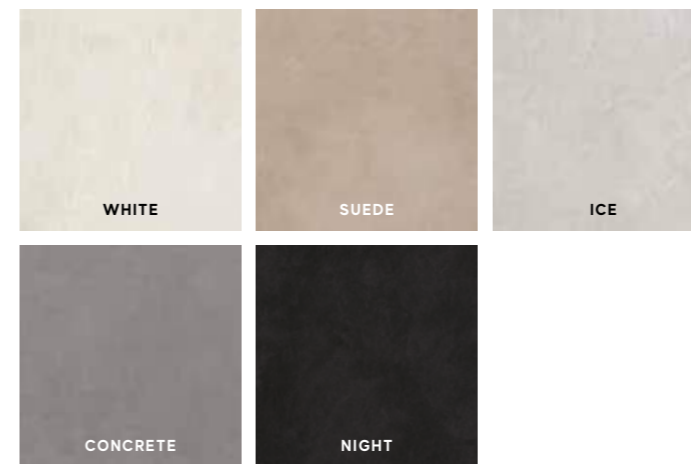

Evolve Porcelain Tiles / Gres Porcellanato

COLOURED BODY PORCELAIN TILES - RECTIFIED MONOCALIBER
GRES PORCELLANATO COLORATO IN MASSA - RETTIFICATO MONOCALIBRO

Sizes	Thickness	Surface finish
60x60 cm - 23 ⁵ / ₈ "x23 ⁵ / ₈ "	± 9 mm	Matte R9 A
30x60 cm - 11 ³ / ₄ "x23 ⁵ / ₈ "	± 9 mm	Matte R9 A



Ewall Wall Tiles / Rivestimento p. 480

WHITEBODY WALL TILES - RECTIFIED MONOCALIBER
RIVESTIMENTI IN PASTA BIANCA - RETTIFICATO MONOCALIBRO

Sizes	Thickness	Surface finish
40x80 cm - 15 ³ / ₄ "x31 ¹ / ₂ "	± 8 mm	Matte



Evolve Porcelain Tiles / Gres Porcellanato

MATTE SURFACE / SUPERFICIE MATT

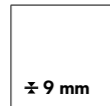

60x60 cm 23⁵/₈"x23⁵/₈"
 AJ9F Evolve Ice 60
 AJ9I Evolve Concrete 60
 AJ9W Evolve Night 60
 AJ9E Evolve White 60
 AJ9H Evolve Suede 60

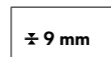

30x60 cm 11³/₄"x23⁵/₈"
 D068 Evolve Ice 30x60
 D070 Evolve Concrete 30x60
 D072 Evolve Night 30x60
 D067 Evolve White 30x60
 D069 Evolve Suede 30x60



atlas concorde

MATTE SURFACE | SUPERFICIE MATT | Surface Mat | Matt oberfläche | Superficie Mate | Матовая поверхность



WHITE

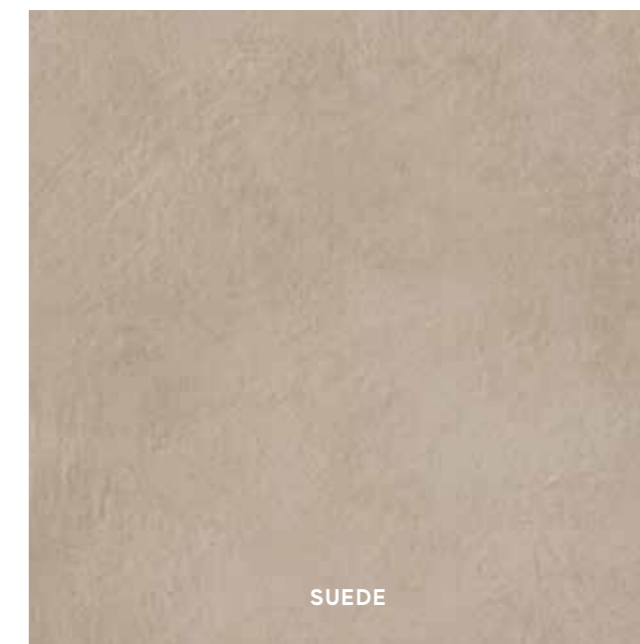

SUEDE



ICE



CONCRETE



NIGHT



V2
SLIGHT
VARIATION
 White,
 Suede,
 Ice,
 Concrete,
 Night

Evolve Porcelain Tiles / Gres Porcellanato

DECOR RANGE / GAMMA DECORI



ANFU Evolve White Mosaico
30x30 - 11³/₄"x11³/₄"



ANFW Evolve Suede Mosaico
30x30 - 11³/₄"x11³/₄"



ANFV Evolve Ice Mosaico
30x30 - 11³/₄"x11³/₄"

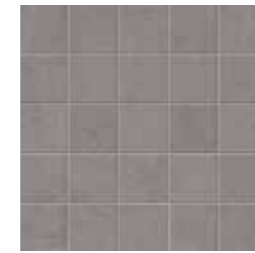

ANFX Evolve Concrete Mosaico
30x30 - 11³/₄"x11³/₄"



ANFZ Evolve Night Mosaico
30x30 - 11³/₄"x11³/₄"

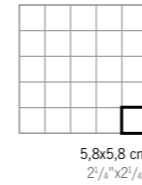

ANFM Evolve White Brick 30x60 - 11³/₄"x23⁵/₈"



ANFN Evolve Ice Brick 30x60 - 11³/₄"x23⁵/₈"



ANFO Evolve Suede Brick 30x60 - 11³/₄"x23⁵/₈"



ANFP Evolve Concrete Brick 30x60 - 11³/₄"x23⁵/₈"



ANFR Evolve Night Brick 30x60 - 11³/₄"x23⁵/₈"

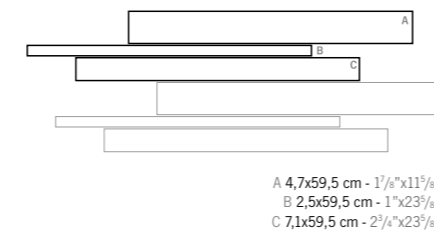

TRIM TILES / PEZZI SPECIALI

p. 424

	Battiscopa 7,2x60 2 7/8"x23 5/8"	Gradino * 30x60 11 3/4"x23 5/8"	Scalino * 33x60 - 13"x23 5/8"	Scalino Angolare * 33x33 13"x13"	Battiscopa Sag. Scala 7,2x30 - 2 7/8"x11 3/4"	
					DX *	SX *
White	ANF2	ANGU	ANG3	ANHB	ANGC	ANGK
Ice	ANF3	ANGV	ANG4	ANHC	ANGD	ANGL
Suede	ANF4	ANGW	ANG5	ANHD	ANGE	ANGM
Concrete	ANF5	ANGX	ANG8	ANHE	ANGF	ANGN
Night	ANF8	ANGØ	ANG7	ANHG	ANGH	ANGQ

* THESE PARTS ARE SUPPLIED TO ORDER | PEZZI SONO DISPONIBILI SU ORDINAZIONE | Les pièces sont disponibles sur commande | Die Teile sind auf Bestellung lieferbar | Las piezas se hacen por encargo | Изготавливаются на заказ

UPEC p. 571



atlas concorde



Ewall Wall Tiles / Rivestimento

MATTE SURFACE / SUPERFICIE MATT

WALL TILES p. 480

± 8 mm

40x80 cm 15 3/4" x 31 1/2"

- 8E4L Ewall Pure 40x80
- 8E4D Ewall Concrete 40x80
- 8E4Z Ewall White 40x80
- 8E4V Ewall Suede 40x80
- 8E4H Ewall Night 40x80
- 8E4K Ewall Moka 40x80
- 8E4G Ewall Orange 40x80
- 8E4B Ewall Amethyst 40x80
- 8E4Q Ewall Red 40x80
- 8E4F Ewall Petroleum Green 40x80

TRIM TILES / PEZZI SPECIALI

LESP Ewall Pure Spigolo
0,8x20 - 3/8"x7 1/8"

AESP Spigolo A.E.
0,8x0,8 - 3/8"x3/8"

LESM Ewall Moka Spigolo
0,8x20 - 3/8"x7 1/8"

AESM Spigolo A.E.
0,8x0,8 - 3/8"x3/8"

LESC Ewall Concrete Spigolo
0,8x20 - 3/8"x7 1/8"

AESC Spigolo A.E.
0,8x0,8 - 3/8"x3/8"

LESO Ewall Orange Spigolo
0,8x20 - 3/8"x7 1/8"

AESO Spigolo A.E.
0,8x0,8 - 3/8"x3/8"

LESW Ewall White Spigolo
0,8x20 - 3/8"x7 1/8"

AESW Spigolo A.E.
0,8x0,8 - 3/8"x3/8"

LESR Ewall Red Spigolo
0,8x20 - 3/8"x7 1/8"

AESR Spigolo A.E.
0,8x0,8 - 3/8"x3/8"

LESS Ewall Suede Spigolo
0,8x20 - 3/8"x7 1/8"

AESD Spigolo A.E.
0,8x0,8 - 3/8"x3/8"

LESA Ewall Amethyst Spigolo
0,8x20 - 3/8"x7 1/8"

AESA Spigolo A.E.
0,8x0,8 - 3/8"x3/8"

LESN Ewall Night Spigolo
0,8x20 - 3/8"x7 1/8"

AESN Spigolo A.E.
0,8x0,8 - 3/8"x3/8"

LESE Ewall Petroleum Green Spigolo
0,8x20 - 3/8"x7 1/8"

AESE Spigolo A.E.
0,8x0,8 - 3/8"x3/8"

DECORATIVE RANGE / GAMMA DECORATIVA



MINIBRICK

PLATINUM MOSAIC

STRIPES

DAMASK

GOLD DAMASK

ROSES



WHITE



SUEDE



MOKA

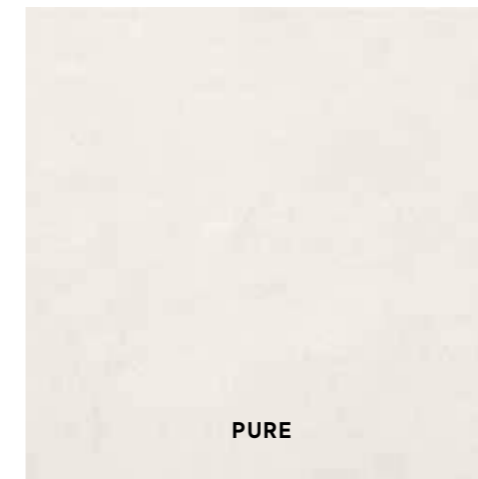

PURE



CONCRETE



NIGHT

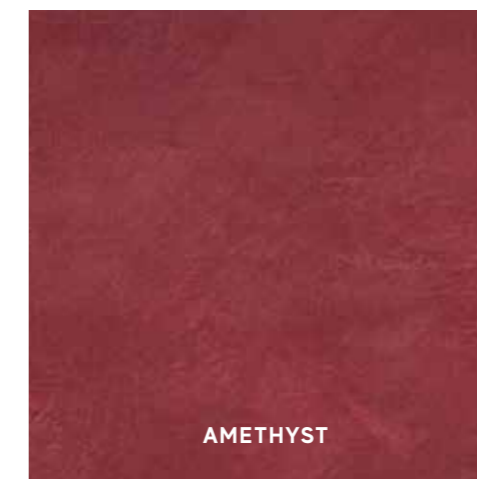

AMETHYST

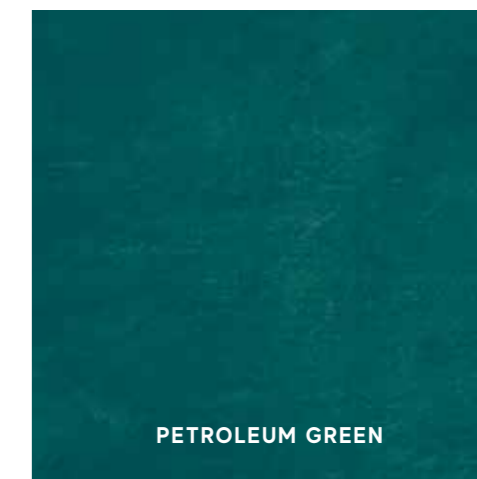

PETROLEUM GREEN

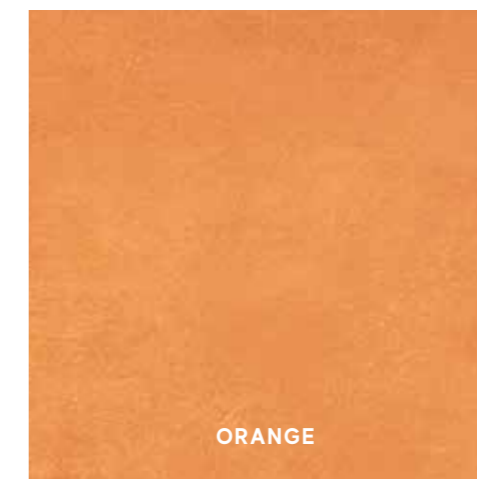

ORANGE



RED



V2 SLIGHT VARIATION

White, Suede, Pure, Moka, Concrete, Night, Amethyst, Petroleum Green, Orange, Red



atlas concorde

MARK

PORCELAIN TILES

Porcelain Tiles / Gres Porcellanato

COLOURED BODY PORCELAIN TILES - RECTIFIED MONOCALIBER
GRES PORCELLANATO COLORATO IN MASSA - RETTIFICATO MONOCALIBRO

LARGE SIZES p. 366



Sizes	Thickness	Surface finish
45x90 cm - 17 ³ / ₄ "x35 ³ / ₈ "	± 9 mm	Polished Matte R10 A
22,5x90 cm - 8 ⁷ / ₈ "x35 ³ / ₈ "	± 9 mm	Matte R10 A
60x60 cm - 23 ⁵ / ₈ "x23 ⁵ / ₈ "	± 9 mm	Polished Matte R10 A
30x60 cm - 11 ³ / ₄ "x23 ⁵ / ₈ "	± 9 mm	Polished Matte R10 A

Outdoor Paving and Wet Areas

OUTDOOR PAVING p. 408

Sizes	Thickness	Surface finish
30x60 cm - 11 ³ / ₄ "x23 ⁵ / ₈ "	± 9 mm	Textured R11 A+B+C
60x60 cm - 23 ⁵ / ₈ "x23 ⁵ / ₈ "	± 9 mm	Textured R11 A+B+C
60x60 cm - 23 ⁵ / ₈ "x23 ⁵ / ₈ "	± 20 mm	Textured R11 A+B+C



Mark Porcelain Tiles / Gres Porcellanato

MATTE SURFACE / SUPERFICIE MATT

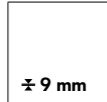

60x60 cm 23⁵/₈"x23⁵/₈"
AS6N Mark Gypsum 60 R10
AS6O Mark Pearl 60 R10
AS6P Mark Chrome 60 R10
AS6Q Mark Clay 60 R10
AS6S Mark Tobacco 60 R10
AS6T Mark Graphite 60 R10

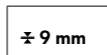

30x60 cm 11³/₈"x23⁵/₈"
D089 Mark Gypsum 30X60 R10
D090 Mark Pearl 30X60 R10
D091 Mark Chrome 30X60 R10
D092 Mark Clay 30X60 R10
D093 Mark Tobacco 30X60 R10
D094 Mark Graphite 30X60 R10



45x90 cm 17³/₈"x35³/₈"
AS6B Mark Gypsum 45x90 R10
AS6C Mark Pearl 45x90 R10
AS6D Mark Chrome 45x90 R10
AS6E Mark Clay 45x90 R10
AS6F Mark Tobacco 45x90 R10
AS6G Mark Graphite 45x90 R10

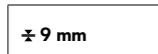

22,5x90 cm 8⁷/₈"x35³/₈"
AS6H Mark Gypsum 22,5x90 R10
AS6I Mark Pearl 22,5x90 R10
AS6J Mark Chrome 22,5x90 R10
AS6K Mark Clay 22,5x90 R10
AS6L Mark Tobacco 22,5x90 R10
AS6M Mark Graphite 22,5x90 R10



TEXTURED SURFACE / SUPERFICIE STRUTTURATA

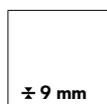

60x60 cm 23⁵/₈"x23⁵/₈"
AMUF Mark Gypsum 60 Strutturato
AMUG Mark Pearl 60 Strutturato
AMUH Mark Chrome 60 Strutturato
AMUI Mark Clay 60 Strutturato
AMUJ Mark Tobacco 60 Strutturato
AMUK Mark Graphite 60 Strutturato

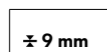

30x60 cm 11³/₈"x23⁵/₈"
D083 Mark Gypsum 30x60 Strutturato
D084 Mark Pearl 30x60 Strutturato
D085 Mark Chrome 30x60 Strutturato
D086 Mark Clay 30x60 Strutturato
D087 Mark Tobacco 30x60 Strutturato
D088 Mark Graphite 30x60 Strutturato



OUTDOOR PAVING ± 20 mm / PAVIMENTI DA ESTERNO ± 20 mm

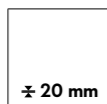

60x60 cm 23⁵/₈"x23⁵/₈"
AMTQ Mark Gypsum 60 LASTRA 20 mm
AMTR Mark Pearl 60 LASTRA 20 mm
AMTS Mark Chrome 60 LASTRA 20 mm



V3
MODERATE
VARIATION

Gypsum,
Pearl,
Chrome,
Clay,
Tobacco,
Graphite

MATTE SURFACE | SUPERFICIE MATT | Surface Mat | Matt oberfläche | Superficie Mate | Матовая поверхность
TEXTURED SURFACE | SUPERFICIE STRUTTURATA | Surface structuré | Strukturiert oberfläche | Superficie estruturado | Структурная поверхность
OUTDOOR PAVING | PAVIMENTI DA ESTERNO | Sols d'extérieur | Bodenbeläge für Außenbereiche | Pavimentos para exteriores | Уличная плитка

MATTE



GYPSUM



PEARL

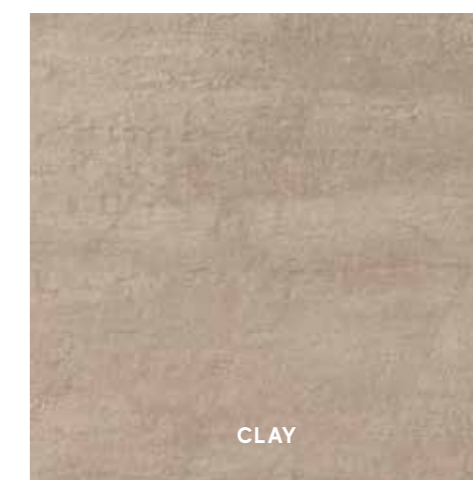

CLAY



CHROME

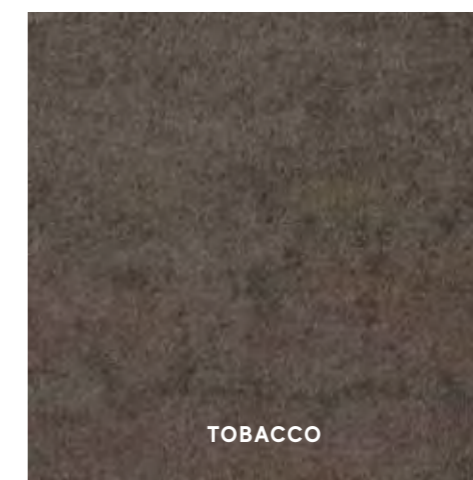

TOBACCO



GRAPHITE

TEXTURED / OUTDOOR PAVING ± 20 mm

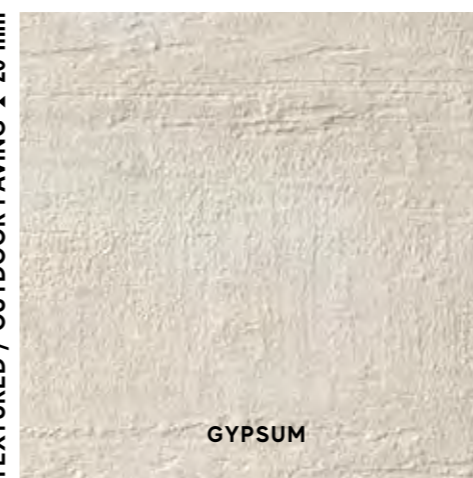

GYPSUM

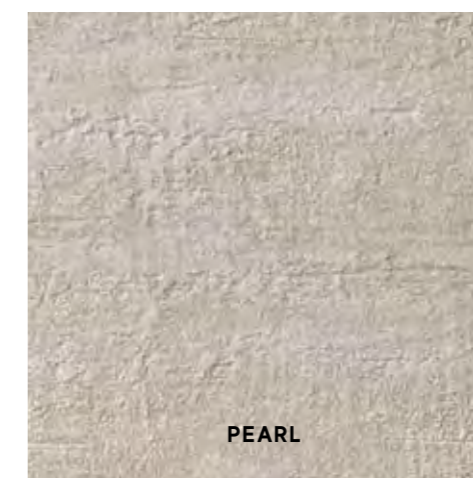

PEARL

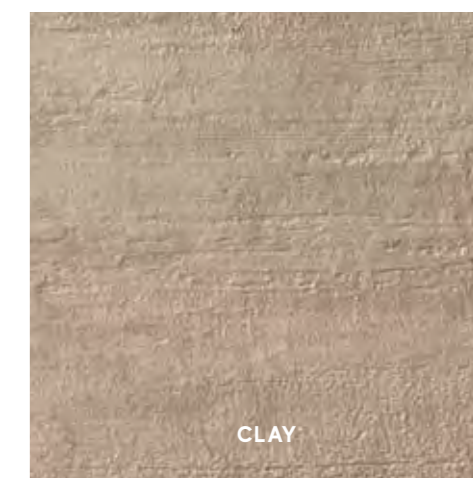

CLAY

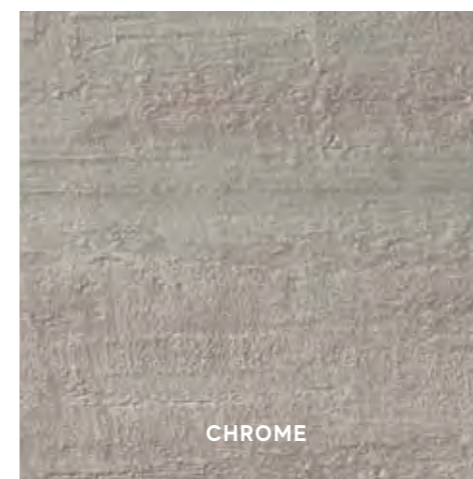

CHROME

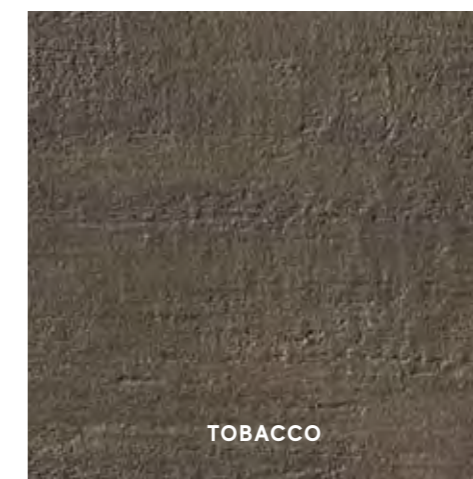

TOBACCO



GRAPHITE



Mark Porcelain Tiles / Gres Porcellanato

POLISHED SURFACE / SUPERFICIE LAPPATA

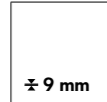

60x60 cm 23⁵/₈"x23⁵/₈"

AVWD Mark Gypsum 60 Lappato
AVWE Mark Pearl 60 Lappato
AVWF Mark Chrome 60 Lappato
AVWG Mark Clay 60 Lappato
AVWH Mark Tobacco 60 Lappato
AVWI Mark Graphite 60 Lappato

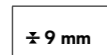

30x60 cm 11³/₈"x23⁵/₈"

D007 Mark Gypsum 30x60 Lappato
D008 Mark Pearl 30x60 Lappato
D009 Mark Chrome 30x60 Lappato
D010 Mark Clay 30x60 Lappato
D011 Mark Tobacco 30x60 Lappato
D012 Mark Graphite 30x60 Lappato

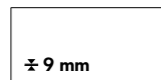

45x90 cm 17³/₈"x35³/₈"

AVWP Mark Gypsum 45x90 Lappato
AVWQ Mark Pearl 45x90 Lappato
AVWR Mark Chrome 45x90 Lappato
AVWS Mark Clay 45x90 Lappato
AVWT Mark Tobacco 45x90 Lappato
AVWU Mark Graphite 45x90 Lappato



The glossy polished finish is suitable for residential or low-traffic commercial floors, where no anti-slip performance is required, and for walls. The glossy polished surface finish, surprisingly brilliant and bright, features slight irregularities. The extraordinary brilliance and the easy cleaning of the surface are the result of in-depth research aimed at guaranteeing its durability over time. If the product is in direct contact with the outdoors, provide devices for absorbing moisture and dirt to prevent scratches. / La finitura Lappata lucida è indicata per pavimenti residenziali o commerciali poco sollecitati, laddove non siano richieste prestazioni antiscivolo, e per rivestimenti. La finitura lappata lucida offre una superficie sorprendentemente brillante e specchiante, con lievi irregolarità. La straordinaria lucentezza e l'elevata pulibilità della superficie sono frutto di studi approfonditi e accurate ricerche tecniche volte a garantirne la persistenza nel tempo. Se il prodotto è a diretto contatto con l'esterno, prevedere dei dispositivi di assorbimento dell'umidità e della sporcizia per prevenire la formazione di graffi.

POLISHED SURFACE | SUPERFICIE LAPPATA | Surface adouci | Geläppte Oberfläche | Superficie bruñido | Полуполированный поверхность

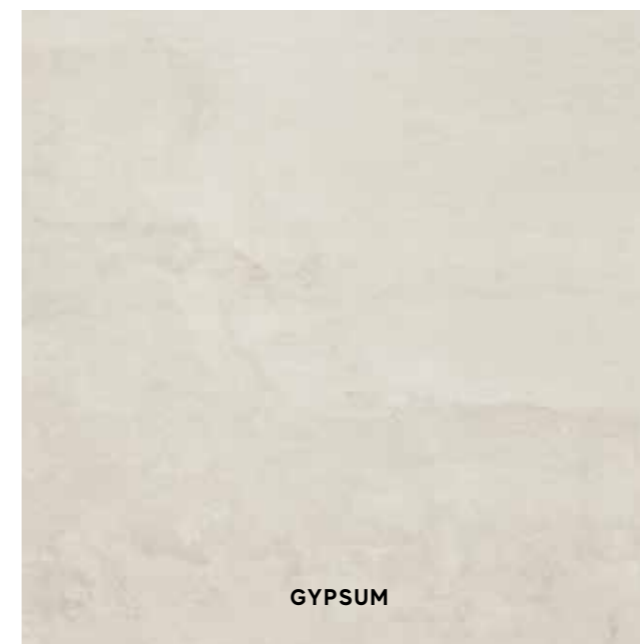

GYPSUM

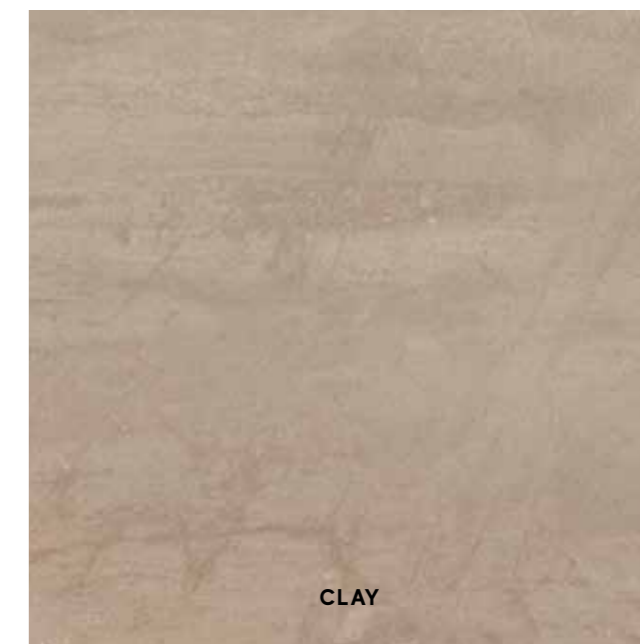

CLAY



PEARL



TOBACCO



CHROME

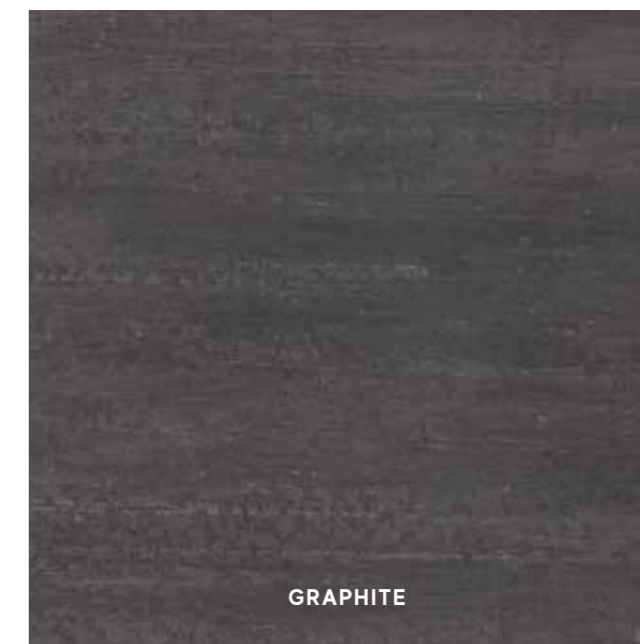

GRAPHITE



V3 MODERATE VARIATION

Gypsum,
Pearl,
Chrome,
Clay,
Tobacco,
Graphite

Mark Porcelain Tiles / Gres Porcellanato

DECOR RANGE / GAMMA DECORI



AMX9 Mark Gypsum Mosaico Matt
30x30 - 11³/₄"x11³/₄"

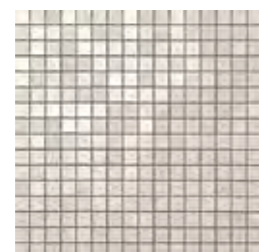

AMYF Mark Gypsum Mosaico Mix
30x30 - 11³/₄"x11³/₄"

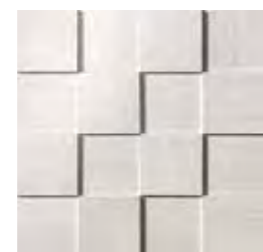

AMYL Mark Gypsum Mosaico 3D Lappato *
30x30 - 11³/₄"x11³/₄"



AM2K Mark Gypsum Esagono
30x35 - 11³/₄"x13³/₄"

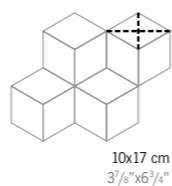
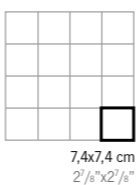
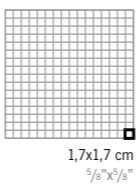
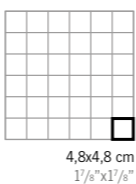

AMYA Mark Pearl Mosaico Matt
30x30 - 11³/₄"x11³/₄"

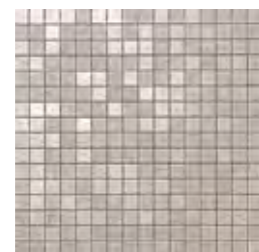

AMYG Mark Pearl Mosaico Mix
30x30 - 11³/₄"x11³/₄"

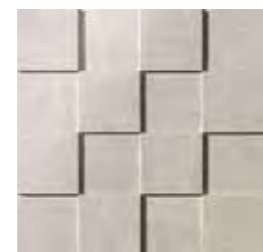

AMYM Mark Pearl Mosaico 3D Lappato *
30x30 - 11³/₄"x11³/₄"



AM2L Mark Pearl Esagono
30x35 - 11³/₄"x13³/₄"

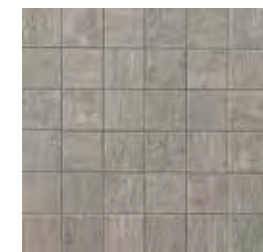

AMYB Mark Chrome Mosaico Matt
30x30 - 11³/₄"x11³/₄"

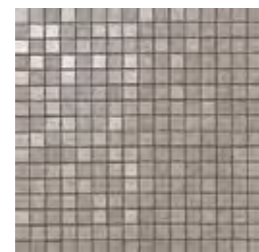

AMYH Mark Chrome Mosaico Mix
30x30 - 11³/₄"x11³/₄"

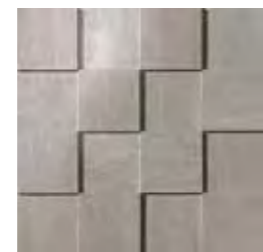

AMYN Mark Chrome Mosaico 3D Lappato *
30x30 - 11³/₄"x11³/₄"



AM2M Mark Chrome Esagono
30x35 - 11³/₄"x13³/₄"

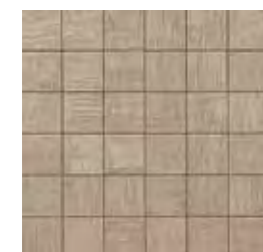

AMYC Mark Clay Mosaico Matt
30x30 - 11³/₄"x11³/₄"

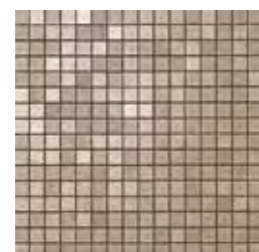

AMYI Mark Clay Mosaico Mix
30x30 - 11³/₄"x11³/₄"

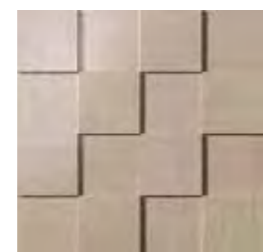

AMYO Mark Clay Mosaico 3D Lappato *
30x30 - 11³/₄"x11³/₄"



AM2N Mark Clay Esagono
30x35 - 11³/₄"x13³/₄"



AMYD Mark Tobacco Mosaico Matt
30x30 - 11³/₄"x11³/₄"

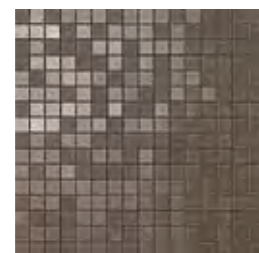

AMYJ Mark Tobacco Mosaico Mix
30x30 - 11³/₄"x11³/₄"

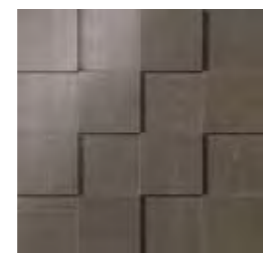

AMYP Mark Tobacco Mosaico 3D Lappato *
30x30 - 11³/₄"x11³/₄"



AM2O Mark Tobacco Esagono
30x35 - 11³/₄"x13³/₄"

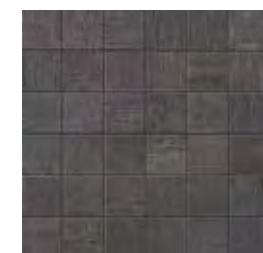

AMYE Mark Graphite Mosaico Matt
30x30 - 11³/₄"x11³/₄"

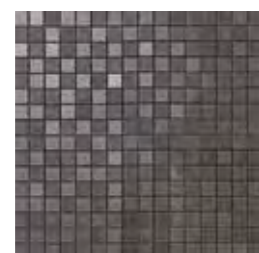

AMYK Mark Graphite Mosaico Mix
30x30 - 11³/₄"x11³/₄"

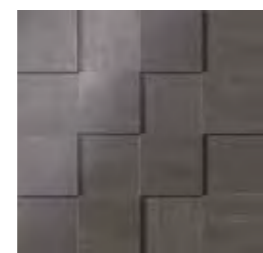

AMYQ Mark Graphite Mosaico 3D Lappato *
30x30 - 11³/₄"x11³/₄"



AM2P Mark Graphite Esagono
30x35 - 11³/₄"x13³/₄"

THE DECORATION CAN ONLY BE LAID ON THE WALL | IL DECORO SI PUÒ POSARE SOLO A RIVESTIMENTO
Décor uniquement mural | Das Dekor kann nur an der Wand verlegt werden | La decoración se puede colocar únicamente en paredes | Декор может быть уложен только на стену.

*** MULTI-THICKNESS MOSAIC, CLOSE JOINT INSTALLATION WITHOUT GROUTING.**
MOSAICO MULTISPESSORE, POSA SENZA STUCCATURA A GIUNTO UNITO.
Mosaïque multi-épaisseur, pose sans mastic avec joint nul.
Mosaik mit verschieden Stärken, fugenlose Verlegung ohne Mörtel.
Mosaico multiespesor, colocación sin mástique y sin juntas.
Мозаика разной толщины; укладка встык без затирки швов.



AMYR Mark Gypsum Brick
30x60 - 11³/₄"x23⁵/₈"



AMYS Mark Pearl Brick
30x60 - 11³/₄"x23⁵/₈"



AMYT Mark Chrome Brick
30x60 - 11³/₄"x23⁵/₈"



AMYU Mark Clay Brick
30x60 - 11³/₄"x23⁵/₈"



AMYV Mark Tobacco Brick
30x60 - 11³/₄"x23⁵/₈"



AMYW Mark Graphite Brick
30x60 - 11³/₄"x23⁵/₈"

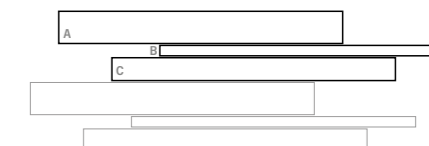

A 4,7x59,5 cm - 1⁷/₈"x11³/₈"
B 2,5x59,5 cm - 1"x23⁵/₈"
C 7,1x59,5 cm - 2⁷/₈"x23⁵/₈"



atlas concorde

Mark Porcelain Tiles / Gres Porcellanato

DECOR RANGE / GAMMA DECORI

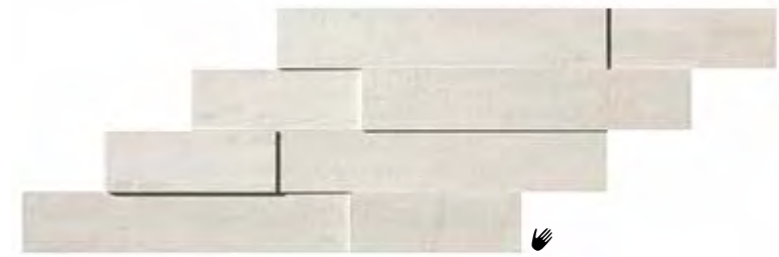

AM2R Mark Gypsum Brick 3D*
29x59 - 11³/₈"x23¹/₄"



AM2U Mark Clay Brick 3D*
29x59 - 11³/₈"x23¹/₄"



AM2S Mark Pearl Brick 3D*
29x59 - 11³/₈"x23¹/₄"



AM2V Mark Tobacco Brick 3D*
29x59 - 11³/₈"x23¹/₄"



AM2T Mark Chrome Brick 3D*
29x59 - 11³/₈"x23¹/₄"



AM2W Mark Graphite Brick 3D*
29x59 - 11³/₈"x23¹/₄"



AVV8 Mark Gypsum Listello 7x60 Lappato
7x60 - 2³/₄"x23⁵/₈"



AMY3 Mark Gypsum Angolo 7x7 Lappato
7x7 - 2³/₄"x2³/₄"



AVWA Mark Clay Listello 7x60 Lappato
7x60 - 2³/₄"x23⁵/₈"



AMY6 Mark Clay Angolo 7x7 Lappato
7x7 - 2³/₄"x2³/₄"



AVV9 Mark Pearl Listello 7x60 Lappato
7x60 - 2³/₄"x23⁵/₈"



AMY4 Mark Pearl Angolo 7x7 Lappato
7x7 - 2³/₄"x2³/₄"



AVWB Mark Tobacco Listello 7x60 Lappato
7x60 - 2³/₄"x23⁵/₈"



AMY7 Mark Tobacco Angolo 7x7 Lappato
7x7 - 2³/₄"x2³/₄"



AVV7 Mark Chrome Listello 7x60 Lappato
7x60 - 2³/₄"x23⁵/₈"



AMY5 Mark Chrome Angolo 7x7 Lappato
7x7 - 2³/₄"x2³/₄"



AVWC Mark Graphite Listello 7x60 Lappato
7x60 - 2³/₄"x23⁵/₈"



AMY8 Mark Graphite Angolo 7x7 Lappato
7x7 - 2³/₄"x2³/₄"



AMXY Mark Greca Mosaico Lappato
18,5x30 - 7¹/₄"x11³/₄"

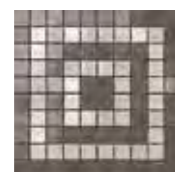

AMXZ Mark Angolo Mosaico Lappato
18,5x18,5 - 7¹/₄"x7¹/₄"

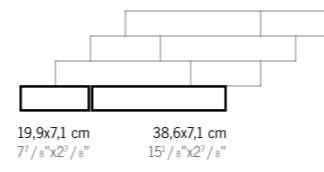

Pearl + Tobacco

THE DECORATION CAN ONLY BE LAID ON THE WALL | IL DECORO SI PUÒ POSARE SOLO A RIVESTIMENTO
Décor uniquement mural | Das Dekor kann nur an der Wand verlegt werden | La decoración se puede colocar únicamente en paredes | Декор может быть уложен только на стену.

TRIM TILES / PEZZI SPECIALI

p. 424

		Battiscopa 7,2x60 2 ⁷ / ₈ "x23 ⁵ / ₈ "		Battiscopa Lappato 7,2x60 2 ⁷ / ₈ "x23 ⁵ / ₈ "		Gradino* 30x60 11 ³ / ₄ "x23 ⁵ / ₈ "	Scalino* 33x90 13"x35 ³ / ₈ "	Scalino* 33x60 13"x23 ⁵ / ₈ "	Scalino Angolare* 33x33 13"x13"	Battiscopa Sag. Scala 7,2x30 - 2 ⁷ / ₈ "x11 ³ / ₄ "		Elemento L. Strutturato* 15x60 H. 4 5 ⁷ / ₈ "x23 ⁵ / ₈ " H. 1 ⁵ / ₈ "
		DX*	SX*									
Gypsum	AMY9	AVV4	AMØS	AMØY	AM1K	AM1Q	AMZO	AMZW	AM2C			
Pearl	AMZA	AVV5	AMØT	AMØZ	AM1L	AM1R	AMZQ	AM1W	AM2D			
Chrome	AMZC	AVV1	AMØU	AM1A	AM1M	AM1S	AMZR	AM1X	AM2E			
Clay	AMZD	AVV2	AMØV	AM1B	AM1N	AM1T	AMZS	AM1Y	AM2F			
Tobacco	AMZE	AVV6	AMØW	AM1C	AM1O	AM1U	AMZU	ANQY	AM2G			
Graphite	AMZF	AVV3	AMØX	AM1D	AM1P	AM1V	AMZV	AM1Z	AM2H			

* THESE PARTS ARE SUPPLIED TO ORDER | I PEZZI SONO DISPONIBILI SU ORDINAZIONE | Les pièces sont disponibles sur commande | Die Teile sind auf Bestellung lieferbar | Las piezas se hacen por encargo | Изготавливаются на заказ

UPEC p. 571





atlas concorde

mek
PORCELAIN & WALL TILES

Porcelain Tiles / Gres Porcellanato

COLOURED BODY PORCELAIN TILES - RECTIFIED MONOCALIBER
GRES PORCELLANATO COLORATO IN MASSA - RETTIFICATO MONOCALIBRO

LARGE SIZES p. 366



Sizes	Thickness	Surface finish
162x324 cm - 63 ³ / ₄ "x127 ¹ / ₂ " NON RECTIFIED - NON RETTIFICATO	± 12 mm	Matte
75x150 cm - 29 ¹ / ₂ "x59"	± 9 mm	Matte R10 A
45x90 cm - 17 ³ / ₄ "x35 ³ / ₈ "	± 9 mm	Matte R10 A
60x60 cm - 23 ⁵ / ₈ "x23 ⁵ / ₈ "	± 9 mm	Matte R10 A
30x60 cm - 11 ³ / ₄ "x23 ⁵ / ₈ "	± 9 mm	Matte R10 A

Wall Tiles / Rivestimento p. 532

WHITEBODY WALL TILES - RECTIFIED MONOCALIBER
RIVESTIMENTI IN PASTA BIANCA - RETTIFICATO MONOCALIBRO



Sizes	Thickness	Surface finish
50x110 cm - 19 ⁵ / ₈ "x43 ¹ / ₄ "	± 8,5 mm	Matte

3D Wall Tiles

Sizes	Thickness	Surface finish
50x110 cm - 19 ⁵ / ₈ "x43 ¹ / ₄ "	± 11 mm	Matte



Mek Porcelain Tiles / Gres Porcellanato

MATTE SURFACE / SUPERFICIE MATT

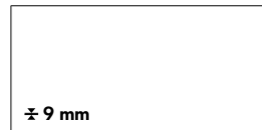

75x150 cm 29 1/2" x 59"
AT9Y Mek Light 75x150
AT9Z Mek Medium 75x150
AT9Ø Mek Bronze 75x150
AT9I Mek Dark 75x150

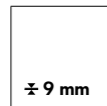

60x60 cm 23 3/8" x 23 3/8"
AUAA Mek Light 60x60
AUAC Mek Medium 60x60
AUAD Mek Bronze 60x60
AUAF Mek Dark 60x60

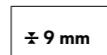

30x60 cm 11 3/4" x 23 3/8"
D226 Mek Light 30x60
D227 Mek Medium 30x60
D228 Mek Bronze 30x60
D229 Mek Dark 30x60

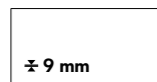

45x90 cm 17 3/4" x 35 3/8"
AT96 Mek Light 45x90
AT97 Mek Medium 45x90
AT98 Mek Bronze 45x90
AT99 Mek Dark 45x90

atlasPLAN p. 366



MATTE / MATT
162x324 cm 63 3/4" x 127 1/2"
> **NON RECTIFIED** / NON RETTIFICATO
ANVS Mek Bronze Matt ± 12 mm
ANVT Mek Bronze Matt ± 12 mm ST *
ANVQ Mek Dark Matt ± 12 mm
ANVR Mek Dark Matt ± 12 mm ST *

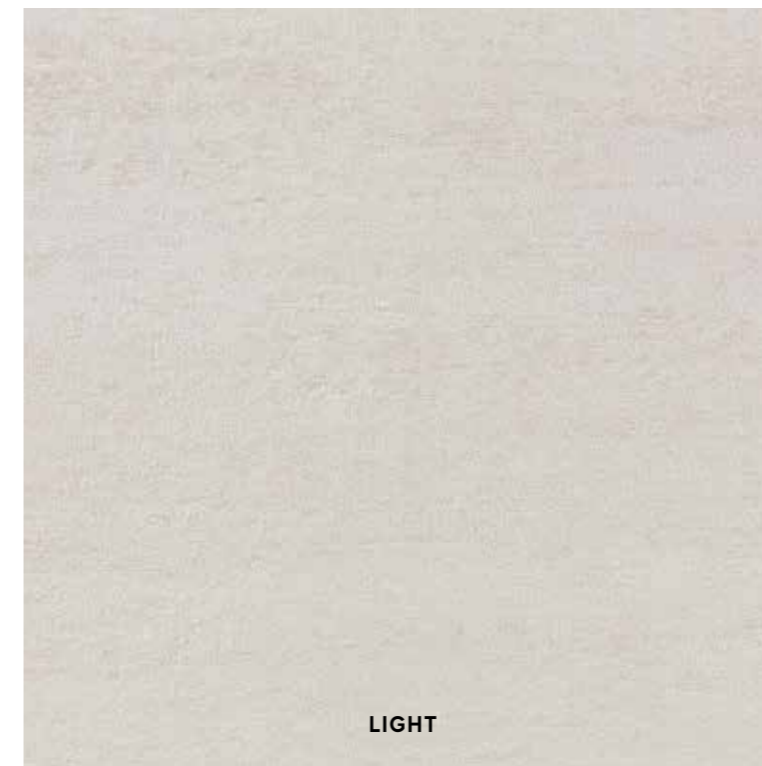

LIGHT

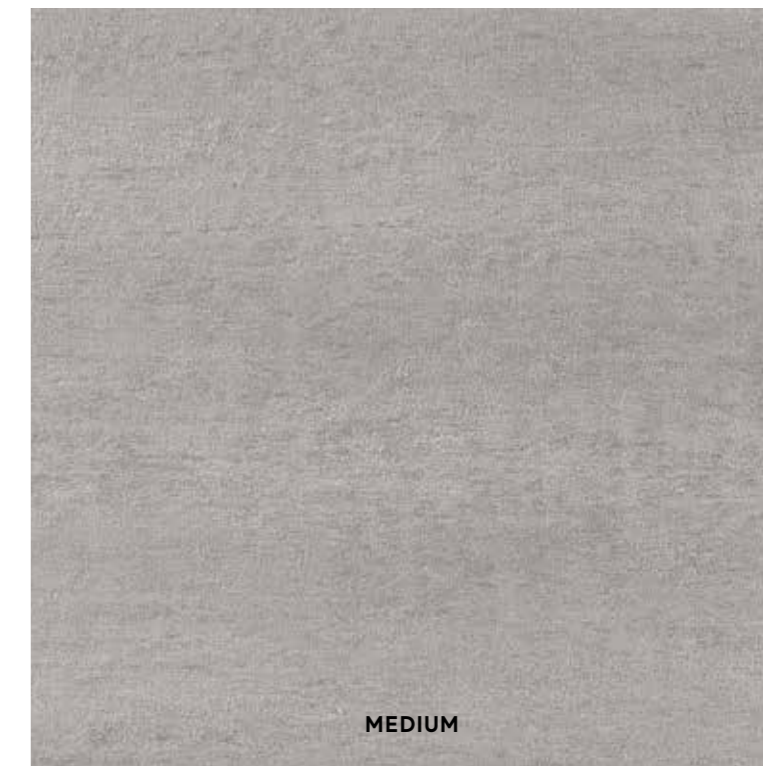

MEDIUM

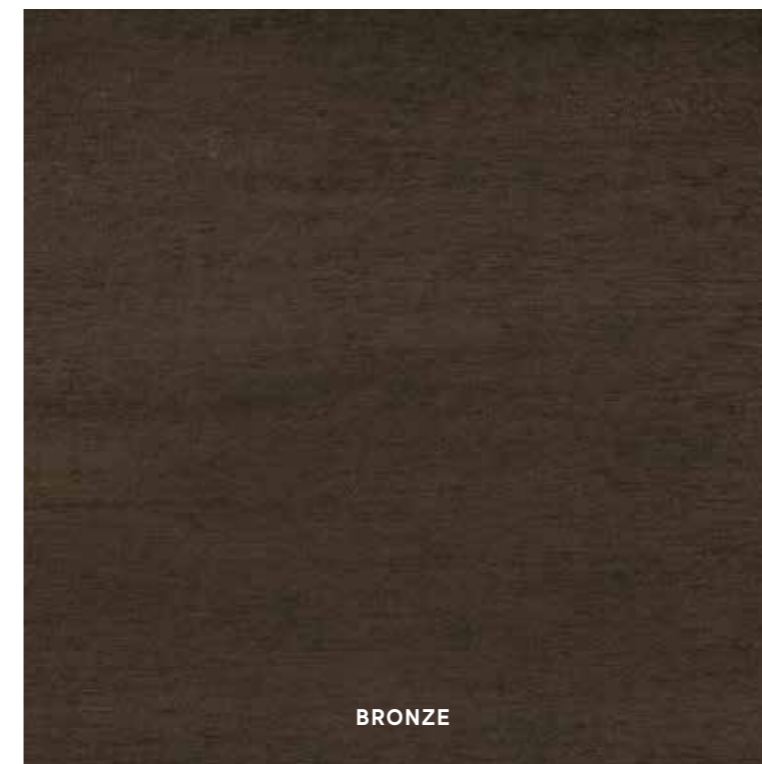

BRONZE

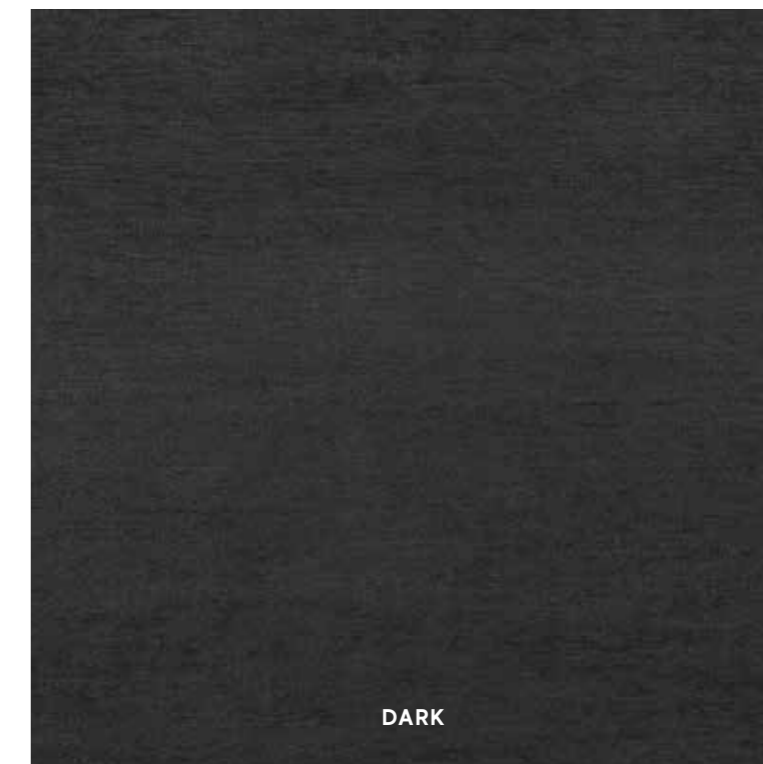

DARK



MATTE SURFACE | SUPERFICIE MATT | Surface Mat | Matt oberfläche | Superficie Mate | Матовая поверхность

* WITH FIBERGLASS MESH | VERSIONE STUOIATA | Version à nattes | Ausführung mit Glasfasermatte | Versión con malla | С упрочнением из стекловолокна
NON RECTIFIED | NON RETTIFICATO | Non rectifié | Nicht rektifiziert | No rectificada | Неретифицированные



**V2
SLIGHT
VARIATION**
Light,
Medium,
Bronze,
Dark

Mek Porcelain Tiles / Gres Porcellanato

DECOR RANGE / GAMMA DECORI



AMKY Mek Light Mosaico
30x30 - 11³/₄"x11³/₄"



AMKZ Mek Medium Mosaico
30x30 - 11³/₄"x11³/₄"



AMKØ Mek Bronze Mosaico
30x30 - 11³/₄"x11³/₄"

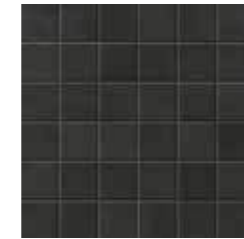

AMK1 Mek Dark Mosaico
30x30 - 11³/₄"x11³/₄"

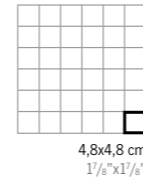

AMKJ Mek Light Mosaico Zip
27x28 - 10⁵/₈"x11"



AMKK Mek Medium Mosaico Zip
27x28 - 10⁵/₈"x11"



AMKN Mek Bronze Mosaico Zip
27x28 - 10⁵/₈"x11"



AMKO Mek Dark Mosaico Zip
27x28 - 10⁵/₈"x11"

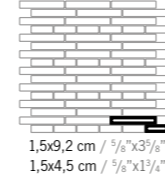

AMKQ Mek Light Mosaico Prisma
36x36 - 14¹/₈"x14¹/₈"



AMKV Mek Medium Mosaico Prisma
36x36 - 14¹/₈"x14¹/₈"

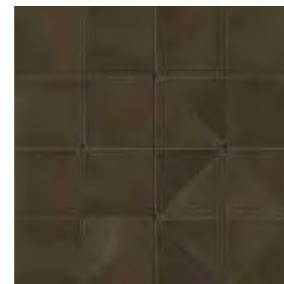

AMKW Mek Bronze Mosaico Prisma
36x36 - 14¹/₈"x14¹/₈"



AMKX Mek Dark Mosaico Prisma
36x36 - 14¹/₈"x14¹/₈"

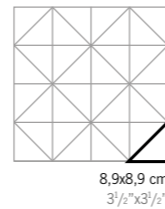

AMKG Mek Light Esagono
30x35 - 11³/₄"x13³/₄"



AMKF Mek Medium Esagono
30x35 - 11³/₄"x13³/₄"



AMKH Mek Bronze Esagono
30x35 - 11³/₄"x13³/₄"



AMKI Mek Dark Esagono
30x35 - 11³/₄"x13³/₄"

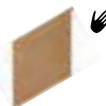
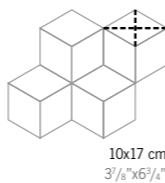

AMPJ Mek Rombo Gold *
10x17 - 3⁷/₈"x6⁷/₈"

* **LOOSE TILES TO ADD FREELY TO THE ESAGONO MOSAIC.**
TESSERE SFUSE DA INSERIRE LIBERAMENTE ALL'INTERNO DI MOSAICO ESAGONO.
Pièces à utiliser librement pour Mosaico Esagono.
Lose Steinchen, die frei innerhalb des Sechseckigen Mosaiks eingefügt werden können.
Teselas a granel para insertar libremente en el interior de Mosaico Hexagonal.
Мозаичные элементы для произвольного включения в мозаику Esagono.

THE DECORATION CAN ONLY BE LAID ON THE WALL | IL DECORO SI PUÒ POSARE SOLO A RIVESTIMENTO
Décor uniquement mural | Das Dekor kann nur an der Wand verlegt werden | La decoración se puede colocar únicamente en paredes | Декор может быть уложен только на стену.

TRIM TILES / PEZZI SPECIALI

p. 424

		Battiscopa 7,2x60 2 ⁷ / ₈ "x23 ³ / ₈ "	Battiscopa Digitale 4,6x60 1 ³ / ₄ "x23 ³ / ₈ "	Gradino * 30x60 11 ³ / ₄ "x23 ³ / ₈ "	Scalino * 33x150 13"x59"	Scalino * 33x60 13"x23 ³ / ₈ "	Scalino Angolare 33x33 - 13"x13"	Battiscopa Sag. Scala 7,2x30 - 2 ⁷ / ₈ "x11 ³ / ₄ "		
							DX *	SX *	DX *	SX *
Light	AMPN	AMPU	AMPY	AMQD	AMP9	AMQH	AMQL	AMQP	AMQT	
Medium	AMPO	AMPV	AMPZ	AMQE	AMQA	AMQI	AMQM	AMQQ	AMQU	
Bronze	AMPQ	AMPW	AMPØ	AMQF	AMQB	AMQJ	AMQN	AMQR	AMQV	
Dark	AMPR	AMPX	AMP8	AMQG	AMQC	AMQK	AMQO	AMQS	AMQW	

* THESE PARTS ARE SUPPLIED TO ORDER | PEZZI SONO DISPONIBILI SU ORDINAZIONE | Les pièces sont disponibles sur commande | Die Teile sind auf Bestellung lieferbar | Las piezas se hacen por encargo | Изготавливаются на заказ

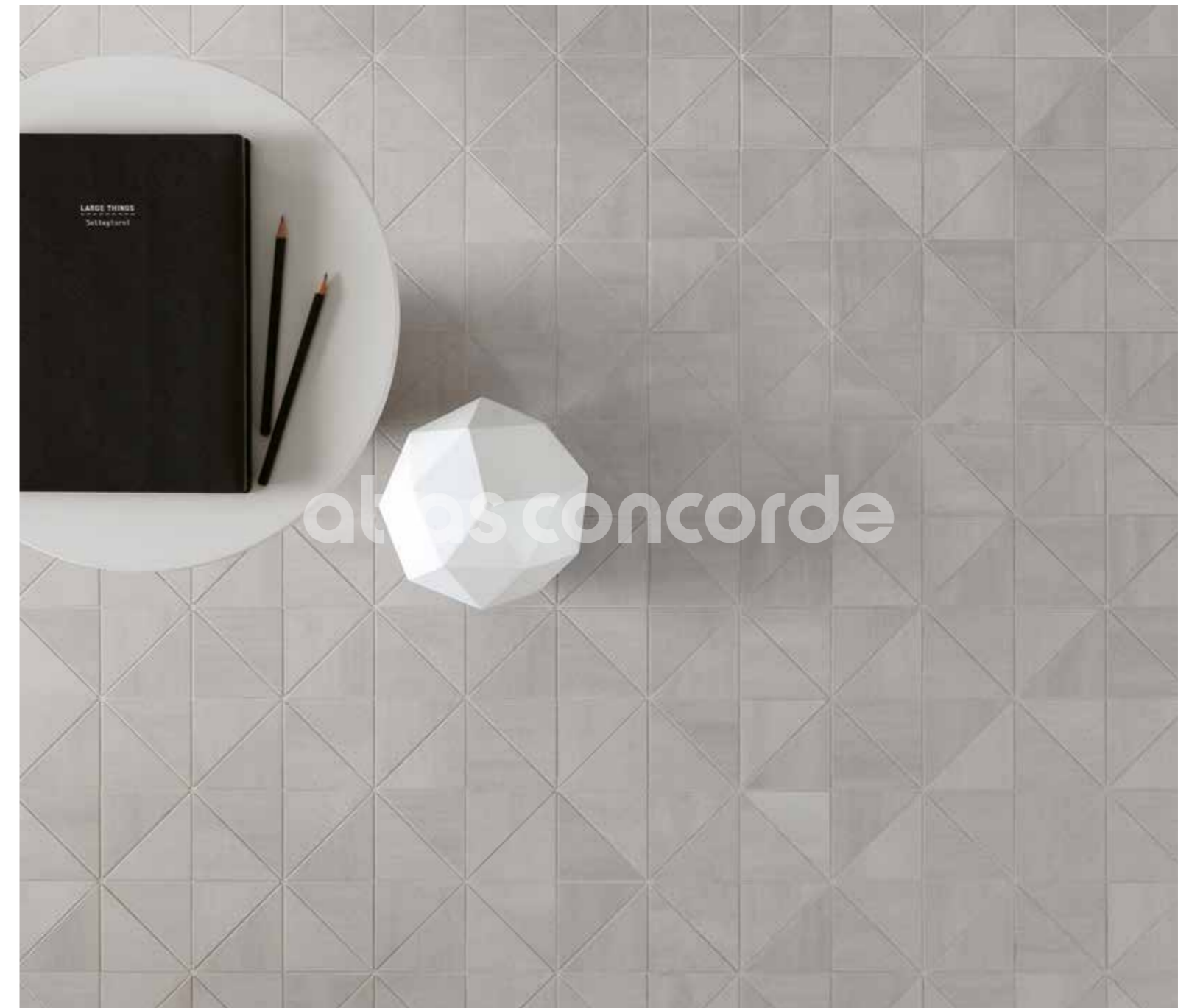



Mek Wall Tiles / Rivestimento

MATTE SURFACE / SUPERFICIE MATT

± 8,5 mm

50x110 cm 19⁹/₁₆"x43¹/₄"

- 4MKL Mek Light 50x110
- 4MKM Mek Medium 50x110
- 4MKR Mek Rose 50x110
- 4MKB Mek Blue 50x110

TRIM TILES / PEZZI SPECIALI

LMPC Mek Light Spigolo
0,8x25 cm - 3¹/₈"x8⁷/₈"

LMPH Mek Medium Spigolo
0,8x25 cm - 3¹/₈"x8⁷/₈"

LMPQ Mek Rose Spigolo
0,8x25 cm - 3¹/₈"x8⁷/₈"

LMPU Mek Blue Spigolo
0,8x25 cm - 3¹/₈"x8⁷/₈"

AMKL Mek Light Spigolo A.E.
0,8x0,8 cm - 3¹/₈"x3³/₈"

AMKM Mek Medium Spigolo A.E.
0,8x0,8 cm - 3¹/₈"x3³/₈"

AMKR Mek Rose Spigolo A.E.
0,8x0,8 cm - 3¹/₈"x3³/₈"

AMKU Mek Blue Spigolo A.E.
0,8x0,8 cm - 3¹/₈"x3³/₈"

3D WALL TILES / RIVESTIMENTO 3D

± 11 mm

50x110 cm 19⁹/₁₆"x43¹/₄"

- 4MKI Mek 3D Fold Light 110
- 4MKE Mek 3D Fold Medium 110
- 4MKO Mek 3D Ultra Blade Rose 110
- 4MKU Mek 3D Ultra Blade Blue 110

LM1L Mek Light Spigolo 10mm *
1x20 cm - 3¹/₈"x7⁷/₈"

LM1M Mek Medium Spigolo 10mm *
1x20 cm - 3¹/₈"x7⁷/₈"

LM1R Mek Rose Spigolo 10mm *
1x20 cm - 3¹/₈"x7⁷/₈"

LM1U Mek Blue Spigolo 10mm *
1x20 cm - 3¹/₈"x7⁷/₈"

DECORATIVE RANGE / GAMMA DECORATIVA

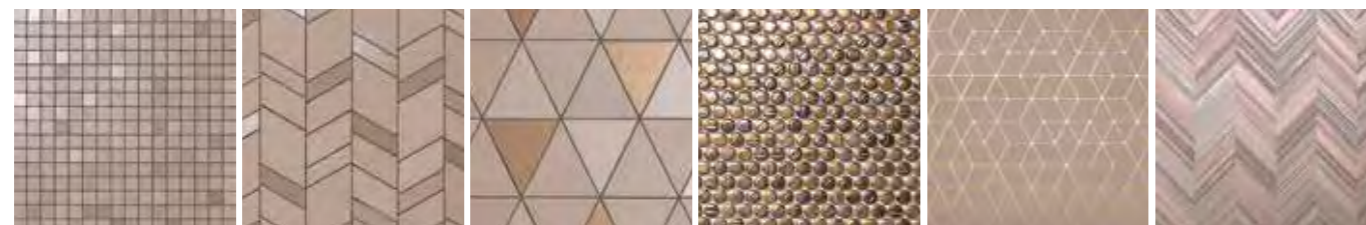

MOSAICO Q WALL

MOSAICO CHEVRON WALL

MOSAICO DIAMOND WALL

GOLD CIRCLES

HEXAGON

WALLPAPER

* THESE PARTS ARE SUPPLIED TO ORDER. I PEZZI SONO DISPONIBILI SU ORDINAZIONE
Les pièces sont disponibles sur commande | Die Teile sind auf Bestellung lieferbar | Las piezas se hacen por encargo | Изготавливаются на заказ



The 10 mm edge matches three-dimensional wall tiles having a 10-11 mm thickness. / Lo spigolo 10 mm si abbina a rivestimenti tridimensionali di spessore 10-11 mm / Le bord 10 mm s'adapte aux revêtements tridimensionnels épaisseur 10-11 mm. / Die 10 mm Kante ist mit dreidimensionalen Wandfliesen mit einer Dicke von 10-11 mm kombinierbar. / La arista de 10 mm se combina con revestimientos tridimensionales de 10-11 mm de grosor. / Угловой элемент 10 мм сочетается с трехмерной настенной плиткой толщиной 10-11 мм.

MATTE SURFACE | SUPERFICIE MATT | Surface Mat | Matt oberfläche | Superficie Mate | Матовая поверхность

WALL TILES p. 532



LIGHT



3D FOLD LIGHT



MEDIUM



3D FOLD MEDIUM



ROSE



3D ULTRA BLADE ROSE

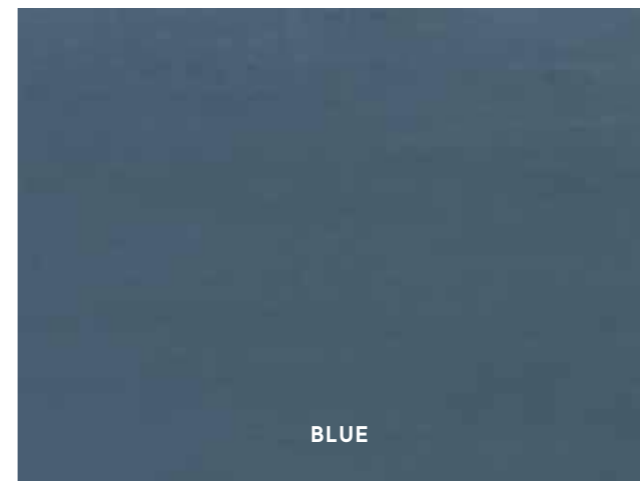

BLUE

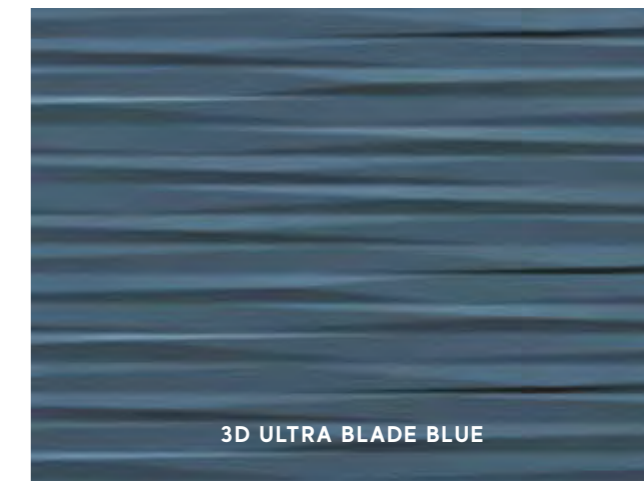

3D ULTRA BLADE BLUE



V2 SLIGHT VARIATION

Light / 3D Fold Light
Medium / 3D Fold Medium
Rose / 3D Ultra Blade Rose
Blue / 3D Ultra Blade Blue



RAW
PORCELAIN & WALL TILES



Porcelain Tiles / Gres Porcellanato

COLOURED BODY PORCELAIN TILES - RECTIFIED MONOCALIBER
GRES PORCELLANATO COLORATO IN MASSA - RETTIFICATO MONOCALIBRO

LARGE SIZES p. 366

Sizes	Thickness	Surface finish
120x278 cm - 47 ¹ / ₄ "x109 ¹ / ₂ "	± 6 mm	Matte R9 A
120x120 cm - 47 ¹ / ₄ "x47 ¹ / ₄ "	± 9 mm	Matte R10 A+B
75x150 cm - 29 ¹ / ₂ "x59"	± 9 mm	Matte R10 A+B
75x75 cm - 29 ¹ / ₂ "x29 ¹ / ₂ "	± 9 mm	Matte R10 A+B
37,5x75 cm - 14 ³ / ₄ "x29 ¹ / ₂ "	± 9 mm	Matte R10 A+B
60x60 cm - 23 ⁵ / ₈ "x23 ⁵ / ₈ "	± 9 mm	Matte R10 A+B
30x60 cm - 11 ³ / ₄ "x23 ⁵ / ₈ "	± 9 mm	Matte R10 A+B

Outdoor Paving and Wet Areas

OUTDOOR PAVING p. 408

Sizes	Thickness	Surface finish
37,5x75 cm - 14 ³ / ₄ "x29 ¹ / ₂ "	± 9 mm	Grip R11 A+B+C
120x120 cm - 47 ¹ / ₄ "x47 ¹ / ₄ "	± 20 mm	Textured R11 A+B+C
60x120 cm - 23 ⁵ / ₈ "x47 ¹ / ₄ "	± 20 mm	Textured R11 A+B+C



Wall Tiles / Rivestimento p. 538

WHITEBODY WALL TILES - RECTIFIED MONOCALIBER
RIVESTIMENTI IN PASTA BIANCA - RETTIFICATO MONOCALIBRO

Sizes	Thickness	Surface finish
50x110 cm - 19 ⁵ / ₈ "x43 ¹ / ₄ "	± 8,5 mm	Matte

3D Wall Tiles

Sizes	Thickness	Surface finish
50x110 cm - 19 ⁵ / ₈ "x43 ¹ / ₄ "	± 10 mm	Matte



Raw Porcelain Tiles / Gres Porcellanato

MATTE SURFACE / SUPERFICIE MATT



120x278 cm 47 1/4" x 109 1/2"

APMW Raw White 120x278
APMX Raw Pearl 120x278
APMY Raw Sand 120x278
APMZ Raw Mud 120x278

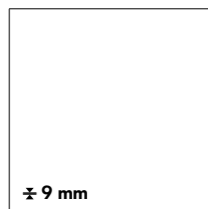

120x120 cm 47 1/4" x 47 1/4"

APMK Raw White 120x120
APML Raw Pearl 120x120
APMU Raw Sand 120x120
APMV Raw Mud 120x120

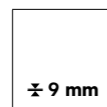

60x60 cm 23 5/8" x 23 5/8"

APMB Raw White 60x60
APMD Raw Pearl 60x60
APME Raw Sand 60x60
APMF Raw Mud 60x60

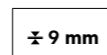

30x60 cm 11 3/4" x 23 5/8"

APMG Raw White 30x60
APMH Raw Pearl 30x60
APMI Raw Sand 30x60
APMJ Raw Mud 30x60

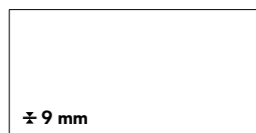

75x150 cm 29 1/2" x 59"

APKC Raw White 75x150
APKD Raw Pearl 75x150
APKE Raw Sand 75x150
APKF Raw Mud 75x150

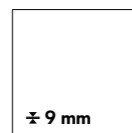

75x75 cm 29 1/2" x 29 1/2"

APLW Raw White 75x75
APLX Raw Pearl 75x75
APLY Raw Sand 75x75
APLZ Raw Mud 75x75

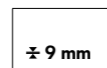

37,5x75 cm 14 3/4" x 29 1/2"

APLØ Raw White 37,5x75
APL1 Raw Pearl 37,5x75
APL2 Raw Sand 37,5x75
APL5 Raw Mud 37,5x75



GRIP SURFACE / SUPERFICIE GRIP

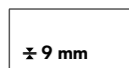

37,5x75 cm 14 3/4" x 29 1/2"

APL7 Raw White 37,5x75 Grip
APL8 Raw Pearl 37,5x75 Grip
APL9 Raw Sand 37,5x75 Grip
APMA Raw Mud 37,5x75 Grip



OUTDOOR PAVING ± 20 mm / PAVIMENTI DA ESTERNO ± 20 mm

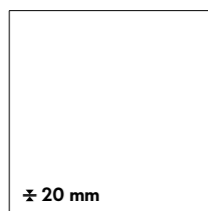

120x120 cm 47 1/4" x 47 1/4"

A06K Raw White 120x120 20 mm
A06M Raw Pearl 120x120 20 mm
A06O Raw Sand 120x120 20 mm
A06P Raw Mud 120x120 20 mm

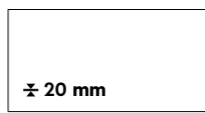

60x120 cm 23 5/8" x 47 1/4"

A0JO Raw White 60x120 20 mm
A0JP Raw Pearl 60x120 20 mm
A0JQ Raw Sand 60x120 20 mm
A0JR Raw Mud 60x120 20 mm

MATTE / GRIP



WHITE



PEARL



SAND



MUD

OUTDOOR PAVING ± 20 mm



WHITE



PEARL



SAND



MUD



V3
MODERATE
VARIATION
White,
Pearl,
Sand, Mud

MATTE SURFACE | SUPERFICIE MATT | Surface Mat | Matt oberfläche | Superficie Mate | Матовая поверхность
GRIP SURFACE | SUPERFICIE GRIP | Surface grip | Grip oberfläche | Superficie Grip | Grip поверхность
OUTDOOR PAVING | PAVIMENTI DA ESTERNO | Sols d'extérieur | Bodenbeläge für Außenbereiche | Pavimentos para exteriores | Уличная плитка

Raw Porcelain Tiles / Gres Porcellanato

DECOR RANGE / GAMMA DECORI

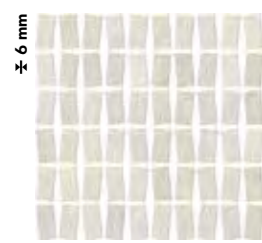

A00J Raw White Mosaico Castle *
29x29,2 - 11³/₈"x11³/₈"

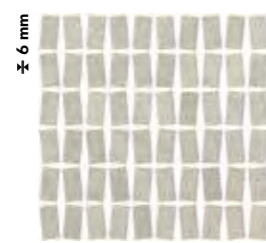

A00K Raw Pearl Mosaico Castle *
29x29,2 - 11³/₈"x11³/₈"

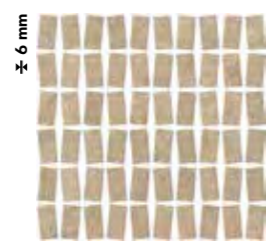

A00L Raw Sand Mosaico Castle *
29x29,2 - 11³/₈"x11³/₈"

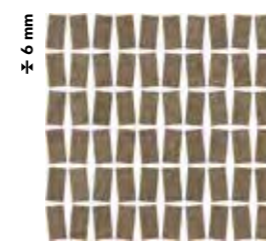

A00M Raw Mud Mosaico Castle *
29x29,2 - 11³/₈"x11³/₈"

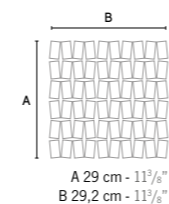

A0Z9 Raw White Mosaico Esagono
35,2x30,5 - 13⁷/₈"x12"



A00C Raw Pearl Mosaico Esagono
35,2x30,5 - 13⁷/₈"x12"



A00D Raw Sand Mosaico Esagono
35,2x30,5 - 13⁷/₈"x12"



A00E Raw Mud Mosaico Esagono
35,2x30,5 - 13⁷/₈"x12"

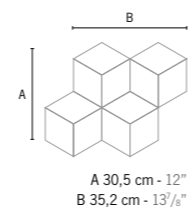

A0Z0 Raw White Mosaico Matt
30x30 - 11³/₄"x11³/₄"



A0Z6 Raw Pearl Mosaico Matt
30x30 - 11³/₄"x11³/₄"

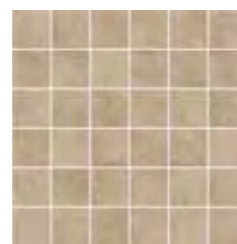

A0Z7 Raw Sand Mosaico Matt
30x30 - 11³/₄"x11³/₄"

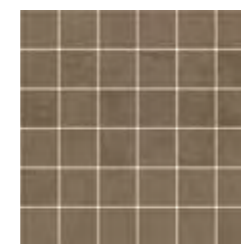

A0Z8 Raw Mud Mosaico Matt
30x30 - 11³/₄"x11³/₄"

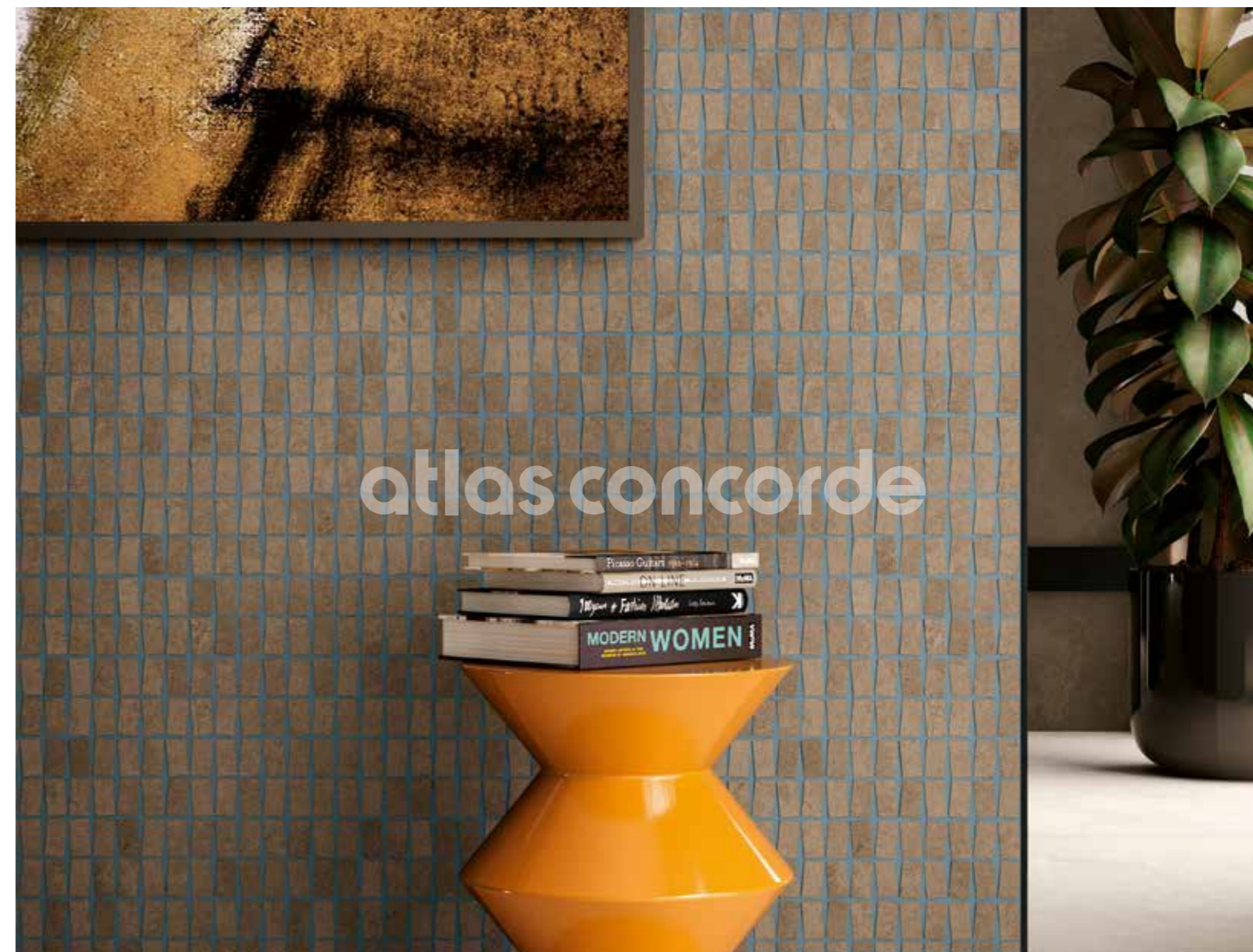

TRIM TILES / PEZZI SPECIALI

p. 424

UPEC p. 571

Color	Battiscopa		Gradino *		Scalino *			Scalino Angolare *		Corner ± 6 mm *	Corner A.E. ± 6 mm *	Battiscopa Sag. Scala		Elemento L Grip *
	7,2x150 - 2 ⁷ / ₈ "x59"	7,2x60 - 2 ⁷ / ₈ "x23 ⁵ / ₈ "	37,5x75 - 14 ³ / ₄ "x29 ¹ / ₂ "	30x60 - 11 ³ / ₄ "x23 ⁵ / ₈ "	37,5x150 - 14 ³ / ₄ "x59"	33x120 - 14 ³ / ₄ "x59"	33x60 - 13"x23 ⁵ / ₈ "	37,5x37,5 - 14 ³ / ₄ "x14 ³ / ₄ "	33x33 - 13"x13"			1x120 - 3 ⁷ / ₈ "x47 ¹ / ₄ "	1x1 - 3 ⁷ / ₈ "x2 ⁷ / ₈ "	
White	A2AD	A199	A2AT	A2AP	A2A8	A2A4	A2AX	A2BG	A2BC	A191	A195	A2AL	A2AH	A2BK
Pearl	A2AE	A2AA	A2AU	A2AQ	A2A9	A2A5	A2AY	A2BH	A2BD	A192	A196	A2AM	A2AI	A2BL
Sand	A2AF	A2AB	A2AV	A2AR	A2BA	A2A6	A2AZ	A2BI	A2BE	A193	A197	A2AN	A2AJ	A2BM
Mud	A2AG	A2AC	A2AW	A2AS	A2BB	A2A7	A2A3	A2BJ	A2BF	A194	A198	A2AO	A2AK	A2BN

* These mosaics allow you to customize a wall by choosing the color of the grout during the laying phase. The colors presented in these pages are mood suggestions and purely indicative. / Questi mosaici permettono di personalizzare la parete attraverso la scelta del colore dello stucco durante la fase di posa. I colori presentati in queste pagine sono suggerimenti di mood e sono puramente indicativi. / Ces mosaïques permettent de personnaliser le mur moyennant le choix du coloris du joint pendant la phase de pose. Les coloris présentés sur ces pages sont des idées de mood fournies qu'à titre purement indicatif. / Diese Mosaik können zur Personalisierung der Wand mit Fugenmassen in Farben nach Wahl verfugt werden. Die auf diesen Seiten abgebildeten Farben verstehen sich als unverbindliche Beispiele für den erzielbaren Gesamteindruck. / Con estos mosaicos es posible llevar a cabo cualquier idea de personalización de la pared, con la elección del color del estuco durante la fase de colocación. Los colores que les presentamos en estas páginas son sugerencias de estados de ánimo ("mood") y puramente indicativos. / Эта мозаика позволяет индивидуализировать стену путем выбора цвета шовной затирки. Цвета, представленные на этих страницах, приведены в качестве примеров и носят ориентировочный характер.

* THESE PARTS ARE SUPPLIED TO ORDER | I PEZZI SONO DISPONIBILI SU ORDINAZIONE | Les pièces sont disponibles sur commande | Die Teile sind auf Bestellung lieferbar | Las piezas se hacen por encargo | Изготавливаются на заказ



Raw Wall Tiles / Rivestimento

MATTE SURFACE / SUPERFICIE MATT

± 8,5 mm

50x110 cm 19⁵/₈"x43¹/₄"

- 4R1W Raw White 50x110
- 4R1P Raw Pearl 50x110
- 4R1S Raw Sand 50x110
- 4R1B Raw Blue 50x110
- 4R1R Raw Rose 50x110
- 4R1E Raw Petroleum 50x110

3D WALL TILES / RIVESTIMENTO 3D

± 10 mm

50x110 cm 19⁵/₈"x43¹/₄"

- 4R3W Raw 3D Scratch White 50x110
- 4R3P Raw 3D Scratch Pearl 50x110
- 4R3B Raw 3D Scratch Blue 50x110
- 4R3E Raw 3D Scratch Petroleum 50x110

WALL TILES p. 538

TRIM TILES / PEZZI SPECIALI

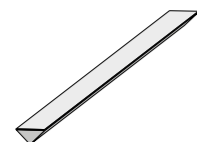

1,4x50 cm - ⁵/₈"x19⁵/₈"

- LR1W Raw White Corner 50 *
- LR1P Raw Pearl Corner 50 *
- LR1S Raw Sand Corner 50 *
- LR1B Raw Blue Corner 50 *
- LR1R Raw Rose Corner 50 *
- LR1E Raw Petroleum Corner 50 *

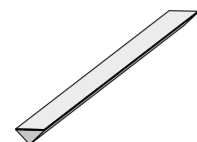

1,4x50 cm - ⁵/₈"x19⁵/₈"

- LR3W Raw 3D Scratch White Corner 50 *
- LR3A Raw 3D Scratch Pearl Corner 50 *
- LR3L Raw 3D Scratch Blue Corner 50 *
- LR3E Raw 3D Scratch Petroleum Corner 50 *



1,4x1,4 cm - ⁵/₈"x⁵/₈"

- A0RW Raw White Corner A.E. 1,4 *
- A0RP Raw Pearl Corner A.E. 1,4 *
- A0RS Raw Sand Corner A.E. 1,4 *
- A0RB Raw Blue Corner A.E. 1,4 *
- A0RR Raw Rose Corner A.E. 1,4 *
- A0RC Raw Petroleum Corner A.E. 1,4 *

DECORATIVE RANGE / GAMMA DECORATIVA

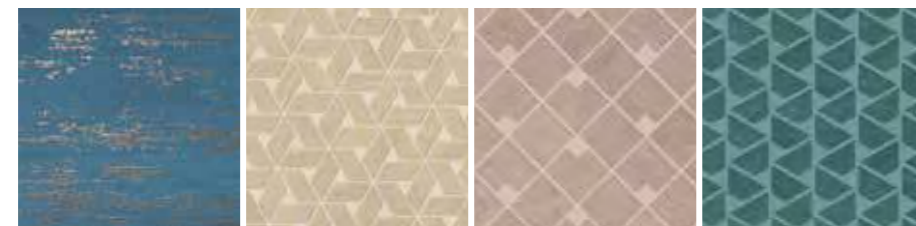

GOLD

MOSAICO TWIST

MOSAICO BLOCK

MOSAICO FLAG

* THESE PARTS ARE SUPPLIED TO ORDER . I PEZZI SONO DISPONIBILI SU ORDINAZIONE
Les pièces sont disponibles sur commande | Die Teile sind auf Bestellung lieferbar | Las piezas se hacen por encargo | Изготавливаются на заказ



atlas concorde

MATTE SURFACE | SUPERFICIE MATT | Surface Mat | Matt oberfläche | Superficie Mate | Матовая поверхность



SAND



WHITE

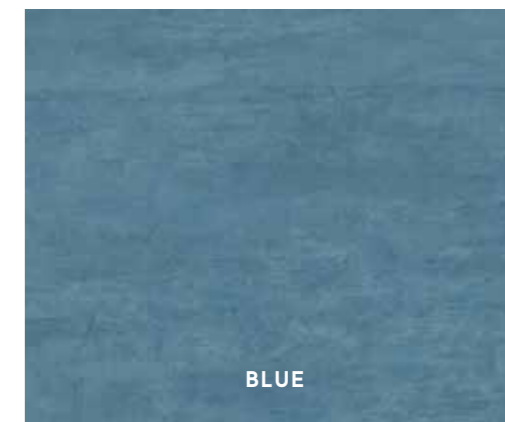

BLUE



ROSE

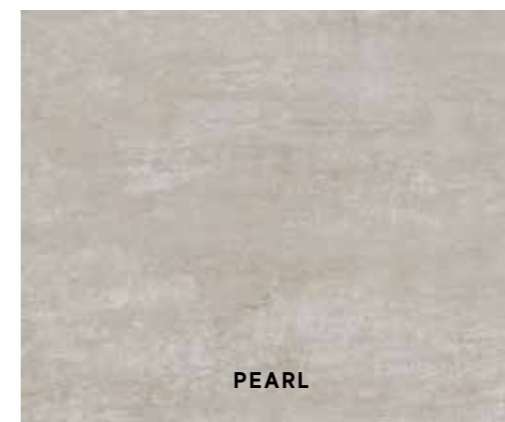

PEARL



PETROLEUM



3D SCRATCH WHITE

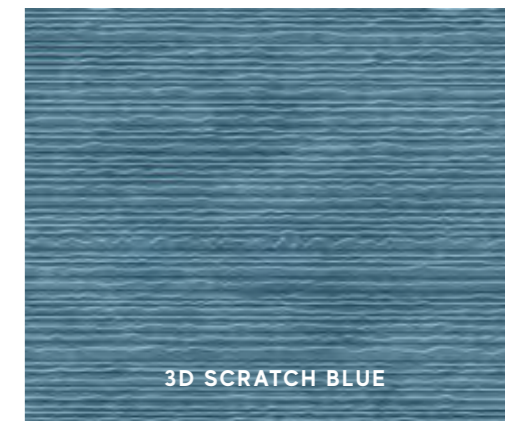

3D SCRATCH BLUE



3D SCRATCH PEARL

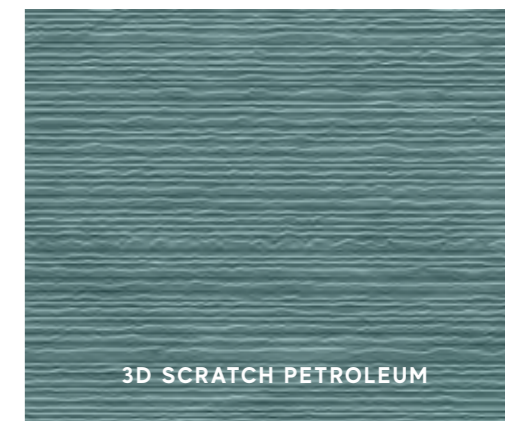

3D SCRATCH PETROLEUM



**V2
SLIGHT
VARIATION**

- White,
- Pearl,
- Blue,
- Petroleum,
- Rose, Sand
- 3D Scratch White,
- 3D Scratch Pearl,
- 3D Scratch Blue,
- 3D Scratch Petroleum

atlas concorde

MARVEL

PORCELAIN&WALL TILES

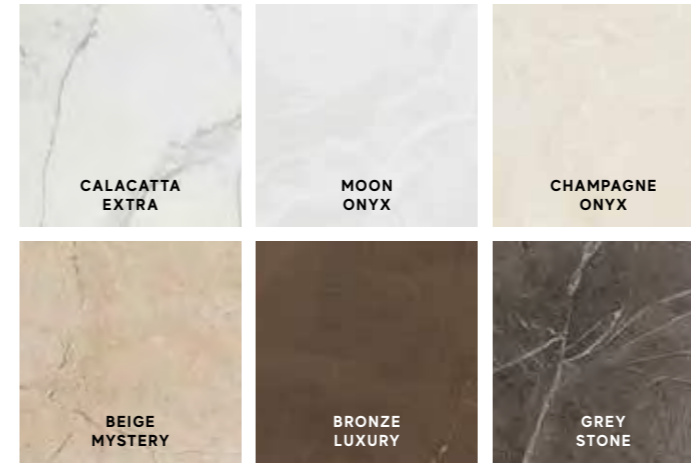

Porcelain Tiles / Gres Porcellanato

COLOURED BODY PORCELAIN TILES - RECTIFIED MONOCALIBER
GRES PORCELLANATO COLORATO IN MASSA - RETTIFICATO MONOCALIBRO

LARGE SIZES p. 366

Sizes	Thickness	Surface finish
162x324 cm - 63 ³ / ₄ "x127 ¹ / ₂ " * NON RECTIFIED - NON RETTIFICATO	± 6-12-20 mm	Lappato Lux I Silk
160x320 cm - 63"x126"	± 6 mm	Polished I Matte R9 A
160x160 cm - 63"x63"	± 6 mm	Polished I Matte R9 A
120x278 cm - 47 ¹ / ₄ "x109 ¹ / ₂ "	± 6 mm	Polished I Matte R9 A
120x240 cm - 47 ¹ / ₄ "x94 ¹ / ₂ "	± 9 mm	Polished
120x120 cm - 47 ¹ / ₄ "x47 ¹ / ₄ "	± 9 mm	Polished I Matte R9 A
60x120 cm - 23 ⁵ / ₈ "x47 ¹ / ₄ "	± 9 mm	Polished I Matte R9 A
75x150 cm - 29 ¹ / ₂ "x59"	± 9 mm	Polished I Matte R9 A
75x75 cm - 29 ¹ / ₂ "x29 ¹ / ₂ "	± 9 mm	Polished I Matte R9 A
45x90 cm - 17 ³ / ₄ "x35 ³ / ₈ "	± 9 mm	Polished I Matte R9 A
60x60 cm - 23 ⁵ / ₈ "x23 ⁵ / ₈ "	± 9 mm	Polished I Matte R9 A
30x60 cm - 11 ³ / ₄ "x23 ⁵ / ₈ "	± 9 mm	Polished I Matte R9 A

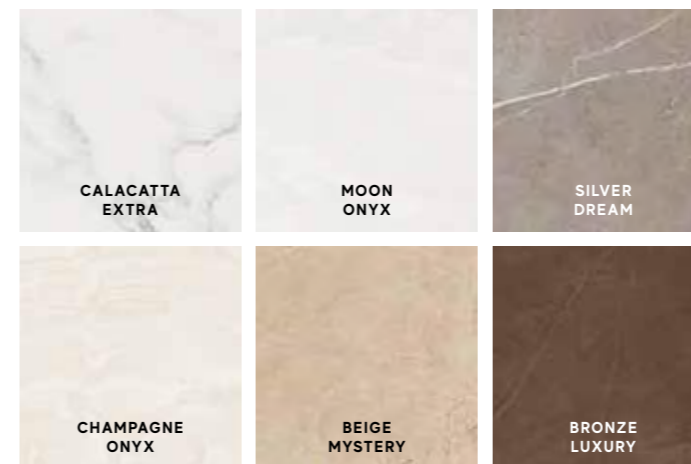

Wall Tiles / Rivestimento p. 494

WHITEBODY WALL TILES - RECTIFIED MONOCALIBER
RIVESTIMENTI IN PASTA BIANCA - RETTIFICATO MONOCALIBRO

Sizes	Thickness	Surface finish
50x110 cm - 19 ⁵ / ₈ "x43 ¹ / ₄ "	± 8,5 mm	Shiny
40x80 cm - 15 ³ / ₄ "x31 ¹ / ₂ "	± 8,5 mm	Shiny
30,5x91,5 cm - 12"x36"	± 8,5 mm	Shiny
30,5x56 cm - 12"x22"	± 8,5 mm	Shiny
8x31,5 cm - 3 ¹ / ₈ "x12 ³ / ₈ "	± 8,5 mm	Shiny



Marvel Porcelain Tiles / Gres Porcellanato

POLISHED SURFACE / SUPERFICIE LAPPATA

MARBLE LOOK



160x320 cm 63"x126"
A05U Marvel Calacatta Extra 160x320RT Lappato

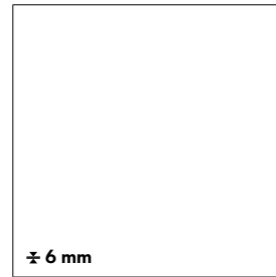

160x160 cm 63"x63"
A051 Marvel Calacatta Extra 160x160RT Lappato



120x278 cm 47 1/4"x109 1/2"
A08M Marvel Calacatta Extra Lappato
A0TJ Marvel Calacatta Extra Bookmatch A Lappato
A0TK Marvel Calacatta Extra Bookmatch B Lappato
A0QD Marvel Grey Stone Lappato
A0UB Marvel Calacatta Extra 120x278 Endless Lappato



120x240 cm 47 1/4"x94 1/2"
AY2N Marvel Calacatta Extra 120x240 Lappato
AY2O Marvel Grey Stone 120x240 Lappato

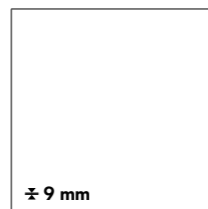

120x120 cm 47 1/4"x47 1/4"
AY2R Marvel Calacatta Extra 120x120 Lappato
AY2S Marvel Grey Stone 120x120 Lappato



60x120 cm 23 3/8"x47 1/4"
A21S Marvel Calacatta Extra 60x120 Lappato
A21H Marvel Grey Stone 60x120 Lappato

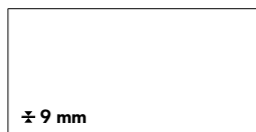

75x150 cm 29 1/2"x59"
AMSF Marvel Calacatta Extra 75x150 Lappato
A8K4 Marvel Grey Stone 75x150 Lappato
A8K3 Marvel Champagne Onyx 75x150 Lappato

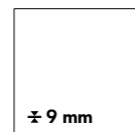

75x75 cm 29 1/2"x29 1/2"
ADPV Marvel Calacatta Extra 75 Lappato
ADPX Marvel Moon Onyx 75 Lappato
ADPY Marvel Grey Stone 75 Lappato
ADPW Marvel Champagne Onyx 75 Lappato
ADPT Marvel Beige Mystery 75 Lappato
ADPU Marvel Bronze Luxury 75 Lappato

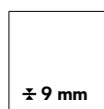

60x60 cm 23 3/8"x23 3/8"
7N30 Marvel Calacatta Extra 60 Lappato
7N3P Marvel Moon Onyx 60 Lappato
7N3T Marvel Grey Stone 60 Lappato
7N3Q Marvel Champagne Onyx 60 Lappato
7N3R Marvel Beige Mystery 60 Lappato
7N3S Marvel Bronze Luxury 60 Lappato

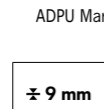

30x60 cm 11 3/4"x23 3/8"
D016 Marvel Calacatta Extra 30x60 Lappato
D017 Marvel Moon Onyx 30x60 Lappato
D021 Marvel Grey Stone 30x60 Lappato
D018 Marvel Champagne Onyx 30x60 Lappato
D019 Marvel Beige Mystery 30x60 Lappato
D020 Marvel Bronze Luxury 30x60 Lappato

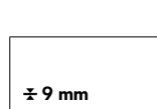

45x90 cm 17 3/4"x35 3/8"
ADRS Marvel Calacatta Extra 45x90 Lappato
AVWZ Marvel Moon Onyx 45x90 Lappato
ADSY Marvel Grey Stone 45x90 Lappato
AVVY Marvel Champagne Onyx 45x90 Lappato
AVWW Marvel Beige Mystery 45x90 Lappato
AVWX Marvel Bronze Luxury 45x90 Lappato



LAPPATO LUX
162x324 cm 63 3/4"x127 1/2"
> **NON RECTIFIED** / NON RETTIFICATO
AN1I Calacatta Extra A Lap Lux ± 6 mm
AN1J Calacatta Extra A Lap Lux ± 6 mm ST *
AAVM Calacatta Extra A Lap Lux ± 12 mm
AAVD Calacatta Extra A Lap Lux ± 12 mm ST *
AN1W Calacatta Extra A Lap Lux ± 20 mm
A00H Calacatta Extra B Lap Lux ± 6 mm
A00I Calacatta Extra B Lap Lux ± 6 mm ST *
AAVN Calacatta Extra B Lap Lux ± 12 mm
AAVF Calacatta Extra B Lap Lux ± 12 mm ST *
A00E Calacatta Extra B Lap Lux ± 20 mm
A0AY Calacatta Extra A Bookmatch Lap Lux ± 6 mm
A0AZ Calacatta Extra A Bookmatch Lap Lux ± 6 mm ST *
AA2W Calacatta Extra A Bookmatch Lap Lux ± 12 mm
AA2X Calacatta Extra A Bookmatch Lap Lux ± 12 mm ST *

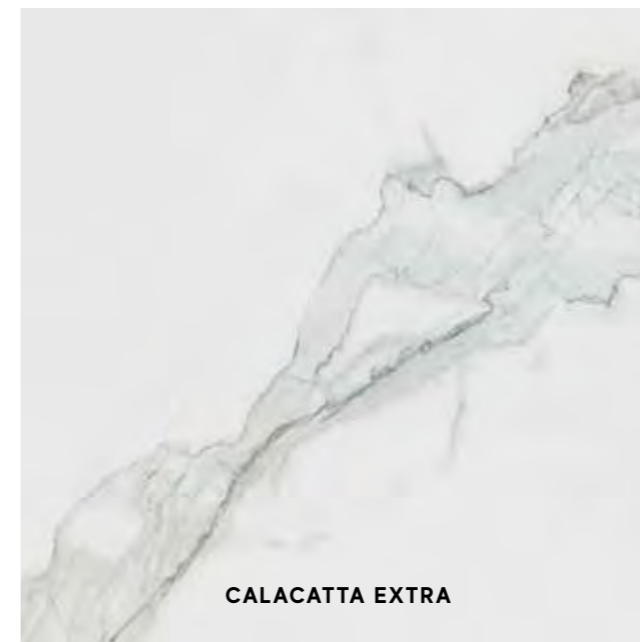

CALACATTA EXTRA



CHAMPAGNE ONYX



MOON ONYX

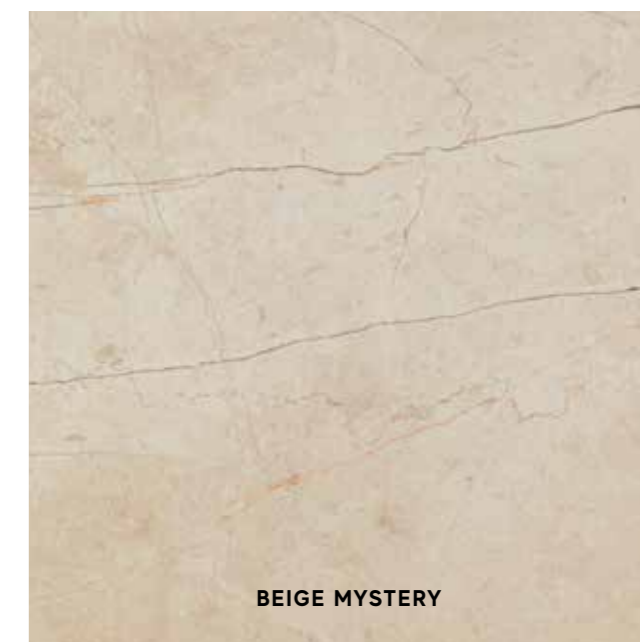

BEIGE MYSTERY

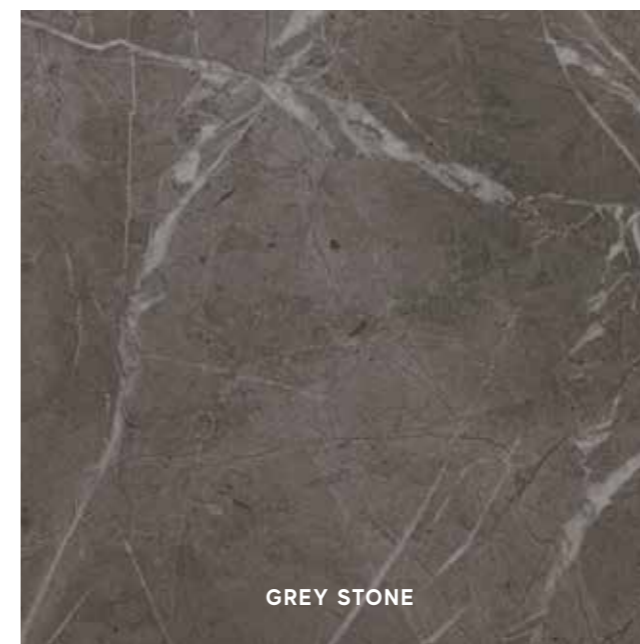

GREY STONE



BRONZE LUXURY



V2
SLIGHT
VARIATION

Calacatta Extra,
Moon Onyx,
Grey Stone,
Champagne Onyx,
Beige Mystery,
Bronze Luxury

The glossy polished finish is suitable for residential or low-traffic commercial floors, where no anti-slip performance is required, and for walls. The polished glossy surface finish, surprisingly brilliant and bright, features slight irregularities typical of natural marble. The extraordinary brilliance and the easy cleaning of the surface are the result of in-depth research aimed at guaranteeing its durability over time. - If the product is in direct contact with the outdoors, provide devices for absorbing moisture and dirt to prevent scratches. / La finitura lappata lucida è indicata per pavimenti residenziali o commerciali poco sollecitati, laddove non siano richieste prestazioni antiscivolo, e per rivestimenti. La finitura lappata lucida offre una superficie sorprendentemente brillante e specchiante, con lievi irregolarità tipiche dei marmi naturali. La straordinaria lucentezza e l'elevata pulibilità della superficie sono frutto di studi approfonditi e accurate ricerche tecniche volte a garantirne la persistenza nel tempo. - Se il prodotto è a diretto contatto con l'esterno, prevedere dei dispositivi di assorbimento dell'umidità e della sporcizia per prevenire la formazione di graffi.

POLISHED SURFACE | SUPERFICIE LAPPATA | Surface adouci | Geläppte Oberfläche | Superficie bruñido | Полиполированный поверхность

* **WITH FIBERGLASS MESH** | VERSIONE STUOIATA | Version à nattes | Ausführung mit Glasfasermatte | Versión con malla | С упрочнением из стекловолоконка
NON RECTIFIED | NON RETTIFICATO | Non rectifié | Nicht rektifiziert | No rectificada | Неретифицированные

MARBLE LOOK



Marvel Porcelain Tiles / Gres Porcellanato

MATTE SURFACE / SUPERFICIE MATT



160x320 cm 63"x126"
A05Y Marvel Calacatta Extra 160x320RT Matt

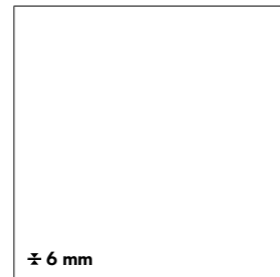

160x160 cm 63"x63"
A054 Marvel Calacatta Extra 160x160RT Matt



120x278 cm 47 1/4"x109 1/2"
A0BT Marvel Calacatta Extra 120x278 Matt
A2RP Marvel Grey Stone 120x278 Matt



- SILK**
162x324 cm 63 3/4"x127 1/2"
> **NON RECTIFIED / NON RETTIFICATO**
AN1H Calacatta Extra A Silk ± 6 mm
AN1G Calacatta Extra A Silk ± 6 mm ST *
AA2S Calacatta Extra A Silk ± 12 mm
AA2T Calacatta Extra A Silk ± 12 mm ST *
A0YC Calacatta Extra A Silk ± 20 mm
A00J Calacatta Extra B Silk ± 6 mm
A00K Calacatta Extra B Silk ± 6 mm ST *
AA3F Calacatta Extra B Silk ± 12 mm
AA3G Calacatta Extra B Silk ± 12 mm ST *
AOAV Calacatta Extra A Bookmatch Silk ± 6 mm
AOAW Calacatta Extra A Bookmatch Silk ± 6 mm ST *
AMJU Calacatta Extra A Bookmatch Silk ± 12 mm
AMJV Calacatta Extra A Bookmatch Silk ± 12 mm ST *
AN1U Grey Stone Silk ± 6 mm
AN1V Grey Stone Silk ± 6 mm ST *
AAVY Grey Stone Silk ± 12 mm
AAWA Grey Stone Silk ± 12 mm ST *
AN2B Grey Stone Silk ± 20 mm

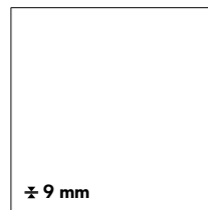

120x120 cm 47 1/4"x47 1/4"
A20Y Marvel Calacatta Extra 120x120 Matt
AEQY Marvel Grey Stone 120x120 Matt



60x120 cm 23 1/2"x47 1/4"
A208 Marvel Calacatta Extra 60x120 Matt
A209 Marvel Grey Stone 60x120 Matt



75x150 cm 29 1/2"x59"
AMGC Marvel Calacatta Extra 75x150

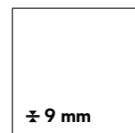

75x75 cm 29 1/2"x29 1/2"
ASCE Marvel Calacatta Extra 75
ASCF Marvel Moon Onyx 75
ASCJ Marvel Grey Stone 75
ASCG Marvel Champagne Onyx 75
ASCH Marvel Beige Mystery 75
ASCI Marvel Bronze Luxury 75

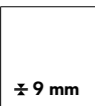

60x60 cm 23 5/8"x23 5/8"
7N3A Marvel Calacatta Extra 60
7N3B Marvel Moon Onyx 60
7N3F Marvel Grey Stone 60
7N3C Marvel Champagne Onyx 60
7N3D Marvel Beige Mystery 60
7N3E Marvel Bronze Luxury 60



30x60 cm 11 3/4"x23 5/8"
D095 Marvel Calacatta Extra 30x60
D096 Marvel Moon Onyx 30x60
D100 Marvel Grey Stone 30x60
D097 Marvel Champagne Onyx 30x60
D098 Marvel Beige Mystery 30x60
D099 Marvel Bronze Luxury 30x60



45x90 cm 17 3/4"x35 3/8"
ASFE Marvel Calacatta Extra 45x90
ASFG Marvel Moon Onyx 45x90
ASFJ Marvel Grey Stone 45x90
ASFF Marvel Champagne Onyx 45x90
ASFH Marvel Beige Mystery 45x90
ASFI Marvel Bronze Luxury 45x90

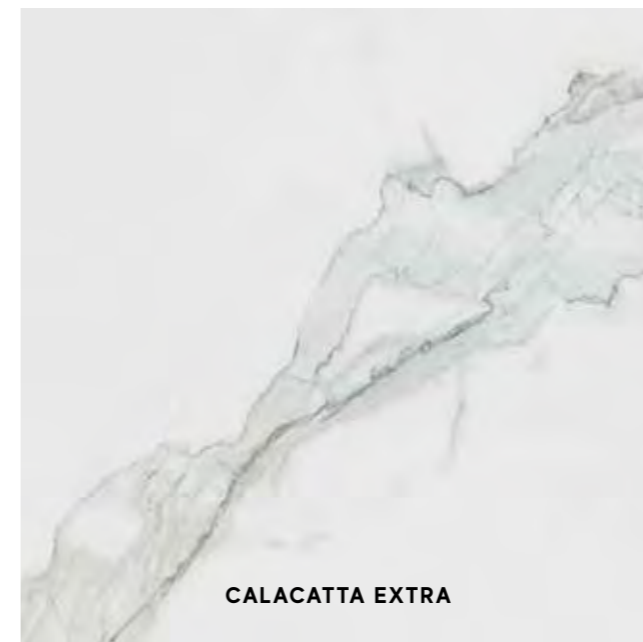

CALACATTA EXTRA



CHAMPAGNE ONYX



MOON ONYX

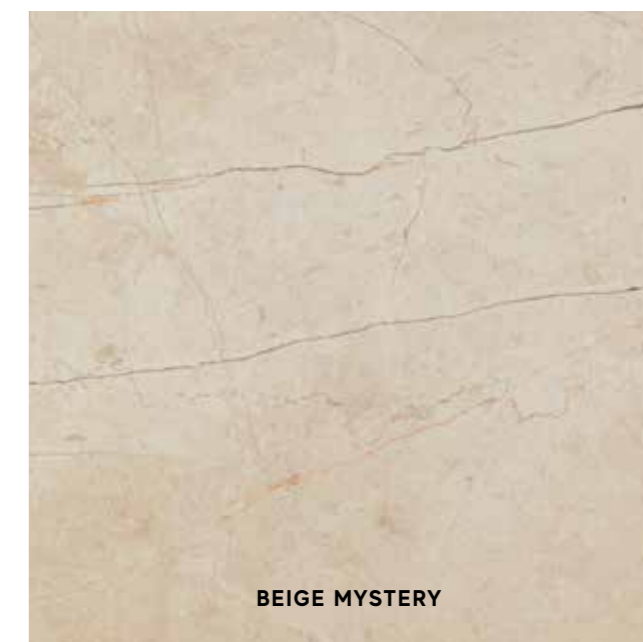

BEIGE MYSTERY

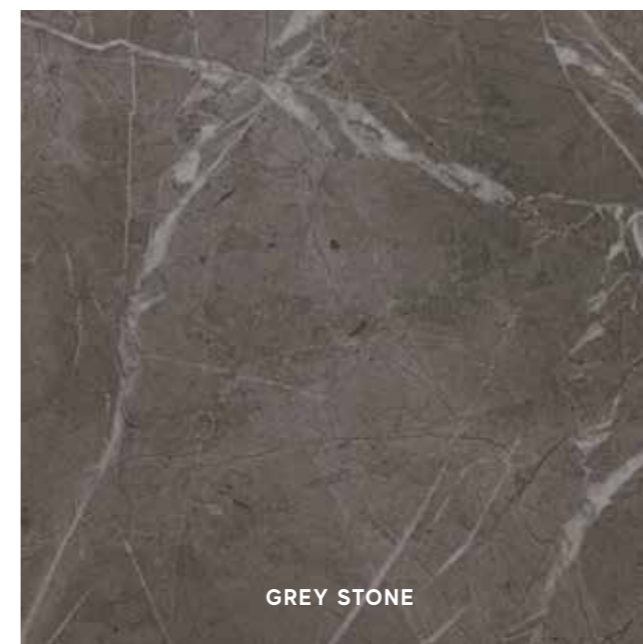

GREY STONE



BRONZE LUXURY



V2 SLIGHT VARIATION
Calacatta Extra,
Moon Onyx,
Grey Stone,
Champagne Onyx,
Beige Mystery,
Bronze Luxury

MATTE SURFACE | SUPERFICIE MATT | Surface Mat | Matt oberfläche | Superficie Mate | Матовая поверхность

* WITH FIBERGLASS MESH | VERSIONE STUOIATA | Version à nattes | Ausführung mit Glasfasermatte | Version con malla | С упрочнением из стекловолоконна
NON RECTIFIED | NON RETTIFICATO | Non rectifié | Nicht rektifiziert | No rectificada | Неретифицированные

Marvel Porcelain Tiles / Gres Porcellanato

DECOR RANGE / GAMMA DECORI

MARBLE LOOK

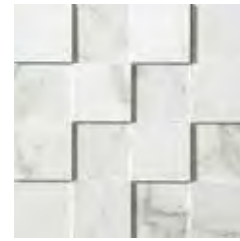

ASLC Marvel Calacatta Mosaico 3D *
30x30 - 11³/₄"x11³/₄"

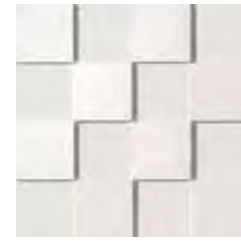

ASLD Marvel Moon Mosaico 3D *
30x30 - 11³/₄"x11³/₄"

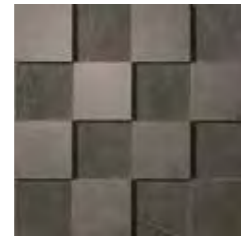

ASLH Marvel Grey Mosaico 3D *
30x30 - 11³/₄"x11³/₄"



ASLE Marvel Champagne Mosaico 3D *
30x30 - 11³/₄"x11³/₄"



ASLF Marvel Beige Mosaico 3D *
30x30 - 11³/₄"x11³/₄"



ASLG Marvel Bronze Mosaico 3D *
30x30 - 11³/₄"x11³/₄"

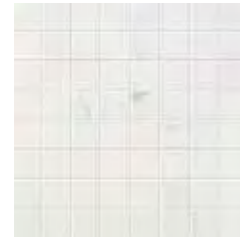

ASK5 Marvel Calacatta Mosaico Matt
30x30 - 11³/₄"x11³/₄"

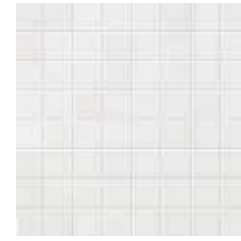

ASK6 Marvel Moon Mosaico Matt
30x30 - 11³/₄"x11³/₄"

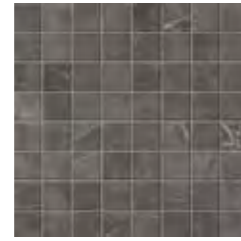

ASLA Marvel Grey Mosaico Matt
30x30 - 11³/₄"x11³/₄"

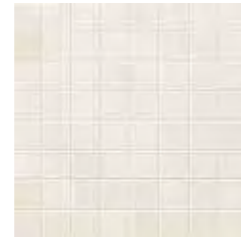

ASK7 Marvel Champagne Mosaico Matt
30x30 - 11³/₄"x11³/₄"



ASK8 Marvel Beige Mosaico Matt
30x30 - 11³/₄"x11³/₄"



ASK9 Marvel Bronze Mosaico Matt
30x30 - 11³/₄"x11³/₄"



ASMB Marvel Calacatta Mosaico Lappato
30x30 - 11³/₄"x11³/₄"

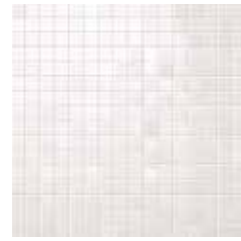

ASMC Marvel Moon Mosaico Lappato
30x30 - 11³/₄"x11³/₄"

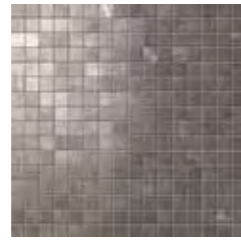

ASMG Marvel Grey Mosaico Lappato
30x30 - 11³/₄"x11³/₄"



ASMD Marvel Champagne Mosaico Lappato
30x30 - 11³/₄"x11³/₄"



ASME Marvel Beige Mosaico Lappato
30x30 - 11³/₄"x11³/₄"



ASMF Marvel Bronze Mosaico Lappato
30x30 - 11³/₄"x11³/₄"



ASM9 Marvel Grey/Moon Greca Mosaico
18,5x30 - 7¹/₄"x11³/₄"



ASNB Marvel Grey/Moon Angolo Mosaico
18,5x18,5 - 7¹/₄"x 7¹/₄"



ASM8 Marvel Bronze/Champagne Greca Mosaico
18,5x30 - 7¹/₄"x11³/₄"

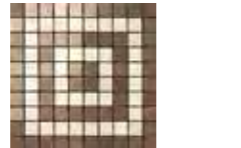

ASNA Marvel Bronze/Champagne Angolo Mosaico
18,5x18,5 - 7¹/₄"x 7¹/₄"

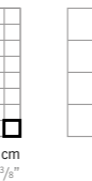
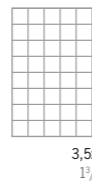
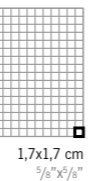
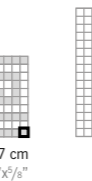
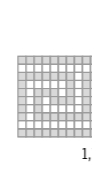
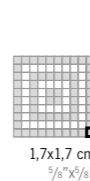

• **MULTI-THICKNESS MOSAIC, CLOSE JOINT INSTALLATION WITHOUT GROUTING.**
 MOSAICO MULTISPESORE, POSA SENZA STUCCATURA A GIUNTO UNITO.
 Mosaïque multi-épaisseur, pose sans mastic avec joint nul.
 Mosaik mit verschiedenen Stärken, fugenlose Verlegung ohne Mörtel.
 Mosaico multiespesor, colocación sin mástico y sin juntas.
 Мозаика разной толщины; укладка встык без затирки швов.

THE DECORATION CAN ONLY BE LAID ON THE WALL | IL DECORO SI PUÒ POSARE SOLO A RIVESTIMENTO
 Décor uniquement mural | Das Dekor kann nur an der Wand verlegt werden | La decoración se puede colocar únicamente en paredes | Декор может быть уложен только на стену.



AVXF Marvel Calacatta Listello 7x75 Lappato
7x75 - 2³/₄"x29¹/₂"



AVXG Marvel Moon Listello 7x75 Lappato
7x75 - 2³/₄"x29¹/₂"



AVXK Marvel Grey Listello 7x75 Lappato
7x75 - 2³/₄"x29¹/₂"



AVXH Marvel Champagne Listello 7x75 Lappato
7x75 - 2³/₄"x29¹/₂"



AVXJ Marvel Beige Listello 7x75 Lappato
7x75 - 2³/₄"x29¹/₂"



AVXI Marvel Bronze Listello 7x75 Lappato
7x75 - 2³/₄"x29¹/₂"



AVXL Marvel Calacatta Listello Esagono Lappato
11x86 - 4³/₈"x33⁷/₈"

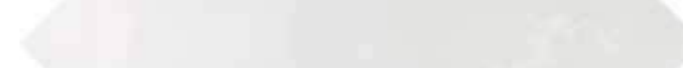

AVXM Marvel Champagne Listello Esagono Lappato
11x86 - 4³/₈"x33⁷/₈"



AVXN Marvel Moon Listello Esagono Lappato
11x86 - 4³/₈"x33⁷/₈"



AVXQ Marvel Grey Listello Esagono Lappato
11x86 - 4³/₈"x33⁷/₈"

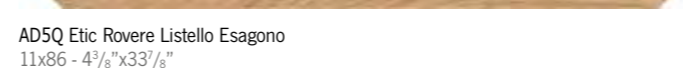

AVXP Marvel Bronze Listello Esagono Lappato
11x86 - 4³/₈"x33⁷/₈"



AD5Q Etic Rovere Listello Esagono
11x86 - 4³/₈"x33⁷/₈"



AD5R Etic Noce Listello Esagono
11x86 - 4³/₈"x33⁷/₈"



AD3J Etic Listello Palissandro Esagono
11x86 - 4³/₈"x33⁷/₈"



AVXB Marvel Calacatta Listello 7x60 Lappato
7x60 - 2³/₄"x23⁵/₈"



AVXC Marvel Moon Listello 7x60 Lappato
7x60 - 2³/₄"x23⁵/₈"



AVXE Marvel Grey Listello 7x60 Lappato
7x60 - 2³/₄"x23⁵/₈"



AE3W Marvel Champagne Listello 7x60 Lappato
7x60 - 2³/₄"x23⁵/₈"



AVXD Marvel Beige Listello 7x60 Lappato
7x60 - 2³/₄"x23⁵/₈"



AE3X Marvel Bronze Listello 7x60 Lappato
7x60 - 2³/₄"x23⁵/₈"



AVXM Marvel Champagne Listello Esagono Lappato
11x86 - 4³/₈"x33⁷/₈"



AVXO Marvel Beige Listello Esagono Lappato
11x86 - 4³/₈"x33⁷/₈"

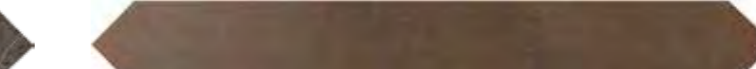

AVXP Marvel Bronze Listello Esagono Lappato
11x86 - 4³/₈"x33⁷/₈"



AD5P Etic Rovere Bianco Listello Esagono
11x86 - 4³/₈"x33⁷/₈"

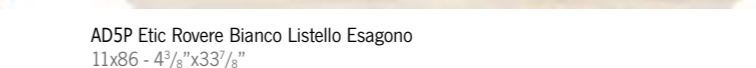

AD5S Etic Ebanò Listello Esagono
11x86 - 4³/₈"x33⁷/₈"

MARBLE LOOK

Marvel Porcelain Tiles / Gres Porcellanato

DECOR RANGE / GAMMA DECORI

MARBLE LOOK



D013 Marvel Calacatta Broccato
30x60 - 11³/₄"x23⁵/₈"



D014 Marvel Champagne Broccato
30x60 - 11³/₄"x23⁵/₈"



D015 Marvel Bronze Broccato
30x60 - 11³/₄"x23⁵/₈"



ASL5 Marvel Calacatta Cassettoni Lappato
45x45 - 17³/₄"x17³/₄"



ASL6 Marvel Moon Cassettoni Lappato
45x45 - 17³/₄"x17³/₄"



ASMA Marvel Grey Cassettoni Lappato
45x45 - 17³/₄"x17³/₄"

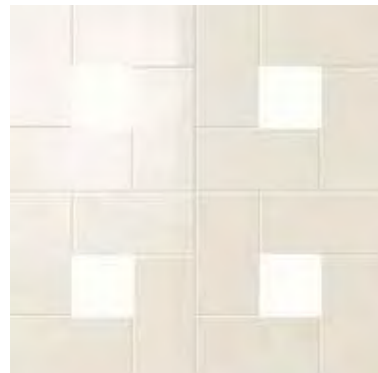

ASL7 Marvel Champagne Cassettoni Lappato
45x45 - 17³/₄"x17³/₄"



ASL8 Marvel Beige Cassettoni Lappato
45x45 - 17³/₄"x17³/₄"



ASL9 Marvel Bronze Cassettoni Lappato
45x45 - 17³/₄"x17³/₄"



ASJ3 Marvel Calacatta Angolo 7x7 Lappato
7x7 - 2³/₄"x2³/₄"



ASJ4 Marvel Moon Angolo 7x7 Lappato
7x7 - 2³/₄"x2³/₄"



ASJ8 Marvel Grey Angolo 7x7 Lappato
7x7 - 2³/₄"x2³/₄"



ASJ5 Marvel Champagne Angolo 7x7 Lappato
7x7 - 2³/₄"x2³/₄"



ASJ6 Marvel Beige Angolo 7x7 Lappato
7x7 - 2³/₄"x2³/₄"



ASJ7 Marvel Bronze Angolo 7x7 Lappato
7x7 - 2³/₄"x2³/₄"

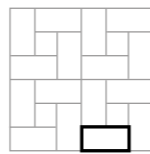

14,5x7,4 cm
5³/₄"x2³/₈"



ADQ2 Marvel Statuario Select Angolo 7x7 Lappato
7x7 - 2³/₄"x2³/₄"



ADQ6 Marvel Grey Fleury Angolo 7x7 Lappato
7x7 - 2³/₄"x2³/₄"



ADQ7 Marvel Noir St. Laurent Angolo 7x7 Lappato
7x7 - 2³/₄"x2³/₄"



ADQ4 Marvel Crema Delicato Angolo 7x7 Lappato
7x7 - 2³/₄"x2³/₄"



ADQ3 Marvel Travertino Alabastrino Angolo 7x7 Lappato
7x7 - 2³/₄"x2³/₄"



ADQ5 Marvel Travertino Silver Angolo 7x7 Lappato
7x7 - 2³/₄"x2³/₄"



AM8R Etic Rovere Bottone 7x7
7x7 - 2³/₄"x2³/₄"



AM8T Etic Noce Bottone 7x7
7x7 - 2³/₄"x2³/₄"



AM8V Etic Palissandro Bottone 7x7
7x7 - 2³/₄"x2³/₄"



AM8S Etic Ulivo Bottone 7x7
7x7 - 2³/₄"x2³/₄"



AM8Q Etic Rovere Bianco Bottone 7x7
7x7 - 2³/₄"x2³/₄"



AM8U Etic Rovere Grigio Bottone 7x7
7x7 - 2³/₄"x2³/₄"



AM8W Etic Ebano Bottone 7x7
7x7 - 2³/₄"x2³/₄"



AVW7 Marvel Glitter Rosone Angolo **
60x60 - 23⁵/₈"x23⁵/₈"



AVW4 Marvel Elegance Angolo Warm •
60x60 - 23⁵/₈"x23⁵/₈"



AVW6 Marvel Elegance Fascia Warm
60x60 - 23⁵/₈"x23⁵/₈"



AVW8 Marvel Glitter Fascia 7x60
7x60 - 2³/₄"x23⁵/₈"



ASNQ Marvel Glitter Bottone 7x7
7x7 - 2³/₄"x2³/₄"

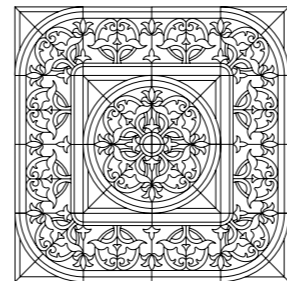
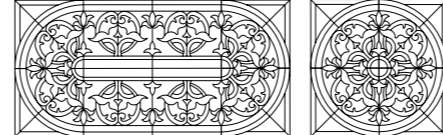

Elegance Warm
Bronze + Beige + Champagne + Calacatta

Elegance Cold
Grey + Calacatta + Moon + Beige

• **MINIMUM ORDER 2 PEZZI.**
ORDINE MINIMO 2 PEZZI.
Commande minimum 2 pièces.
Mindestbestellmenge 2 Stück.
Pedido mínimo 2 unidades.
Минимальный заказ – 2 шт.

•• **MINIMUM ORDER 4 PEZZI.**
ORDINE MINIMO 4 PEZZI.
Commande minimum 4 pièces.
Mindestbestellmenge 4 Stück.
Pedido mínimo 4 unidades.
Минимальный заказ – 4 шт.

TRIM TILES / PEZZI SPECIALI

p. 424

	Battiscopa 7,2x60 2 ⁷ / ₈ "x23 ⁵ / ₈ "	Battiscopa Lappato 7,2x60 2 ⁷ / ₈ "x23 ⁵ / ₈ "	Gradino • 30x60 11 ³ / ₄ "x23 ⁵ / ₈ "	Scalino • 33x90 13"x35 ⁵ / ₈ "	Scalino • 33x75 13"x29 ¹ / ₂ "	Scalino • 33x60 13"x23 ⁵ / ₈ "	Scalino Angolare • 33x33 13"x13"	Battiscopa Sag. Scala 7,2x30 - 2 ⁷ / ₈ "x11 ³ / ₄ "	
								DX •	SX •
Calacatta Extra	ASLJ	AVXS	ASLQ	ASMH	ASMZ	ASMN	ASMT	ASNC	ASNI
Moon Onyx	ASLK	AVXT	ASLR	ASMI	ASMØ	ASMO	ASMU	ASND	ASNJ
Champagne Onyx	ASLL	AVXU	ASLS	ASMJ	ASM1	ASMP	ASMV	ASNE	ASNK
Beige Mystery	ASLM	AVXV	ASLT	ASMK	ASM2	ASMQ	ASMW	ASNF	ASNL
Bronze Luxury	ASLN	AVXW	ASLU	ASML	ASM5	ASMR	ASMX	ASNG	ASNM
Grey Stone	ASLO	AVXX	ASLV	ASMM	ASM7	ASMS	ASMY	ASNH	ASNN

• THESE PARTS ARE SUPPLIED TO ORDER | I PEZZI SONO DISPONIBILI SU ORDINAZIONE | Les pièces sont disponibles sur commande | Die Teile sind auf Bestellung lieferbar | Las piezas se hacen por encargo | Изготавливаются на заказ

UPEC p. 571





Marvel Wall Tiles / Rivestimento

WALL TILES p. 494

SHINY SURFACE / SUPERFICIE LUCIDA

± 8,5 mm

50x110 cm 19³/₄"x43¹/₂"
4MPC Marvel Calacatta Extra 50x110
4MPV Marvel Silver Dream 50x110
4MPH Marvel Champagne Onyx 50x110

± 8,5 mm

40x80 cm 15³/₄"x31¹/₂"
8MVA Marvel Calacatta Extra 40x80
8MVS Marvel Silver Dream 40x80
8MVC Marvel Champagne Onyx 40x80

± 8,5 mm

30,5x91,5 cm 12"x36"
AR5J Marvel Calacatta Extra 30,5x91,5
AR5L Marvel Moon Onyx 30,5x91,5
AR5N Marvel Silver Dream 30,5x91,5
AR5K Marvel Champagne Onyx 30,5x91,5
AR5M Marvel Beige Mystery 30,5x91,5
AR5O Marvel Bronze Luxury 30,5x91,5

± 8,5 mm

30,5x56 cm 12"x22"
9P5L Marvel Calacatta Extra 30,5x56
9P5M Marvel Moon Onyx 30,5x56
9P5S Marvel Silver Dream 30,5x56
9P5H Marvel Champagne Onyx 30,5x56
9P5E Marvel Beige Mystery 30,5x56
9P5O Marvel Bronze Luxury 30,5x56

± 8,5 mm

8x31,5 cm 3¹/₈"x12³/₈"
LMKC Marvel Calacatta Extra Brick
LMKS Marvel Silver Dream Brick

DECORATIVE RANGE / GAMMA DECORATIVA



MOSAIC

GOLD MOSAIC

NET MOSAIC

LINE

BROCADE

WALLPAPER

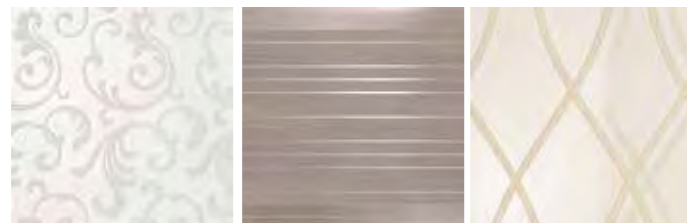

DAMASK

STRIPE

WAVE



SHINY SURFACE | SUPERFICIE LUCIDA | Surface brillante | Glänzende oberfläche | Superficie brillante | Глянec поверхность

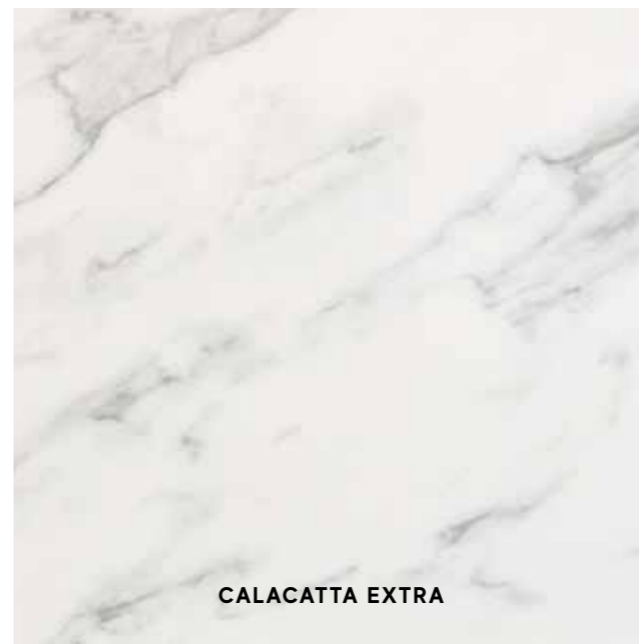

CALACATTA EXTRA



CHAMPAGNE ONYX



MOON ONYX



BEIGE MYSTERY



SILVER DREAM



BRONZE LUXURY



V2 SLIGHT VARIATION

Calacatta Extra,
Moon Onyx,
Silver Dream,
Champagne Onyx,
Beige Mystery,
Bronze Luxury



atlas concorde

MARVEL
DREAM
PORCELAIN & WALL TILES

Porcelain tiles / Gres Porcellanato

COLOURED BODY PORCELAIN TILES - RECTIFIED MONOCALIBER
GRES PORCELLANATO COLORATO IN MASSA - RETTIFICATO MONOCALIBRO

LARGE SIZES p. 366

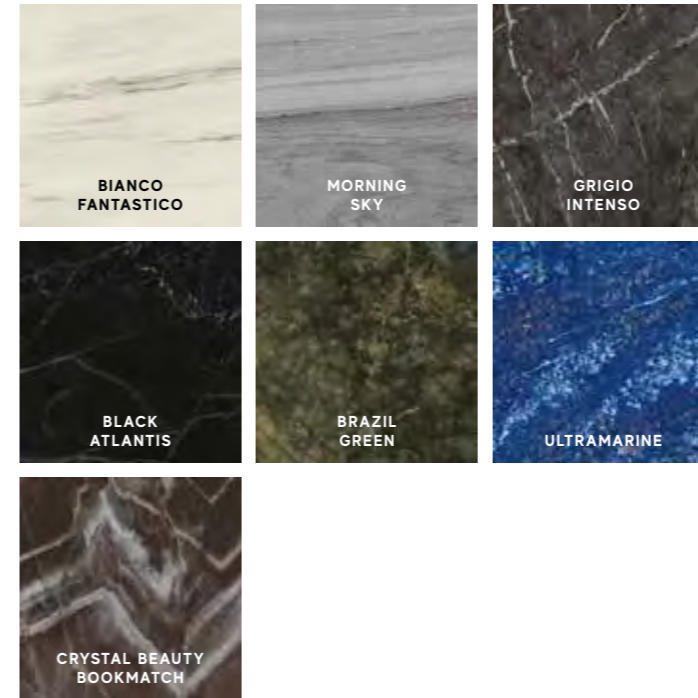

Sizes	Thickness	Surface finish
162x324 cm - 63 ³ / ₄ "x127 ¹ / ₂ " * NON RECTIFIED - NON RETTIFICATO	± 12 mm	Lappato Lux
120x278 cm - 47 ¹ / ₄ "x109 ¹ / ₂ "	± 6 mm	Polished, Matte R9 A
120x240 cm - 47 ¹ / ₄ "x94 ¹ / ₂ "	± 9 mm	Polished
120x120 cm - 47 ¹ / ₄ "x47 ¹ / ₄ "	± 9 mm	Polished, Matte R9 A
60x120 cm - 23 ⁵ / ₈ "x47 ¹ / ₄ "	± 9 mm	Polished, Matte R9 A
75x150 cm - 29 ¹ / ₂ "x59"	± 9 mm	Polished, Matte R9 A
75x75 cm - 29 ¹ / ₂ "x29 ¹ / ₂ "	± 9 mm	Polished, Matte R9 A
37,5x75 cm - 14 ³ / ₄ "x29 ¹ / ₂ "	± 9 mm	Polished, Matte R9 A
60x60 cm - 23 ⁵ / ₈ "x23 ⁵ / ₈ "	± 9 mm	Polished, Matte R10 A+B SOFT GRIP

Wall tiles / Rivestimento p. 502

WHITEBODY WALL TILES - RECTIFIED MONOCALIBER
RIVESTIMENTI IN PASTA BIANCA - RETTIFICATO MONOCALIBRO

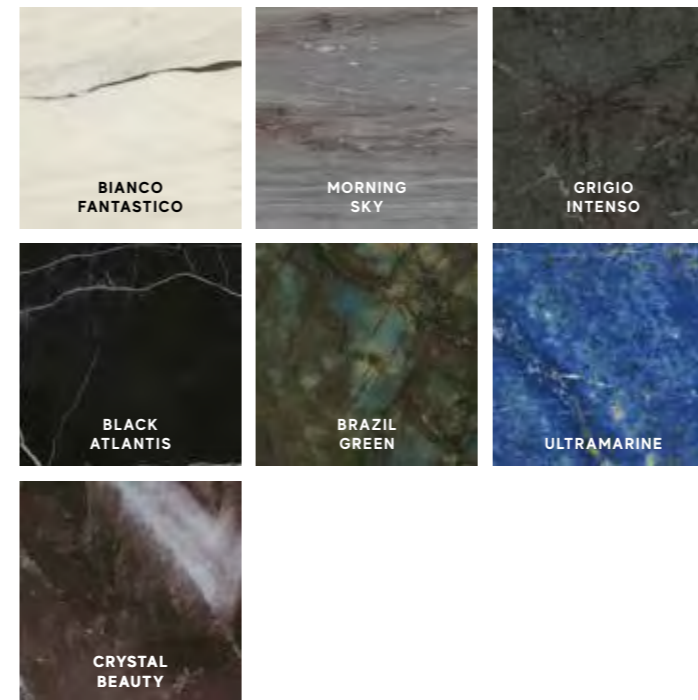

Sizes	Thickness	Surface finish
50x110 cm - 19 ⁵ / ₈ "x43 ¹ / ₄ "	± 8,5 mm	Shiny

COLOURED BODY PORCELAIN TILES | GRES PORCELLANATO COLORATO IN MASSA | Grés cérame coloré dans la masse | Durchgefärbtes Feinsteinzeug | Gres porcelánico coloreado en masa | Керамический гранит окрашенный в массе
WHITEBODY WALL TILES | RIVESTIMENTI IN PASTA BIANCA | Revêtements en pâte blanche | Weißscherbige Wandfliesen | Revestimientos en pasta blanca | Настенная плитка из белой глины
RECTIFIED MONOCALIBER | RETTIFICATO MONOCALIBRO | Rectifié mono-calibre | Geschliffen einkalibrig | Rectificado monocalibre | Ретифицированный в одном калибре
NON RECTIFIED | NON RETTIFICATO | Non rectifié | Nicht rektifiziert | No rectificada | Неретифицированные



Marvel Dream Porcelain Tiles / Gres Porcellanato

POLISHED SURFACE / SUPERFICIE LAPPATA



120x278 cm 47 1/4" x 109 1/2"

AOSE Marvel Bianco Fantastico 120x278 Lappato
AOSF Marvel Grigio Intenso 120x278 Lappato
AOSG Marvel Black Atlantis 120x278 Lappato
AL2I Marvel Ultramarine 120x278 Lappato *

atlasPLAN p. 366



LAPPATO LUX

162x324 cm 63 3/4" x 127 1/2"

> **NON RECTIFIED / NON RETTIFICATO**

AL90 Grigio Intenso Lappato Lux ± 12 mm

AL91 Grigio Intenso Lappato Lux ± 12 mm ST *



120x240 cm 47 1/4" x 94 1/2"

A03P Marvel Bianco Fantastico 120x240 Lappato
A03Q Marvel Grigio Intenso 120x240 Lappato
A03R Marvel Black Atlantis 120x240 Lappato

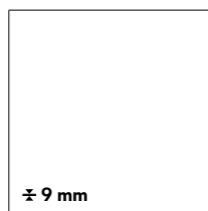

120x120 cm 47 1/4" x 47 1/4"

AL7N Marvel Bianco Fantastico 120x120 Lappato
AL7O Marvel Grigio Intenso 120x120 Lappato
AL7P Marvel Black Atlantis 120x120 Lappato



60x120 cm 23 5/8" x 47 1/4"

A21J Marvel Bianco Fantastico 60x120 Lappato
A21I Marvel Black Atlantis 60x120 Lappato

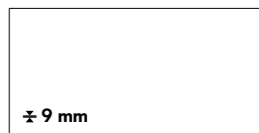

75x150 cm 29 1/2" x 59"

AORS Marvel Bianco Fantastico 75x150 Lappato
AORU Marvel Grigio Intenso 75x150 Lappato
AORT Marvel Morning Sky 75x150 Lappato
AORV Marvel Black Atlantis 75x150 Lappato
AL2D Marvel Ultramarine 75x150 Lappato
AL2E Marvel Brazil Green 75x150 Lappato
AL2C Marvel Crystal Beauty 75x150 Lap. Book. A
AOUF Marvel Crystal Beauty 75x150 Lap. Book. B

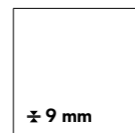

75x75 cm 29 1/2" x 29 1/2"

AORW Marvel Bianco Fantastico 75x75 Lappato
AORY Marvel Grigio Intenso 75x75 Lappato
AORX Marvel Morning Sky 75x75 Lappato
AORZ Marvel Black Atlantis 75x75 Lappato
AL2G Marvel Ultramarine 75x75 Lappato
AL2H Marvel Brazil Green 75x75 Lappato

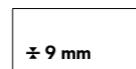

37,5x75 cm 14 9/16" x 29 1/2"

AOR8 Marvel Bianco Fantastico 37,5x75 Lappato
AOSA Marvel Grigio Intenso 37,5x75 Lappato
AOR9 Marvel Morning Sky 37,5x75 Lappato
AOSD Marvel Black Atlantis 37,5x75 Lappato

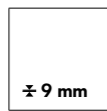

60x60 cm 23 5/8" x 23 5/8"

AL2N Marvel Bianco Fantastico 60x60 Lappato
AL7L Marvel Grigio Intenso 60x60 Lappato
AL2O Marvel Morning Sky 60x60 Lappato
AL7M Marvel Black Atlantis 60x60 Lappato

* **ULTRAMARINE 120x278 cm: GLAZED PORCELAIN TILES** / ULTRAMARINE 120x278 cm: GRES PORCELLANATO SMALTATO / Ultramarine 120x278 cm: carreaux en grès cérame émaillé / Ultramarine 120x278 cm: glasierte Feinsteinzeugfliesen / Ultramarine 120x278 cm: mosaico de gres porcelánico esmaltado / Ultramarine 120x278 cm: глазурованный керамогранит.

The glossy polished finish is suitable for residential or low-traffic commercial floors, where no anti-slip performance is required, and for walls. The polished glossy surface finish, surprisingly brilliant and bright, features slight irregularities typical of natural marble. The extraordinary brilliance and the easy cleaning of the surface are the result of in-depth research aimed at guaranteeing its durability over time. If the product is in direct contact with the outdoors, provide devices for absorbing moisture and dirt to prevent scratches. / La finitura lappata lucida è indicata per pavimenti residenziali o commerciali poco sollecitati, laddove non siano richieste prestazioni antiscivolo, e per rivestimenti. La finitura lappata lucida offre una superficie sorprendentemente brillante e specchiante, con lievi irregolarità tipiche dei marmi naturali. La straordinaria lucentezza e l'elevata pulibilità della superficie sono frutto di studi approfonditi e accurate ricerche tecniche volte a garantirne la persistenza nel tempo. Se il prodotto è a diretto contatto con l'esterno, prevedere dei dispositivi di assorbimento dell'umidità e della sporcizia per prevenire la formazione di graffi.

POLISHED SURFACE | SUPERFICIE LAPPATA | Surface adouci | Geläppt oberfläche | Superficie brufiido | Полуполированный поверхность

* **WITH FIBERGLASS MESH** | VERSIONE STUOIATA | Version à nattes | Ausführung mit Glasfasermatte | Versión con malla | С упрочнением из стекловолокна
NON RECTIFIED | NON RETTIFICATO | Non rectifié | Nicht rektifiziert | No rectificada | Неретицированные



BIANCO FANTASTICO



MORNING SKY



GRIGIO INTENSO

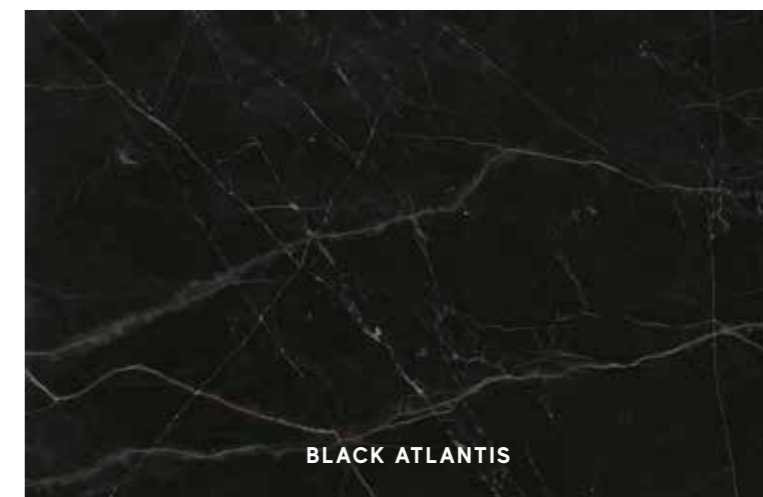

BLACK ATLANTIS



BRAZIL GREEN

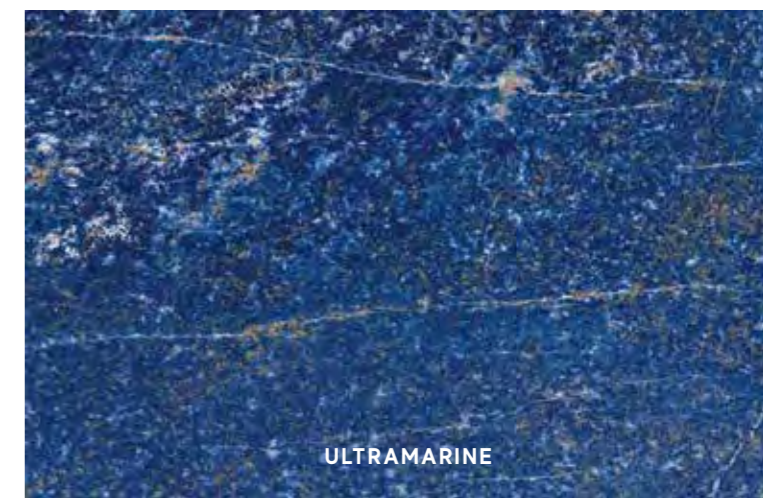

ULTRAMARINE

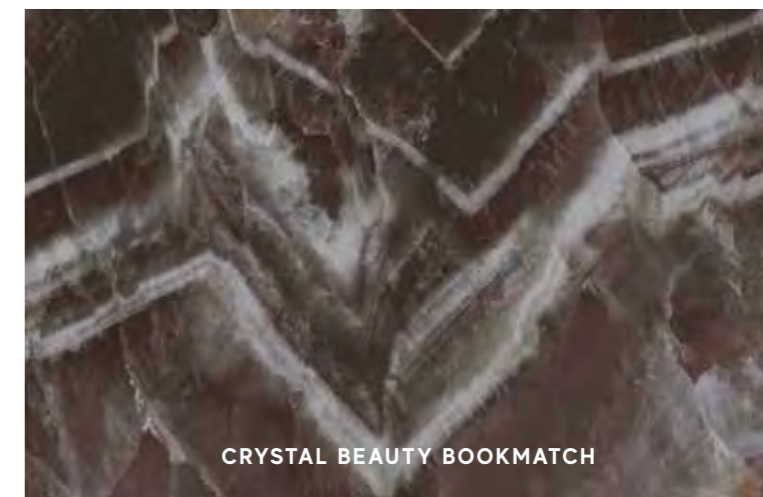

CRYSTAL BEAUTY BOOKMATCH



V3 MODERATE VARIATION
Brazil Green,
Morning Sky,
Ultramarine



V2 SLIGHT VARIATION
Bianco Fantastico,
Grigio Intenso,
Crystal Beauty,
Black Atlantis



Marvel Dream Porcelain Tiles / Gres Porcellanato

MATTE SURFACE / SUPERFICIE MATT



120x278 cm 47 1/4" x 109 1/2"
A2RR Marvel Bianco Fantastico 120x278 Matt
A2RQ Marvel Black Atlantis 120x278 Matt

atlasPLAN p. 366



SILK
162x324 cm 63 3/4" x 127 1/2"
> **NON RECTIFIED / NON RETTIFICATO**
A2YC Grigio Intenso Silk ± 6 mm
A2YI Grigio Intenso Silk ± 6 mm ST *
A0Y8 Grigio Intenso Silk ± 12 mm
A0Y9 Grigio Intenso Silk ± 12 mm ST *



BIANCO FANTASTICO



MORNING SKY

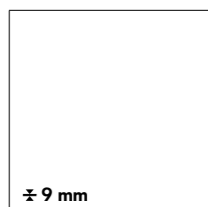

120x120 cm 47 1/4" x 47 1/4"
A203 Marvel Bianco Fantastico 120x120 Matt
A20Z Marvel Black Atlantis 120x120 Matt

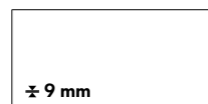

60x120 cm 23 5/8" x 47 1/4"
A21B Marvel Bianco Fantastico 60x120 Matt
A21A Marvel Black Atlantis 60x120 Matt

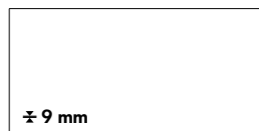

75x150 cm 29 1/2" x 59"
AOR0 Marvel Bianco Fantastico 75x150 Matt
AOR2 Marvel Grigio Intenso 75x150 Matt
AOR1 Marvel Morning Sky 75x150 Matt
AOR3 Marvel Black Atlantis 75x150 Matt

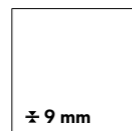

75x75 cm 29 1/2" x 29 1/2"
AOR4 Marvel Bianco Fantastico 75x75 Matt
AOR6 Marvel Grigio Intenso 75x75 Matt
AOR5 Marvel Morning Sky 75x75 Matt
AOR7 Marvel Black Atlantis 75x75 Matt

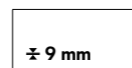

37,5x75 cm 14 3/4" x 29 1/2"
AOSH Marvel Bianco Fantastico 37,5x75 Matt
AOSJ Marvel Grigio Intenso 37,5x75 Matt
AOSI Marvel Morning Sky 37,5x75 Matt
AOSK Marvel Black Atlantis 37,5x75 Matt

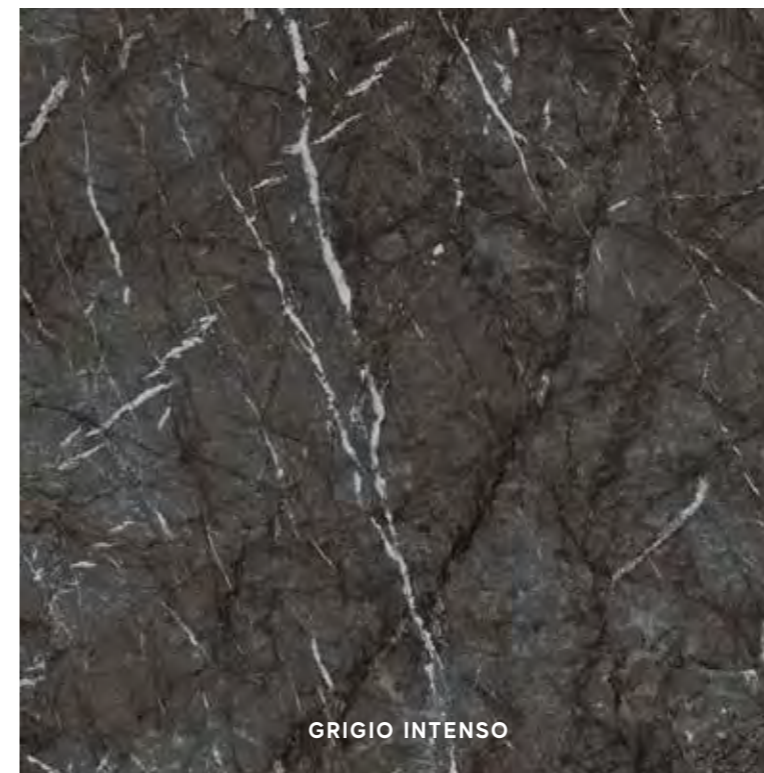

GRIGIO INTENSO



BLACK ATLANTIS

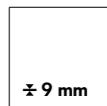

60x60 cm 23 5/8" x 23 5/8"
AL2J Marvel Bianco Fantastico 60x60 Matt
AL2L Marvel Grigio Intenso 60x60 Matt
AL2K Marvel Morning Sky 60x60 Matt
AL2M Marvel Black Atlantis 60x60 Matt

MATTE SURFACE | SUPERFICIE MATT | Surface Mat | Matt oberfläche | Superficie Mate | Матовая поверхность

* WITH FIBERGLASS MESH | VERSIONE STUOIATA | Version à nattes | Ausführung mit Glasfasermatte | Versión con malla | С упрочнением из стекловолокна
NON RECTIFIED | NON RETTIFICATO | Non rectifié | Nicht rektifiziert | No rectificada | Неретифицированные



V2
SLIGHT
VARIATION

Bianco Fantastico,
Grigio Intenso,
Crystal Beauty,
Black Atlantis

Marvel Dream Porcelain Tiles / Gres Porcellanato

DECOR RANGE / GAMMA DECORI

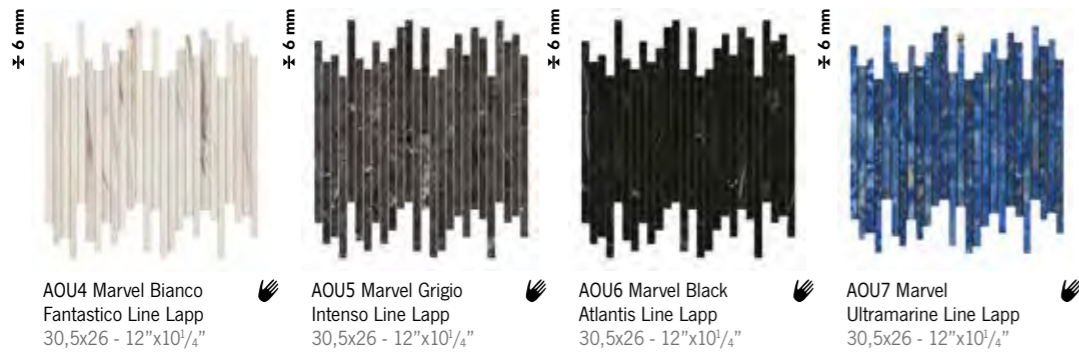

AOU4 Marvel Bianco Fantastico Line Lapp 30,5x26 - 12"x10³/₄"
AOU5 Marvel Grigio Intenso Line Lapp 30,5x26 - 12"x10³/₄"
AOU6 Marvel Black Atlantis Line Lapp 30,5x26 - 12"x10³/₄"
AOU7 Marvel Ultramarine Line Lapp 30,5x26 - 12"x10³/₄"

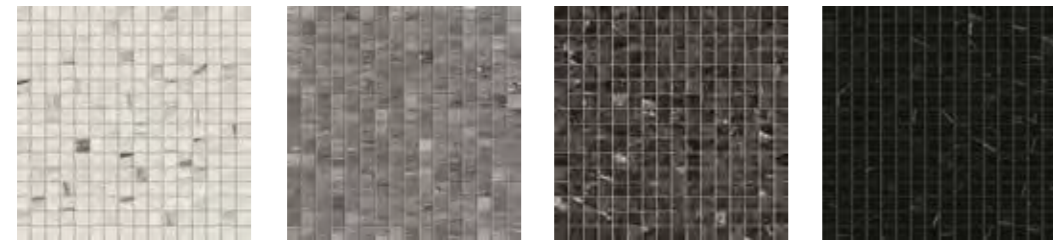
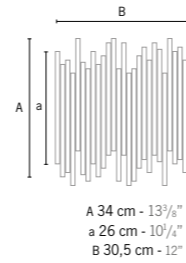

AOU8 Marvel Bianco Fantastico Mosaico Lappato 30x30 - 11³/₄"x11³/₄"
AOU9 Marvel Morning Sky Mosaico Lappato 30x30 - 11³/₄"x11³/₄"
AOUA Marvel Grigio Intenso Mosaico Lappato 30x30 - 11³/₄"x11³/₄"
AOVB Marvel Black Atlantis Mosaico Lappato 30x30 - 11³/₄"x11³/₄"

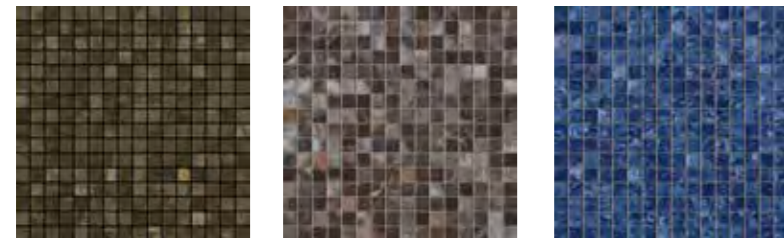
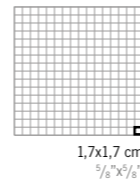

AOVE Marvel Brazil Green Mosaico Lappato 30x30 - 11³/₄"x11³/₄"
AOVC Marvel Crystal Beauty Mosaico Lappato 30x30 - 11³/₄"x11³/₄"
AOVD Marvel Ultramarine Mosaico Lappato 30x30 - 11³/₄"x11³/₄"

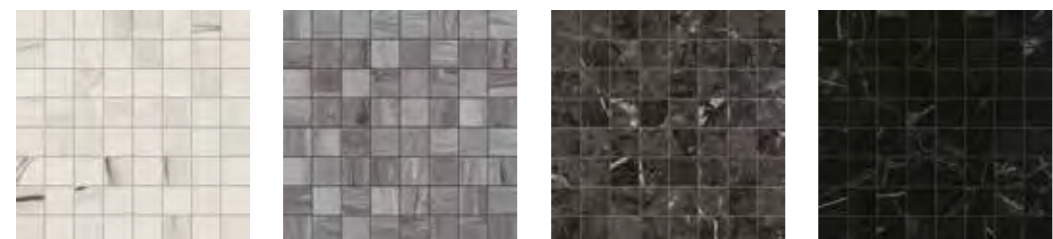

AOVF Marvel Bianco Fantastico Mosaico Matt 30x30 - 11³/₄"x11³/₄"
AOVG Marvel Morning Sky Mosaico Matt 30x30 - 11³/₄"x11³/₄"
AOVD Marvel Grigio Intenso Mosaico Matt 30x30 - 11³/₄"x11³/₄"
AOVI Marvel Black Atlantis Mosaico Matt 30x30 - 11³/₄"x11³/₄"



AOJV Marvel Bianco Fantastico Basket Weave Matt 30,5x30,5 - 12"x12"
AOVL Marvel Morning Sky Basket Weave Matt 30,5x30,5 - 12"x12"
AOVK Marvel Grigio Intenso Basket Weave Matt 30,5x30,5 - 12"x12"

Bianco Fantastico + Black Atlantis | Morning Sky + Black Atlantis | Grigio Intenso + Black Atlantis

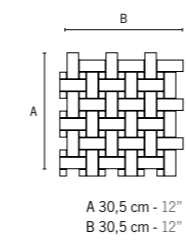

AOVQ Marvel Bianco Fantastico Liberty Lappato 31,8x26,1 - 12⁵/₈"x10³/₄"
AOVR Marvel Morning Sky Liberty Lappato 31,8x26,1 - 12⁵/₈"x10³/₄"
AOVT Marvel Grigio Intenso Liberty Lappato 31,8x26,1 - 12⁵/₈"x10³/₄"
AOVX Marvel Brazil Green Liberty Lappato 31,8x26,1 - 12⁵/₈"x10³/₄"
AOVV Marvel Crystal Beauty Liberty Lappato 31,8x26,1 - 12⁵/₈"x10³/₄"
AOVW Marvel Ultramarine Liberty Lappato 31,8x26,1 - 12⁵/₈"x10³/₄"



AOVO Marvel Brazil Green Leaf Lapp 42,3x27,2 - 16¹/₂"x10⁵/₈"
AOVM Marvel Crystal Beauty Leaf Lapp 42,3x27,2 - 16¹/₂"x10⁵/₈"
AOVN Marvel Ultramarine Leaf Lapp 42,3x27,2 - 16¹/₂"x10⁵/₈"

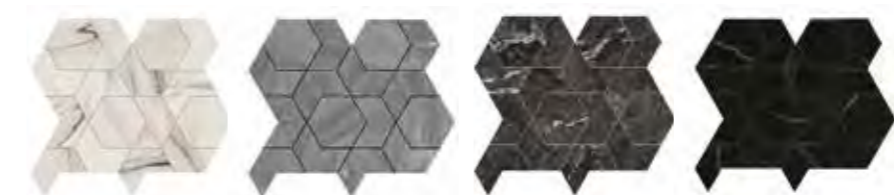
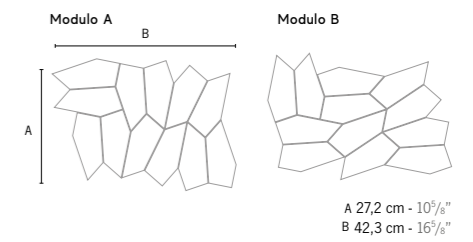
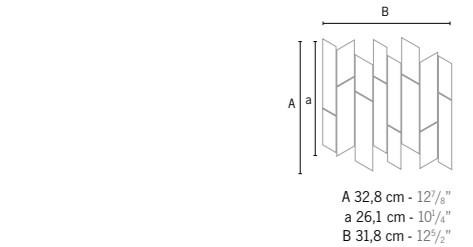

AOVS Marvel Bianco Fantastico Hex 25,4x29,6 - 10"x11⁵/₈"
AOVS Marvel Morning Sky Hex 25,4x29,6 - 10"x11⁵/₈"
AOVS Grigio Intenso Sky Hex 25,4x29,6 - 10"x11⁵/₈"
AOVS Black Atlantis Sky Hex 25,4x29,6 - 10"x11⁵/₈"

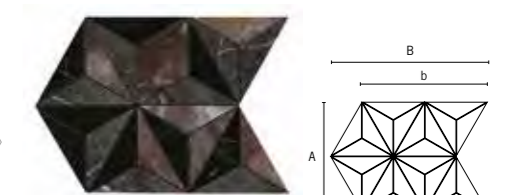
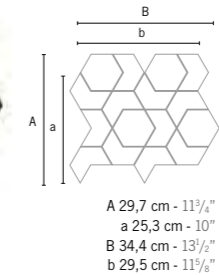

AOVS Marvel Star Lapp 26,7x30,9 - 10¹/₂"x12¹/₈"
 Grigio Intenso + Crystal Beauty + Black Atlantis

TRIM TILES / PEZZI SPECIALI

p. 424

	Battiscopa		Battiscopa		Gradino		Scalino		Scalino		Scalino Angolare				Scalino Angolare				Battiscopa Sag. Scala					
	Lapp.	Matt.	Lapp.	Matt.	Lapp.	Matt.	Lapp.	Matt.	Lapp.	Matt.	Lapp.	Matt.	SX	DX	SX	DX	Lapp.	Matt.	SX	DX				
Bianco F.	AOWE	AOWA	AOV2	AOV6	AO61	AO65	AO7L	AO7H	AO7D	AO69	-	-	APAG	APAF	AO95	AO94	-	-	AO9Z	AO9Y	AO9T	AO9S	AOWL	AOWP
Morning Sky	AOWF	AOWB	AOV3	AOV7	AO62	AO66	AO7M	AO7I	AO7E	AO7A	-	-	APAI	APAH	AO97	AO96	-	-	AO91	AO90	AO9V	AO9U	AOWM	AOWQ
Grigio Intenso	AOWG	AOWC	AOV4	AOV8	AO63	AO67	AO7N	AO7J	AO7F	AO7B	AO98	AO92	-	-	-	-	AO9W	AO9Q	-	-	-	-	AOWN	AOWR
Black Atlantis	AOWH	AOWD	AOV5	AOV9	AO64	AO68	AO7O	AO7K	AO7G	AO7C	AO99	AO93	-	-	-	-	AO9X	AO9R	-	-	-	-	AOWO	AOWS
Crystal Beauty	AOWI	-	-	-	-	-	AO7P	-	-	-	-	-	APAK	APAJ	-	-	-	-	-	-	-	-	-	-
Ultramarine	AOWJ	-	-	-	-	-	AO7Q	-	-	-	APAD	-	-	-	-	-	-	-	-	-	-	-	-	-
Brazil Green	AOWK	-	-	-	-	-	AO7R	-	-	-	APAE	-	-	-	-	-	-	-	-	-	-	-	-	-

* THESE PARTS ARE SUPPLIED TO ORDER | I PEZZI SONO DISPONIBILI SU ORDINAZIONE | Les pièces sont disponibles sur commande | Die Teile sind auf Bestellung lieferbar | Las piezas se hacen por encargo | Изготавливаются на заказ

IBUPEC p. 571



Marvel Dream Wall Tiles / Rivestimento

SHINY SURFACE / SUPERFICIE LUCIDA

WALL TILES p. 502

± 8,5 mm

50x110 cm 19⁵/₈"x43¹/₄"

- 4MDB Marvel Bianco Fantastico 50x110
- 4MDS Marvel Morning Sky 50x110
- 4MDI Marvel Grigio Intenso 50x110
- 4MDN Marvel Black Atlantis 50x110
- 4MDM Marvel Ultramarine 50x110
- 4DMG Marvel Brazil Green 50x110
- 4MDT Marvel Crystal Beauty 50x110

TRIM TILES / PEZZI SPECIALI

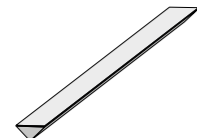

1,4x50 cm - ⁵/₈"x19⁵/₈"

- LD5B Marvel Bianco Fantastico Corner 50 *
- LD5S Marvel Morning Sky Corner 50 *
- LD5G Marvel Grigio Intenso Corner 50 *
- LD5N Marvel Black Atlantis Corner 50 *
- LD5M Marvel Ultramarine Corner 50 *
- LD5E Marvel Brazil Green Corner 50 *
- LD5C Marvel Crystal Beauty Corner 50 *



1,4x1,4 cm - ⁵/₈"x⁵/₈"

- MD1B Marvel Bianco Fantastico Corner A.E. 1,4 *
- MD1S Marvel Morning Sky Corner A.E. 1,4 *
- MD1G Marvel Grigio Intenso Corner A.E. 1,4 *
- MD1N Marvel Black Atlantis Corner A.E. 1,4 *
- MD1M Marvel Ultramarine Corner A.E. 1,4 *
- MD1E Marvel Brazil Green Corner A.E. 1,4 *
- MD1C Marvel Crystal Beauty Corner A.E. 1,4 *

DECORATIVE RANGE / GAMMA DECORATIVA



MOSAICO Q

MOSAICO DIAMONDS

MOSAICO FAN

MOSAICO CHEVRON

* THESE PARTS ARE SUPPLIED TO ORDER. I PEZZI SONO DISPONIBILI SU ORDINAZIONE
Les pièces sont disponibles sur commande | Die Teile sind auf Bestellung lieferbar | Las piezas se hacen por encargo | Изготавливаются на заказ



atlasconcorde

SHINY SURFACE | SUPERFICIE LUCIDA | Surface brillante | Glänzende oberfläche | Superficie brillante | Глянцевая поверхность

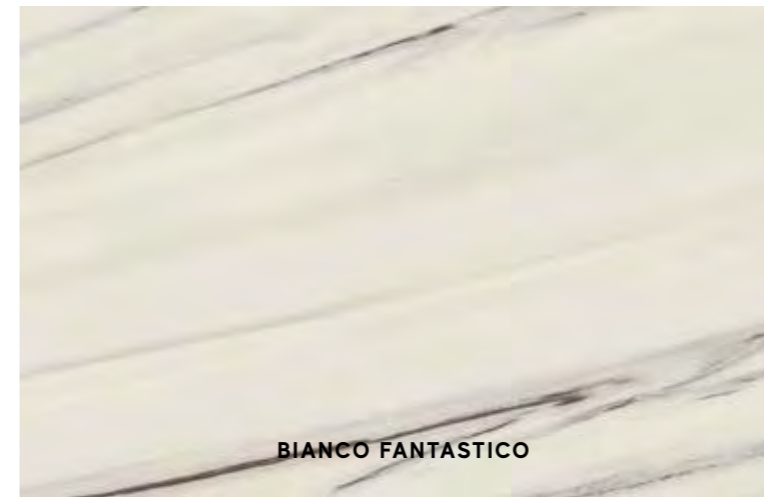

BIANCO FANTASTICO



MORNING SKY



GRIGIO INTENSO



BLACK ATLANTIS

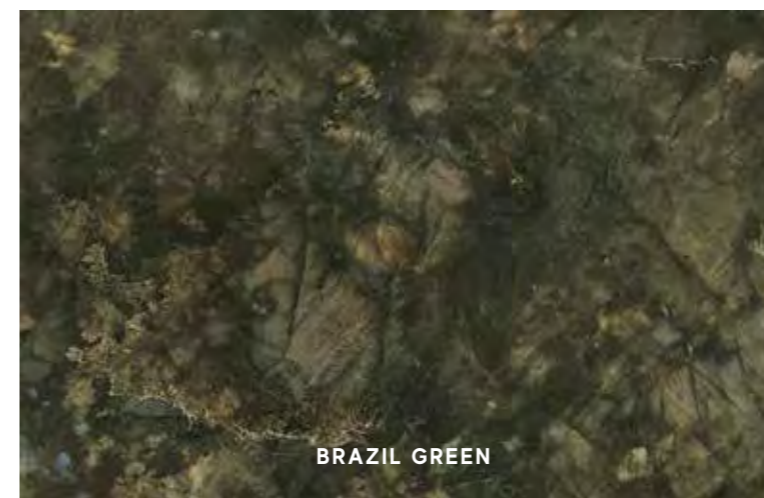

BRAZIL GREEN

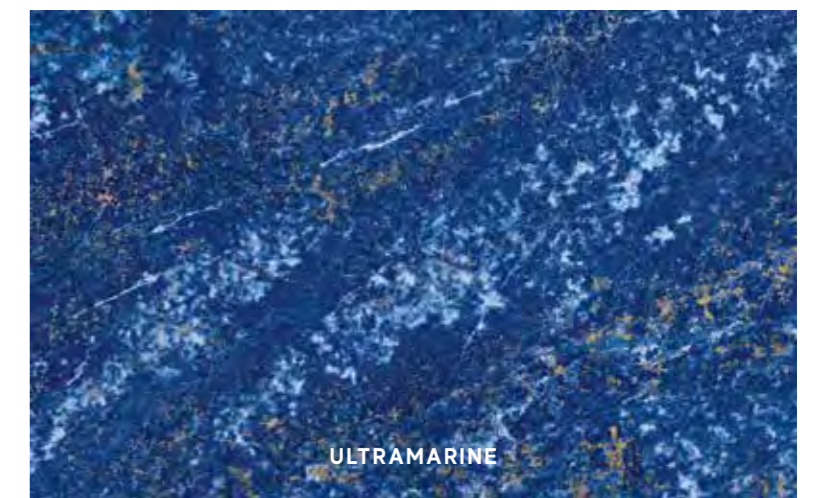

ULTRAMARINE



CRYSTAL BEAUTY



V3 MODERATE VARIATION
Brazil Green,
Morning Sky,
Ultramarine



V2 SLIGHT VARIATION
Bianco Fantastico,
Grigio Intenso,
Crystal Beauty,
Black Atlantis

MARBLE LOOK

195



MARVEL

EDGE

PORCELAIN&WALL TILES

Porcelain Tiles / Gres Porcellanato

COLOURED BODY PORCELAIN TILES - RECTIFIED MONOCALIBER
GRES PORCELLANATO COLORATO IN MASSA - RETTIFICATO MONOCALIBRO

LARGE SIZES p. 366

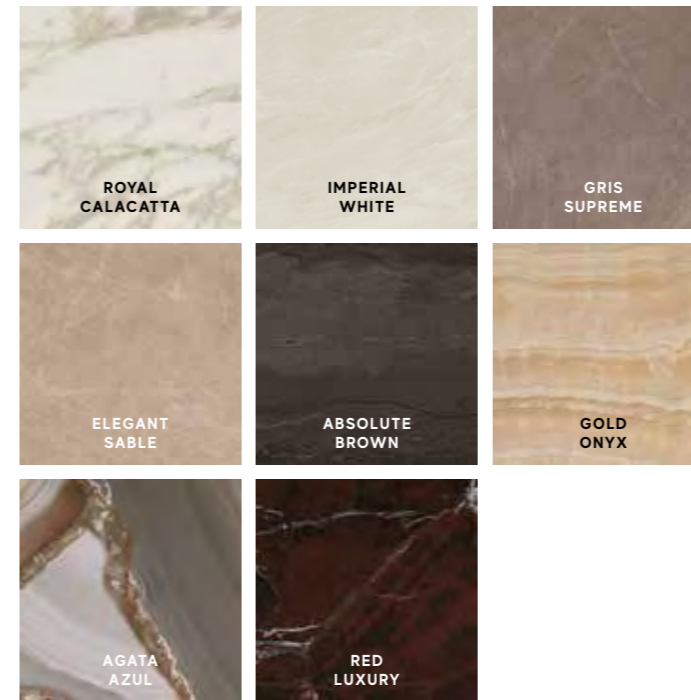

Sizes	Thickness	Surface finish
162x324 cm - 63 ³ / ₄ "x127 ¹ / ₂ " * NON RECTIFIED - NON RETTIFICATO	± 12 mm	Lappato Lux I Silk
120x278 cm - 47 ¹ / ₄ "x109 ¹ / ₂ "	± 6 mm	Polished
120x240 cm - 47 ¹ / ₄ "x94 ¹ / ₂ "	± 9 mm	Polished
120x120 cm - 47 ¹ / ₄ "x47 ¹ / ₄ "	± 9 mm	Polished
75x150 cm - 29 ¹ / ₂ "x59"	± 9 mm	Polished
75x75 cm - 29 ¹ / ₂ "x29 ¹ / ₂ "	± 9 mm	Polished
45x90 cm - 17 ³ / ₄ "x35 ³ / ₈ "	± 9 mm	Polished
60x60 cm - 23 ⁵ / ₈ "x23 ⁵ / ₈ "	± 9 mm	Polished I Matte R9 A
30x60 cm - 11 ³ / ₄ "x23 ⁵ / ₈ "	± 9 mm	Polished I Matte R9 A

Wall Tiles / Rivestimento p. 508

WHITEBODY WALL TILES - RECTIFIED MONOCALIBER
RIVESTIMENTI IN PASTA BIANCA - RETTIFICATO MONOCALIBRO

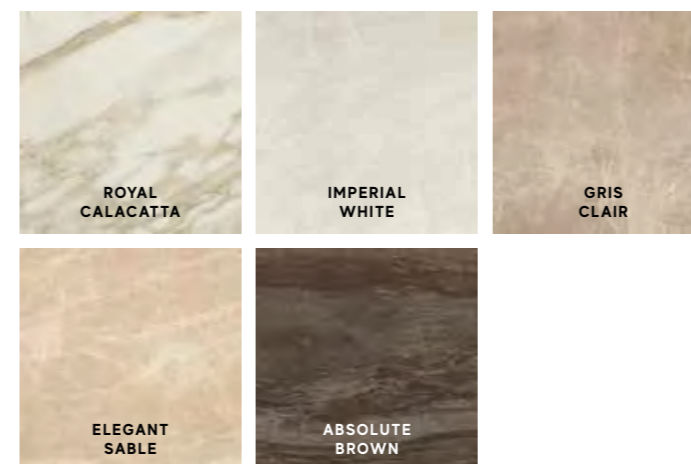

Sizes	Thickness	Surface finish
50x110 cm - 19 ⁵ / ₈ "x43 ¹ / ₄ "	± 8,5 mm	Shiny
40x80 cm - 15 ³ / ₄ "x31 ¹ / ₂ "	± 8,5 mm	Shiny



Marvel Edge Porcelain Tiles / Gres Porcellanato

POLISHED SURFACE / SUPERFICIE LAPPATA

MARBLE LOOK



120x278 cm 47 1/4" x 109 1/2"

A0BH Marvel Royal Calacatta Lappato
A0BI Marvel Royal Calacatta Bookmatch A Lappato
A0BJ Marvel Royal Calacatta Bookmatch B Lappato
A0BK Marvel Imperial White Lappato
A0BL Marvel Elegant Sable Lappato
A0QC Marvel Absolute Brown Lappato

atlasPLAN p. 366



LAPPATO LUX
162x324 cm 63 3/4" x 127 1/2"
> **NON RECTIFIED / NON RETTIFICATO**
AAI6 Calacatta Royal Lap Lux ± 12 mm
AAI7 Calacatta Royal Lap Lux ± 12 mm ST *
ABFB Calacatta Royal Bookmatch Lap Lux ± 12 mm
AA9M Calacatta Royal Bookmatch Lap Lux ± 12 mm ST *



120x240 cm 47 1/4" x 94 1/2"

AENU Marvel Royal Calacatta 120x240 Lappato
AENV Marvel Imperial White 120x240 Lappato
AENR Marvel Elegant Sable 120x240 Lappato
AENS Marvel Gris Supreme 120x240 Lappato
AENT Marvel Absolute Brown 120x240 Lappato

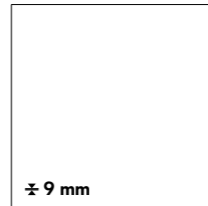

120x120 cm 47 1/4" x 47 1/4"

AENP Marvel Royal Calacatta 120x120 Lappato
AENQ Marvel Imperial White 120x120 Lappato
AENK Marvel Elegant Sable 120x120 Lappato
AENN Marvel Gris Supreme 120x120 Lappato
AENO Marvel Absolute Brown 120x120 Lappato

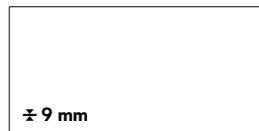

75x150 cm 29 1/2" x 59"

AAIM Marvel Royal Calacatta 75x150 Lappato
AAIN Marvel Imperial White 75x150 Lappato
AAIJ Marvel Elegant Sable 75x150 Lappato
AAIK Marvel Gris Supreme 75x150 Lappato
AAIL Marvel Absolute Brown 75x150 Lappato

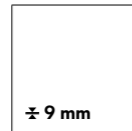

75x75 cm 29 1/2" x 29 1/2"

AAIW Marvel Royal Calacatta 75x75 Lappato
AAIX Marvel Imperial White 75x75 Lappato
AAIS Marvel Elegant Sable 75x75 Lappato
AAIT Marvel Gris Supreme 75x75 Lappato
AAIU Marvel Absolute Brown 75x75 Lappato

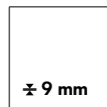

60x60 cm 23 5/8" x 23 5/8"

AEN4 Marvel Royal Calacatta 60x60 Lappato
AEN5 Marvel Imperial White 60x60 Lappato
AEN1 Marvel Elegant Sable 60x60 Lappato
AEN2 Marvel Gris Supreme 60x60 Lappato
AEN3 Marvel Absolute Brown 60x60 Lappato

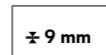

30x60 cm 11 3/4" x 23 5/8"

AEN9 Marvel Royal Calacatta 30x60 Lappato
AEOA Marvel Imperial White 30x60 Lappato
AEN6 Marvel Elegant Sable 30x60 Lappato
AEN7 Marvel Gris Supreme 30x60 Lappato
AEN8 Marvel Absolute Brown 30x60 Lappato



45x90 cm 17 3/4" x 35 5/8"

AENZ Marvel Royal Calacatta 45x90 Lappato
AEN0 Marvel Imperial White 45x90 Lappato
AENW Marvel Elegant Sable 45x90 Lappato
AENX Marvel Gris Supreme 45x90 Lappato
AENY Marvel Absolute Brown 45x90 Lappato

The glossy polished finish is suitable for residential or low-traffic commercial floors, where no anti-slip performance is required, and for walls. The polished glossy surface finish, surprisingly brilliant and bright, features slight irregularities typical of natural marble. The extraordinary brilliance and the easy cleaning of the surface are the result of in-depth research aimed at guaranteeing its durability over time. If the product is in direct contact with the outdoors, provide devices for absorbing moisture and dirt to prevent scratches. / La finitura lappata lucida è indicata per pavimenti residenziali o commerciali poco sollecitati, laddove non siano richieste prestazioni antiscivolo, e per rivestimenti. La finitura lappata lucida offre una superficie sorprendentemente brillante e specchiante, con lievi irregolarità tipiche dei marmi naturali. La straordinaria lucentezza e l'elevata pulibilità della superficie sono frutto di studi approfonditi e accurate ricerche tecniche volte a garantirne la persistenza nel tempo. Se il prodotto è a diretto contatto con l'esterno, prevedere dei dispositivi di assorbimento dell'umidità e della sporcizia per prevenire la formazione di graffi.

POLISHED SURFACE | SUPERFICIE LAPPATA | Surface adouci | Geläppt oberfläche | Superficie bruñido | Полуполированный поверхность

* WITH FIBERGLASS MESH | VERSIONE STUOIATA | Version à nattes | Ausführung mit Glasfasermatte | Versión con malla | С упрочнением из стекловолокна
NON RECTIFIED | NON RETTIFICATO | Non rectifié | Nicht rektifiziert | No rectificada | Неретицированные



ROYAL CALACATTA

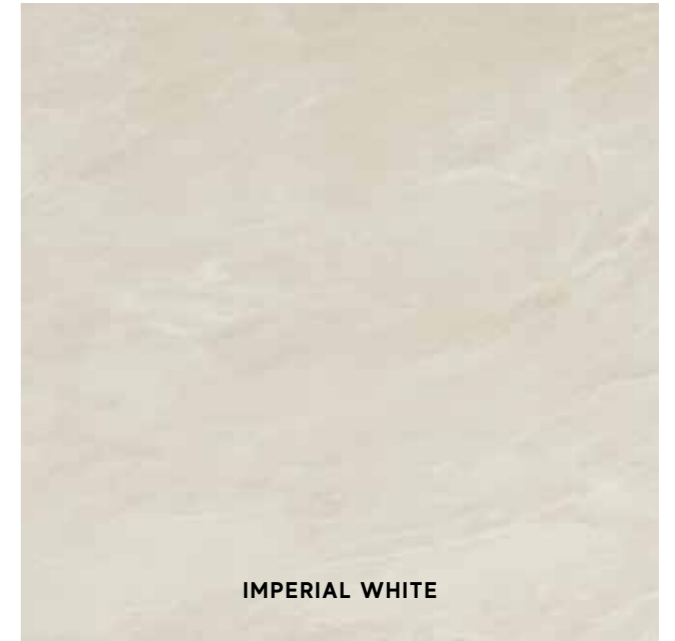

IMPERIAL WHITE



GRIS SUPREME

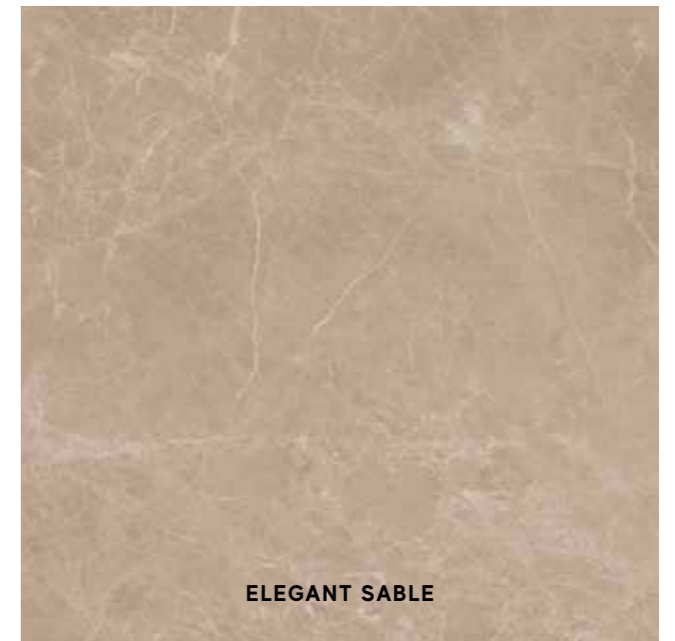

ELEGANT SABLE

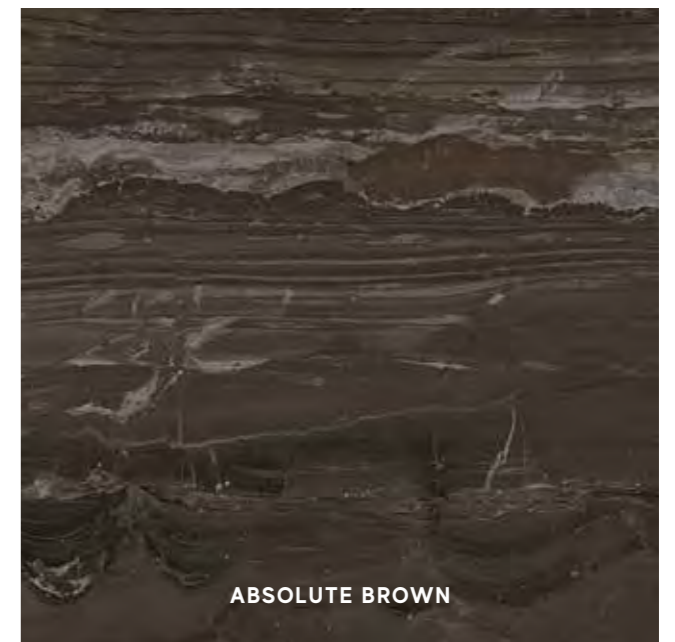

ABSOLUTE BROWN



V3
MODERATE
VARIATION

Royal Calacatta,
Absolute Brown



V2
SLIGHT
VARIATION

Imperial White,
Elegant Sable,
Gris Supreme

MARBLE LOOK



Marvel Edge Porcelain Tiles / Gres Porcellanato

POLISHED SURFACE / SUPERFICIE LAPPATA *



75x150 cm 29 1/2" x 59"
AAIO Marvel Gold Onyx 75x150 Lappato
AAIP Marvel Agata Azul 75x150 Lappato
AAIQ Marvel Red Luxury 75x150 Lappato

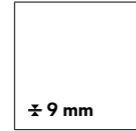

75x75 cm 29 1/2" x 29 1/2"
AAIY Marvel Gold Onyx 75x75 Lappato
AAIØ Marvel Agata Azul 75x75 Lappato
AAI5 Marvel Red Luxury 75x75 Lappato



GOLD ONYX

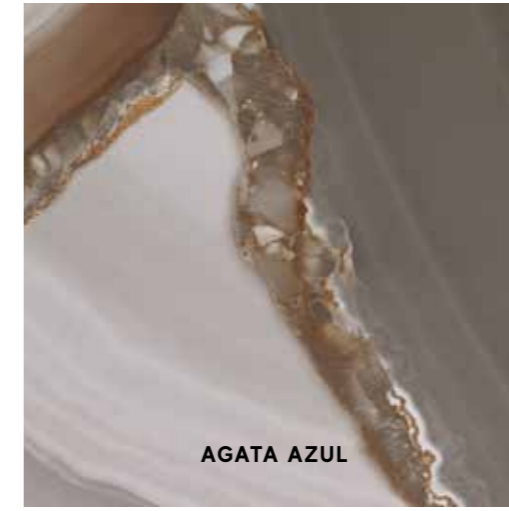

AGATA AZUL



RED LUXURY



MATTE SURFACE / SUPERFICIE MATT

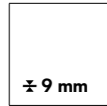

60x60 cm 23 5/8" x 23 5/8"
AE0E Marvel Royal Calacatta 60x60 Matt
AE0F Marvel Imperial White 60x60 Matt
AE0B Marvel Elegant Sable 60x60 Matt
AE0C Marvel Gris Supreme 60x60 Matt
AE0D Marvel Absolute Brown 60x60 Matt

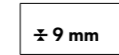

30x60 cm 11 3/4" x 23 5/8"
AE0J Marvel Royal Calacatta 30x60 Matt
AE0K Marvel Imperial White 30x60 Matt
AE0G Marvel Elegant Sable 30x60 Matt
AE0H Marvel Gris Supreme 30x60 Matt
AE0I Marvel Absolute Brown 30x60 Matt



ROYAL CALACATTA



IMPERIAL WHITE



ELEGANT SABLE



GRIS SUPREME

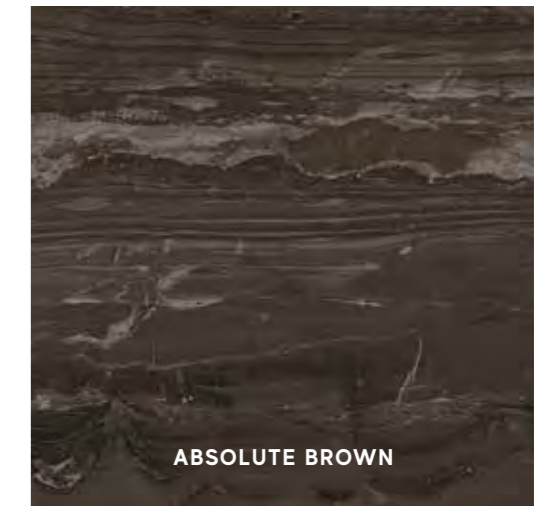

ABSOLUTE BROWN



V3 MODERATE VARIATION

Royal Calacatta, Absolute Brown, Gold Onyx, Agata Azul, Red Luxury



V2 SLIGHT VARIATION

Imperial White, Elegant Sable, Gris Supreme

* The glossy polished finish is suitable for residential or low-traffic commercial floors, where no anti-slip performance is required, and for walls. The polished glossy surface finish, surprisingly brilliant and bright, features slight irregularities typical of natural marble. The extraordinary brilliance and the easy cleaning of the surface are the result of in-depth research aimed at guaranteeing its durability over time. - If the product is in direct contact with the outdoors, provide devices for absorbing moisture and dirt to prevent scratches. / La finitura lappata lucida è indicata per pavimenti residenziali o commerciali poco sollecitati, laddove non siano richieste prestazioni antiscivolo, e per rivestimenti. La finitura lappata lucida offre una superficie sorprendentemente brillante e specchiante, con lievi irregolarità tipiche dei marmi naturali. La straordinaria lucentezza e l'elevata pulibilità della superficie sono frutto di studi approfonditi e accurate ricerche tecniche volte a garantirne la persistenza nel tempo. - Se il prodotto è a diretto contatto con l'esterno, prevedere dei dispositivi di assorbimento dell'umidità e della sporcizia per prevenire la formazione di graffi.

POLISHED SURFACE | SUPERFICIE LAPPATA | Surface adouci | Geläppte Oberfläche | Superficie brufido | Полуполированный поверхность
MATTE SURFACE | SUPERFICIE MATT | Surface Mat | Matt oberfläche | Superficie Mate | Матовая поверхность

* **WITH FIBERGLASS MESH** | VERSIONE STUOIATA | Version à nattes | Ausführung mit Glasfasermatte | Versión con malla | С упрочнением из стекловолокон
NON RECTIFIED | NON RETTIFICATO | Non rectifié | Nicht rektifiziert | No rectificada | Неретифицированные

Marvel Edge Porcelain Tiles / Gres Porcellanato

DECOR RANGE / GAMMA DECORI

MARBLE LOOK

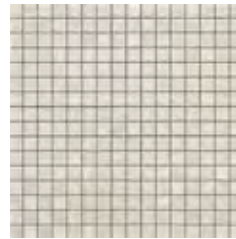

AEOZ Marvel Imperial White Mosaico Lappato
30x30 - 11³/₄"x11³/₄"

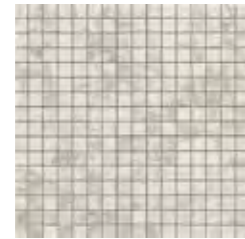

AEOY Marvel Royal Calacatta Mosaico Lappato
30x30 - 11³/₄"x11³/₄"

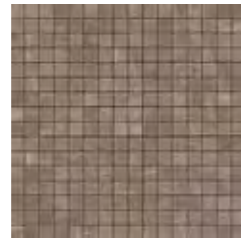

AEOV Marvel Gris Supreme Mosaico Lappato
30x30 - 11³/₄"x11³/₄"

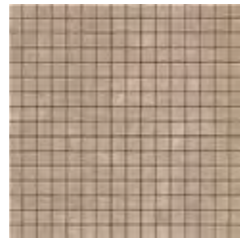

AEOX Marvel Absolute Brown Mosaico Lappato
30x30 - 11³/₄"x11³/₄"

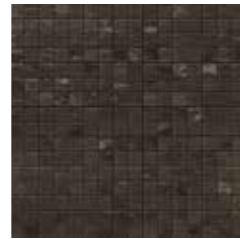

AEOY Marvel Royal Calacatta Mosaico Lappato
30x30 - 11³/₄"x11³/₄"

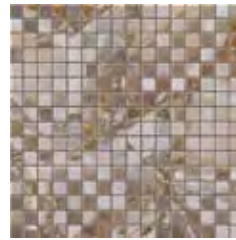

AEO1 Marvel Agata Azul Mosaico Lappato
30x30 - 11³/₄"x11³/₄"



AEO0 Marvel Gold Onyx Mosaico Lappato
30x30 - 11³/₄"x11³/₄"

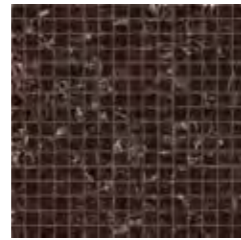

AEO2 Marvel Red Luxury Mosaico Lappato
30x30 - 11³/₄"x11³/₄"



AEOU Marvel Imperial White Mosaico Matt
30x30 - 11³/₄"x11³/₄"



AEO7 Marvel Royal Calacatta Mosaico Matt
30x30 - 11³/₄"x11³/₄"

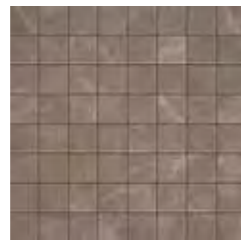

AEO8 Marvel Gris Supreme Mosaico Matt
30x30 - 11³/₄"x11³/₄"



AEO9 Marvel Elegant Sable Mosaico Matt
30x30 - 11³/₄"x11³/₄"

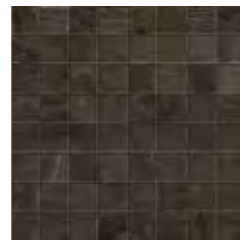

AEO5 Marvel Absolute Brown Mosaico Matt
30x30 - 11³/₄"x11³/₄"



AEP7 Marvel Imperial White Mosaico Twill Lappato
30x31 - 11³/₄"x12¹/₄"



AEPS Marvel Royal Calacatta Mosaico Twill Lappato
30x31 - 11³/₄"x12¹/₄"



AEPQ Marvel Gris Supreme Mosaico Twill Lappato
30x31 - 11³/₄"x12¹/₄"



AEP0 Marvel Elegant Sable Mosaico Twill Lappato
30x31 - 11³/₄"x12¹/₄"



AEP8 Marvel Absolute Brown Mosaico Twill Lappato
30x31 - 11³/₄"x12¹/₄"

Imperial White + Gris Supreme

Royal Calacatta + Gris Supreme

Gris Supreme + Royal Calacatta

Elegant Sable + Absolute Brown

Absolute Brown + Elegant Sable

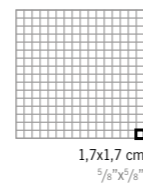

1,7x1,7 cm
3/8"x3/8"
3,5x3,5 cm
1 1/8"x1 1/8"

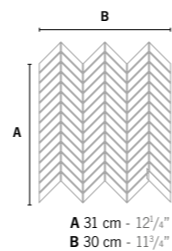

A 31 cm - 12 1/4"
B 30 cm - 11 3/4"



AEPN Marvel Imperial White Mosaico Esagono Lappato
30x35 - 11³/₄"x13³/₄"



AEPM Marvel Royal Calacatta Mosaico Esagono Lappato
30x35 - 11³/₄"x13³/₄"



AEPK Marvel Gris Supreme Mosaico Esagono Lappato
30x35 - 11³/₄"x13³/₄"



AEPJ Marvel Elegant Sable Mosaico Esagono Lappato
30x35 - 11³/₄"x13³/₄"



AEPL Marvel Absolute Brown Mosaico Esagono Lappato
30x35 - 11³/₄"x13³/₄"



AEP1 Marvel Imperial White Mosaico 3D
30,5x26,4 - 12"x10³/₈"



AEPH Marvel Royal Calacatta Mosaico 3D
30,5x26,4 - 12"x10³/₈"



AEPF Marvel Gris Supreme Mosaico 3D
30,5x26,4 - 12"x10³/₈"



AEP2 Marvel Elegant Sable Mosaico 3D
30,5x26,4 - 12"x10³/₈"



AEPG Marvel Absolute Brown Mosaico 3D
30,5x26,4 - 12"x10³/₈"

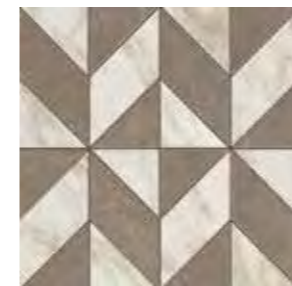

AEP4 Marvel Gris-Calacatta Mosaico Cubes Lappato
36,5x36,5 - 14³/₈"x14³/₈"

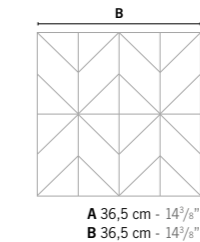

A 36,5 cm - 14³/₈"
B 36,5 cm - 14³/₈"

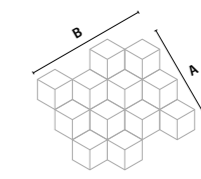

A 26,4 cm - 10³/₈"
B 30,5 cm - 12"

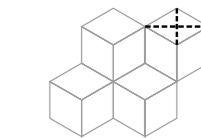

10x17 cm
3 1/8"x6 1/4"

TRIM TILES / PEZZI SPECIALI

p. 424

UPEC p. 571

		Battiscopa 7,2x60 - 2 7/8"x23 5/8"		Battiscopa Digitale 4,6x60 - 1 3/4"x23 5/8"		Gradino * 30x60 11 3/4"x23 5/8"	Scalino Lappato * 33x150 13"x59"	Scalino Lappato * 33x90 13"x35 5/8"	Scalino * 33x60 - 13"x23 5/8"		Scalino Ang. 33x33 - 13"x13"				Battiscopa Matt Sag. Scala 7,2x30 - 2 7/8"x11 3/4"			
		Lappato		Matt					Lappato		Matt		DX * SX *		DX * SX *		DX *	SX *
		Lappato	Matt	Lappato	Matt				Lappato	Matt	DX *	SX *	DX *	SX *				
	Elegant Sable	AFA9	AFA4	AFB0	AFBH	AFB4	AFCO	AFCJ	AFCE	AFB9	AFC2	AFCW	AFBT	AFBZ				
	Gris Supreme	AFBA	AFA5	AFBP	AFBJ	AFB5	AFCP	AFCK	AFCF	AFCA	AFC3	AFCX	AFBV	AFBØ				
	Absolute Brown	AFBC	AFA6	AFBQ	AFBK	AFB6	AFCQ	AFCL	AFCG	AFCB	AFC6	AFC7	AFCØ	AFC1	AFBW	AFB1		
	Royal Calacatta	AFBD	AFA7	AFBR	AFBM	AFB7	AFCR	AFCM	AFCH	AFCC	AFC4	AFCY	AFBX	AFB2				
	Imperial White	AFBF	AFA8	AFBS	AFBN	AFB8	AFCS	AFCN	AFCI	AFCD	AFC5	AFCZ	AFBY	AFB3				
	Gold Onyx	-	-	-	-	-	AFCT	-	-	-	-	-	-	-				
	Agata Azul	-	-	-	-	-	AFCU	-	-	-	-	-	-	-				
	Red Luxury	-	-	-	-	-	AFCV	-	-	-	-	-	-	-				

* THESE PARTS ARE SUPPLIED TO ORDER | I PEZZI SONO DISPONIBILI SU ORDINAZIONE | Les pièces sont disponibles sur commande | Die Teile sind auf Bestellung lieferbar | Las piezas se hacen por encargo | Изготавливаются на заказ

THE DECORATION CAN ONLY BE LAID ON THE WALL | IL DECORO SI PUÒ POSARE SOLO A RIVESTIMENTO
Décor uniquement mural | Das Dekor kann nur an der Wand verlegt werden | La decoración se puede colocar únicamente en paredes | Декор может быть уложен только на стену.



Marvel Edge Wall Tiles / Rivestimento

WALL TILES p. 508

SHINY SURFACE / SUPERFICIE LUCIDA



± 8,5 mm

50x110 cm 19^{5/8}"x43^{1/4}"
4MER Marvel Royal Calacatta 50x110
4MEW Marvel Imperial White 50x110
4MES Marvel Elegant Sable 50x110



± 8,5 mm

40x80 cm 15^{3/4}"x31^{1/2}"
9MER Marvel Royal Calacatta 40x80
9MEW Marvel Imperial White 40x80
9MES Marvel Elegant Sable 40x80
9EMG Marvel Gris Clair 40x80
9MEB Marvel Absolute Brown 40x80

TRIM TILES / PEZZI SPECIALI



1,4x50 cm - 5/8"x19^{5/8}"
LM5C Marvel Royal Calacatta Corner 50 •
LM5W Marvel Imperial White Corner 50 •
LM5S Marvel Elegant Sable Corner 50 •

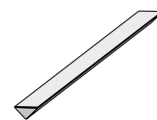

1,4x40 cm - 5/8"x15^{3/4}"
LM4C Marvel Royal Calacatta Corner 40 •
LM4W Marvel Imperial White Corner 40 •
LM4S Marvel Elegant Sable Corner 40 •
LM4G Marvel Gris Clair Corner 40 •
LM4O Marvel Absolute Brown Corner 40 •



1,4x1,4 cm - 5/8"x5/8"
AMCY Marvel Royal Calacatta Corner A.E. •
AMCX Marvel Imperial White Corner A.E. •
AMCS Marvel Elegant Sable Corner A.E. •
AMCR Marvel Gris Clair Corner A.E. •
AMCO Marvel Absolute Brown Corner A.E. •

DECORATIVE RANGE / GAMMA DECORATIVA

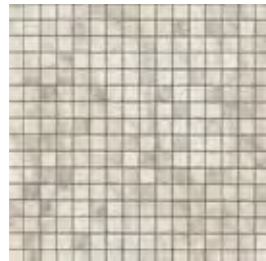

MOSAIC Q



DROP MOSAIC



GOLD HEX



GOLD VEIN

* THESE PARTS ARE SUPPLIED TO ORDER . I PEZZI SONO DISPONIBILI SU ORDINAZIONE
Les pièces sont disponibles sur commande | Die Teile sind auf Bestellung lieferbar | Las piezas se hacen por encargo | Изготавливаются на заказ



SHINY SURFACE | SUPERFICIE LUCIDA | Surface brillante | Glänzende oberfläche | Superficie brillante | Глянцевая поверхность



ROYAL CALACATTA



IMPERIAL WHITE



GRIS CLAIR



ELEGANT SABLE

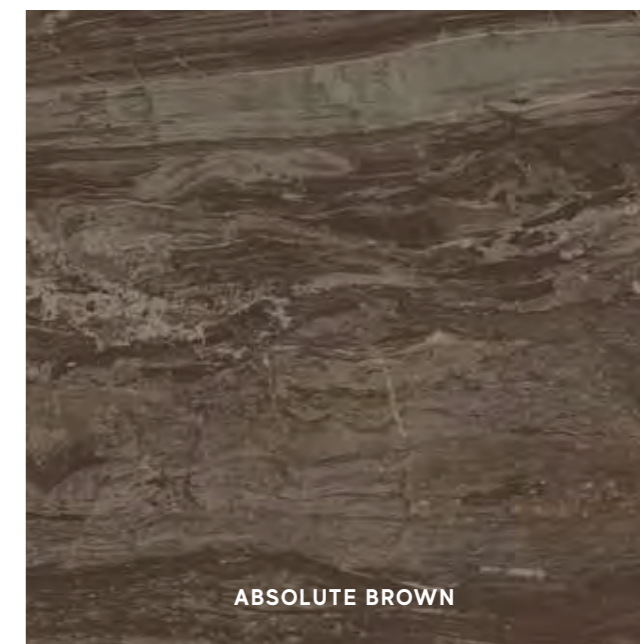

ABSOLUTE BROWN



**V3
MODERATE
VARIATION**

Royal Calacatta,
Absolute Brown



**V2
SLIGHT
VARIATION**

Imperial White,
Elegant Sable,
Gris Clair

MARBLE LOOK

205



MARVEL

GEMS

PORCELAIN TILES

Porcelain Tiles / Gres Porcellanato

COLOURED BODY PORCELAIN TILES - RECTIFIED MONOCALIBER
GRES PORCELLANATO COLORATO IN MASSA - RETTIFICATO MONOCALIBRO

POLISHED SURFACE / SUPERFICIE LAPPATA

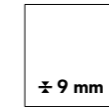
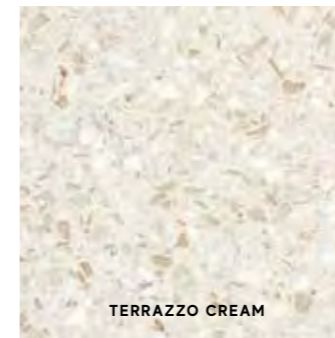

60x60 cm 23⁵/₈"x23⁵/₈"
 AZY6 Marvel Terrazzo White 60x60 Lappato
 AZY7 Marvel Terrazzo Pearl 60x60 Lappato
 AZY8 Marvel Terrazzo Cream 60x60 Lappato
 AZY9 Marvel Terrazzo Grey 60x60 Lappato
 AZZA Marvel Terrazzo Black 60x60 Lappato
 AZZD Marvel Palladiana Carrara 60x60 Lappato

MATTE SURFACE / SUPERFICIE MATT

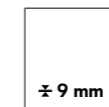

60x60 cm 23⁵/₈"x23⁵/₈"
 ATW3 Marvel Terrazzo White 60x60 Matt
 ATW4 Marvel Terrazzo Pearl 60x60 Matt
 ATW5 Marvel Terrazzo Cream 60x60 Matt
 ATW6 Marvel Terrazzo Grey 60x60 Matt
 ATW7 Marvel Terrazzo Black 60x60 Matt







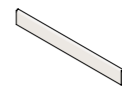
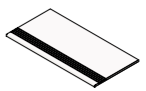
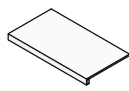
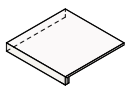
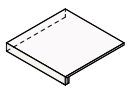

V2 SLIGHT VARIATION
 Terrazzo White,
 Terrazzo Pearl,
 Terrazzo Grey,
 Terrazzo Cream,
 Terrazzo Black,
 Palladiana Carrara

TRIM TILES / PEZZI SPECIALI

p. 424

UPEC p. 571

					
	Battiscopa 7,2x60 - 2 ⁷ / ₈ "x23 ⁵ / ₈ "	Battiscopa Digitale 4,6x60 - 1 ³ / ₄ "x23 ⁵ / ₈ "	Gradino * 30x60 - 11 ³ / ₄ "x23 ⁵ / ₈ "	Scalino * 33x60 - 13"x23 ⁵ / ₈ "	Scalino Angolare * 33x33 - 13"x13"
	Matt	Matt	Matt	Matt	Matt
 Terrazzo White	AT9M	AT9H	AUDB	AT9R	AS8Y
 Terrazzo Pearl	AT9N	AT9I	AUDC	AT9T	AS8Z
 Terrazzo Cream	AT9O	AT9J	AUDD	AT9U	AS8Ø
 Terrazzo Grey	AT9P	AT9K	AUDE	AT9V	AS81
 Terrazzo Black	AT9Q	AT9L	AUDF	AT9W	AS82

The glossy polished finish is suitable for residential or low-traffic commercial floors, where no anti-slip performance is required, and for walls. The polished glossy surface finish, surprisingly brilliant and bright, features slight irregularities typical of natural marble. The extraordinary brilliance and the easy cleaning of the surface are the result of in-depth research aimed at guaranteeing its durability over time. If the product is in direct contact with the outdoors, provide devices for absorbing moisture and dirt to prevent scratches. / La finitura lappata lucida è indicata per pavimenti residenziali o commerciali poco sollecitati, laddove non siano richieste prestazioni antiscivolo, e per rivestimenti. La finitura lappata lucida offre una superficie sorprendentemente brillante e specchiante, con lievi irregolarità tipiche dei marmi naturali. La straordinaria lucentezza e l'elevata pulibilità della superficie sono frutto di studi approfonditi e accurate ricerche tecniche volte a garantirne la persistenza nel tempo. Se il prodotto è a diretto contatto con l'esterno, prevedere dei dispositivi di assorbimento dell'umidità e della sporcizia per prevenire la formazione di graffi.

POLISHED SURFACE | SUPERFICIE LAPPATA | Surface adouci | Geläpft oberfläche | Superficie brulido | Полуполированный поверхность
MATTE SURFACE | SUPERFICIE MATT | Surface Mat | Matt oberfläche | Superficie Mate | Матовая поверхность
COLOURED BODY PORCELAIN TILES | GRES PORCELLANATO COLORATO IN MASSA | Grès cérame coloré dans la masse | Durchgefärbtes Feinsteinzeug | Gres porcelánico coloreado en masa | Керамический гранит окрашенный в массу
RECTIFIED MONOCALIBER | RETTIFICATO MONOCALIBRO | Rectifié mono-calibre | Geschliffen einkalbrig | Rectificado monocalibre | Ретифицированный в одном калибре



atlas concorde

MARVEL
PRO

PORCELAIN&WALL TILES

Porcelain Tiles / Gres Porcellanato

COLOURED BODY PORCELAIN TILES - RECTIFIED MONOCALIBER
GRES PORCELLANATO COLORATO IN MASSA - RETTIFICATO MONOCALIBRO

LARGE SIZES p. 366

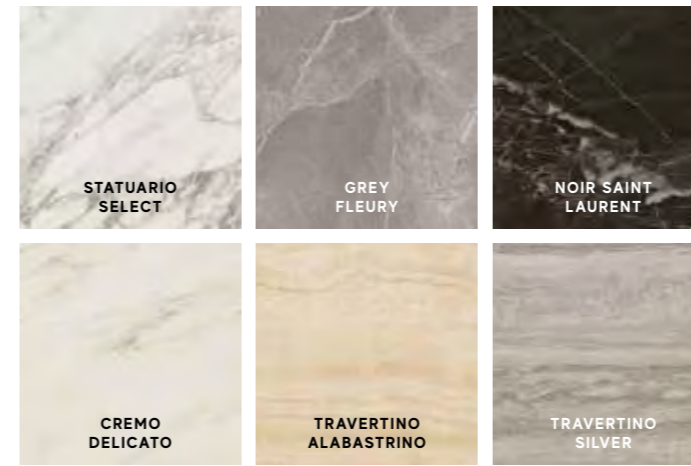

Sizes	Thickness	Surface finish
162x324 cm - 63 ³ / ₄ "x127 ¹ / ₂ " NON RECTIFIED - NON RETTIFICATO	± 12 mm	Lappato Lux I Silk
160x320 cm - 63"x126"	± 6 mm	Polished
160x160 cm - 63"x63"	± 6 mm	Polished
120x278 cm - 47 ¹ / ₄ "x109 ¹ / ₂ "	± 6 mm	Polished I Matte R9 A
120x240 cm - 47 ¹ / ₄ "x94 ¹ / ₂ "	± 9 mm	Polished
120x120 cm - 47 ¹ / ₄ "x47 ¹ / ₄ "	± 9 mm	Polished I Matte R9 A
60x120 cm - 23 ⁵ / ₈ "x47 ¹ / ₄ "	± 9 mm	Polished I Matte R9 A
75x150 cm - 29 ¹ / ₂ "x59"	± 9 mm	Polished
75x75 cm - 29 ¹ / ₂ "x29 ¹ / ₂ "	± 9 mm	Polished
45x90 cm - 17 ³ / ₄ "x35 ³ / ₈ "	± 9 mm	Polished I Matte R9 A
60x60 cm - 23 ⁵ / ₈ "x23 ⁵ / ₈ "	± 9 mm	Polished I Satin I Matte R9 A
30x60 cm - 11 ³ / ₄ "x23 ⁵ / ₈ "	± 9 mm	Polished I Matte R9 A

Outdoor Paving and Wet Areas

OUTDOOR PAVING p. 408

Sizes	Thickness	Surface finish
30x60 cm - 11 ³ / ₄ "x23 ⁵ / ₈ "	± 9 mm	Textured R11 A+B
60x60 cm - 23 ⁵ / ₈ "x23 ⁵ / ₈ "	± 20 mm	Textured R11 A+B+C

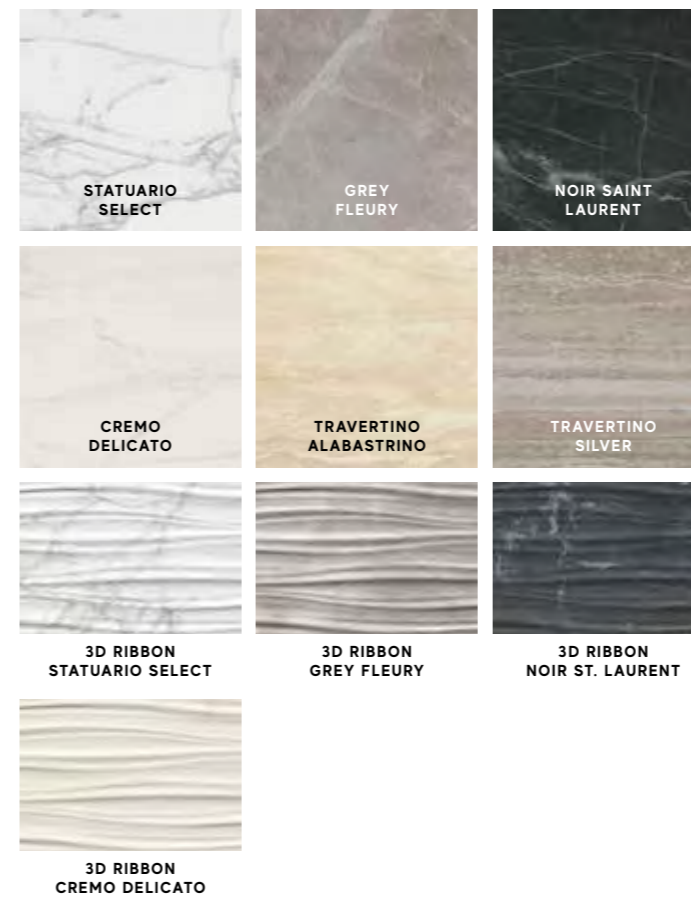

Wall Tiles / Rivestimento p. 516

WHITEBODY WALL TILES - RECTIFIED MONOCALIBER
RIVESTIMENTI IN PASTA BIANCA - RETTIFICATO MONOCALIBRO

Sizes	Thickness	Surface finish
50x110 cm - 19 ⁵ / ₈ "x43 ¹ / ₄ "	± 8,5 mm	Shiny
40x80 cm - 15 ³ / ₄ "x31 ¹ / ₂ "	± 8,5 mm	Shiny
30,5x91,5 cm - 12"x36"	± 8,5 mm	Shiny
8x31,5 cm - 3 ¹ / ₈ "x12 ³ / ₈ "	± 8,5 mm	Shiny

3D Wall Tiles

Sizes	Thickness	Surface finish
40x80 cm - 15 ³ / ₄ "x31 ¹ / ₂ "	± 10 mm	Shiny



Marvel Pro Porcelain Tiles / Gres Porcellanato

POLISHED SURFACE / SUPERFICIE LAPPATA

MARBLE LOOK



160x320 cm 63"x126"

A05V Marvel Statuario Select 160x320RT Lappato
A05W Marvel Crema Delicata 160x320RT Lappato

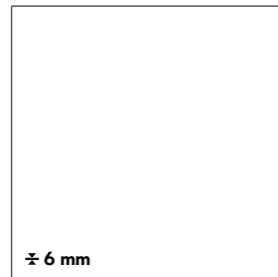

160x160 cm 63"x63"

A052 Marvel Crema Delicata 160x160RT Lappato



LAPPATO LUX
162x324 cm 63³/₄"x127¹/₂"
> **NON RECTIFIED / NON RETTIFICATO**
ANV1 Statuario Select A Lap Lux ± 12 mm
ANV2 Statuario Select A Lap Lux ± 12 mm ST *
ANV3 Statuario Select A Bookmatch Lap Lux ± 12 mm
ANV4 Statuario Select A Bookmatch Lap Lux ± 12 mm ST *



120x278 cm 47¹/₄"x109¹/₂"

A08N Marvel Statuario Select 120x278 Lappato
A08O Marvel Crema Delicata 120x278 Lappato
A2RX Marvel Grey Fleury 120x278 Lappato



120x240 cm 47¹/₄"x94¹/₂"

AY2P Marvel Statuario Select 120x240 Lappato
AY2Q Marvel Crema Delicata 120x240 Lappato

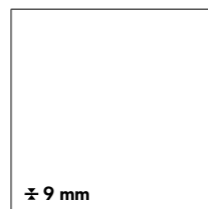

120x120 cm 47¹/₄"x47¹/₄"

AY2T Marvel Statuario Select 120x120 Lappato
AY2U Marvel Crema Delicata 120x120 Lappato
A210 Marvel Grey Fleury 120x120 Lappato

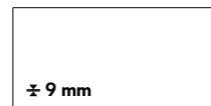

60x120 cm 23³/₈"x47¹/₄"

A21N Marvel Crema Delicata 60x120 Lappato
A21M Marvel Grey Fleury 60x120 Lappato

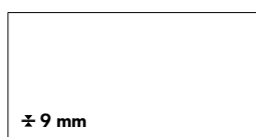

75x150 cm 29¹/₂"x59"

AD43 Marvel Statuario Select 75x150 Lappato
AD45 Marvel Crema Delicata 75x150 Lappato
AD47 Marvel Grey Fleury 75x150 Lappato
AD48 Marvel Noir St. Laurent 75x150 Lappato
AD44 Marvel Travertino Alabastrino 75x150 Lappato
AD46 Marvel Travertino Silver 75x150 Lappato

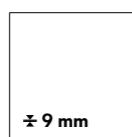

75x75 cm 29¹/₂"x29¹/₂"

AD4U Marvel Statuario Select 75x75 Lappato
AD4W Marvel Crema Delicata 75x75 Lappato
AD4Y Marvel Grey Fleury 75x75 Lappato
AD4Z Marvel Noir St. Laurent 75x75 Lappato
AD4V Marvel Travertino Alabastrino 75x75 Lappato
AD4X Marvel Travertino Silver 75x75 Lappato

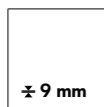

60x60 cm 23⁵/₈"x23⁵/₈"

ADUM Marvel Statuario Select 60x60 Lappato
ADUK Marvel Crema Delicata 60x60 Lappato
ADUO Marvel Grey Fleury 60x60 Lappato
ADUP Marvel Noir St. Laurent 60x60 Lappato
ADUL Marvel Travertino Alabastrino 60x60 Lappato
ADUN Marvel Travertino Silver 60x60 Lappato

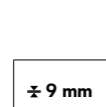

30x60 cm 11³/₄"x23⁵/₈"

D032 Marvel Statuario Select 30x60 Lappato
D030 Marvel Crema Delicata 30x60 Lappato
D034 Marvel Grey Fleury 30x60 Lappato
D035 Marvel Noir St. Laurent 30x60 Lappato
D031 Marvel Travertino Alabastrino 30x60 Lappato
D033 Marvel Travertino Silver 30x60 Lappato

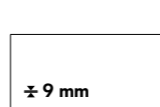

45x90 cm 17³/₄"x35³/₈"

AD49 Marvel Statuario Select 45x90 Lappato
AD5B Marvel Crema Delicata 45x90 Lappato
AD5D Marvel Grey Fleury 45x90 Lappato
AD5E Marvel Noir St. Laurent 45x90 Lappato
AD5A Marvel Travertino Alabastrino 45x90 Lappato
AD5C Marvel Travertino Silver 45x90 Lappato

The glossy polished finish is suitable for residential or low-traffic commercial floors, where no anti-slip performance is required, and for walls. The polished glossy surface finish, surprisingly brilliant and bright, features slight irregularities typical of natural marble. The extraordinary brilliance and the easy cleaning of the surface are the result of in-depth research aimed at guaranteeing its durability over time. - If the product is in direct contact with the outdoors, provide devices for absorbing moisture and dirt to prevent scratches. / La finitura lappata lucida è indicata per pavimenti residenziali o commerciali poco sollecitati, laddove non siano richieste prestazioni antiscivolo, e per rivestimenti. La finitura lappata lucida offre una superficie sorprendentemente brillante e specchiante, con lievi irregolarità tipiche dei marmi naturali. La straordinaria lucentezza e l'elevata pulibilità della superficie sono frutto di studi approfonditi e accurate ricerche tecniche volte a garantirne la persistenza nel tempo. - Se il prodotto è a diretto contatto con l'esterno, prevedere dei dispositivi di assorbimento dell'umidità e della sporcizia per prevenire la formazione di graffi.

POLISHED SURFACE | SUPERFICIE LAPPATA | Surface adouci | Geläppte Oberfläche | Superficie bruñido | Полиполированный поверхность

* WITH FIBERGLASS MESH | VERSIONE STUOIATA | Version à nattes | Ausführung mit Glasfasermatte | Versión con malla | С упрочнением из стекловолоконна
NON RECTIFIED | NON RETTIFICATO | Non rectifié | Nicht rektifiziert | No rectificada | Неретицированные



STATUARIO SELECT



CREMA DELICATO

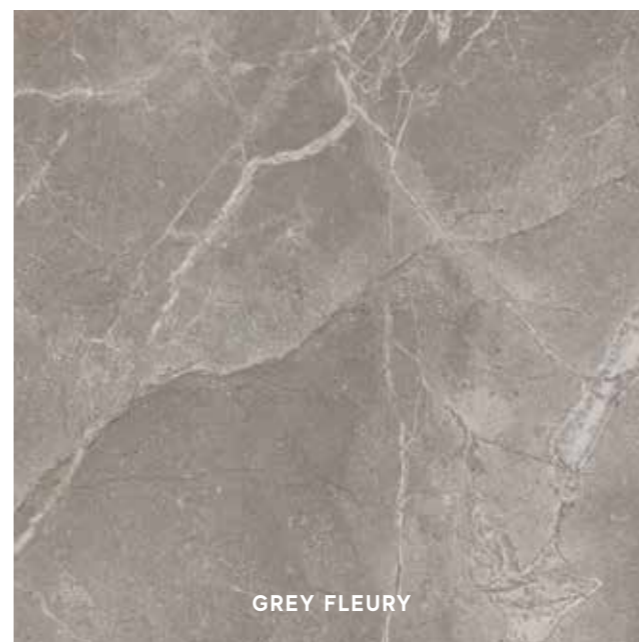

GREY FLEURY

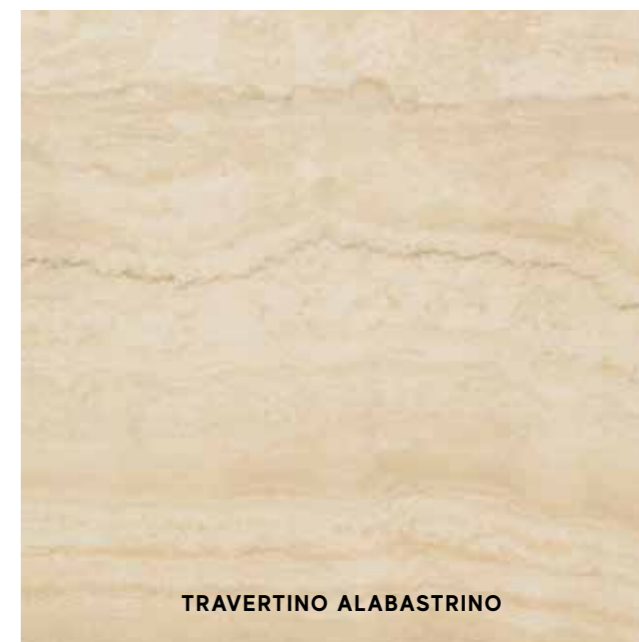

TRAVERTINO ALABASTRINO



NOIR SAINT LAURENT



TRAVERTINO SILVER



V3
MODERATE
VARIATION
Statuario Select,
Grey Fleury



V2
SLIGHT
VARIATION
Crema Delicata,
Travertino Alabastrino,
Travertino Silver,
Noir St. Laurent

MARBLE LOOK



Marvel Pro Porcelain Tiles / Gres Porcellanato

MATTE SURFACE / SUPERFICIE MATT



120x278 cm 47¹/₄"x109¹/₂"
A2RU Marvel Crema Delicato 120x278 Matt
A2RT Marvel Grey Fleury 120x278 Matt

atlasPLAN p. 366



LAPPATO LUX
162x324 cm 63³/₄"x127¹/₂"
> **NON RECTIFIED / NON RETTIFICATO**
AMJ1 Statuario Select A Silk ± 12 mm
AMJ2 Statuario Select A Silk ± 12 mm ST *
AMJ3 Statuario Select A Bookmatch Silk ± 12 mm
AMJ4 Statuario Select A Bookmatch Silk ± 12 mm ST *

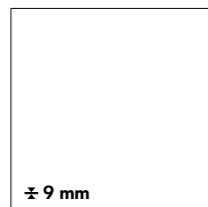

120x120 cm 47¹/₄"x47¹/₄"
A206 Marvel Crema Delicato 120x120 Matt
A205 Marvel Grey Fleury 120x120 Matt

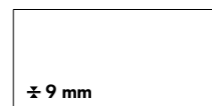

60x120 cm 23³/₈"x47¹/₄"
A21G Marvel Crema Delicato 60x120 Matt
A21F Marvel Grey Fleury 60x120 Matt

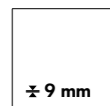

60x60 cm 23³/₈"x23³/₈"
AVGC Marvel Statuario Select 60x60
AVGD Marvel Crema Delicato 60x60
AVGF Marvel Grey Fleury 60x60
AVGG Marvel Noir St. Laurent 60x60
AVA7 Marvel Travertino Alabastrino 60x60
AVGE Marvel Travertino Silver 60x60

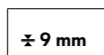

30x60 cm 11³/₄"x23³/₈"
D101 Marvel Statuario Select 30x60
D103 Marvel Crema Delicato 30x60
D105 Marvel Grey Fleury 30x60
D106 Marvel Noir St. Laurent 30x60
D102 Marvel Travertino Alabastrino 30x60
D104 Marvel Travertino Silver 30x60

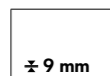

45x90 cm 17³/₄"x35³/₈"
ADKV Marvel Statuario Select 45x90
ADKX Marvel Crema Delicato 45x90
ADKZ Marvel Grey Fleury 45x90
ADK0 Marvel Noir St. Laurent 45x90
ADKW Marvel Travertino Alabastrino 45x90
ADKY Marvel Travertino Silver 45x90

SATIN SURFACE / SUPERFICIE SATINATA

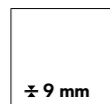

60x60 cm 23³/₈"x23³/₈"
ADV V Marvel Statuario Select 60x60 Satin
AVZ I Marvel Crema Delicato 60x60 Satin
AEDY Marvel Grey Fleury 60x60 Satin
AEDX Marvel Noir St. Laurent 60x60 Satin
AVZ J Marvel Travertino Alabastrino 60x60 Satin
AVZ K Marvel Travertino Silver 60x60 Satin

MATTE SURFACE | SUPERFICIE MATT | Surface Mat | Matt oberfläche | Superficie Mate | Матовая поверхность
SATIN SURFACE | SUPERFICIE SATINATA | Surface satiné | Satiniert oberfläche | Superficie satinado | Сатирированная поверхность
* **WITH FIBERGLASS MESH** | VERSIONE STUOIATA | Version à nattes | Ausführung mit Glasfasermatte | Versión con malla | С упрочнением из стекловолокна
NON RECTIFIED | NON RETTIFICATO | Non rectifié | Nicht rektifiziert | No rectificada | Неретифицированные

MATTE / SATIN



STATUARIO SELECT



CREMA DELICATO

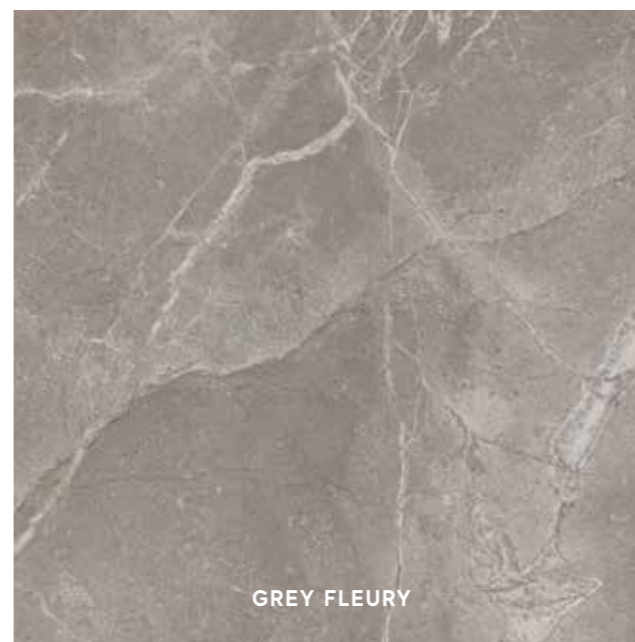

GREY FLEURY

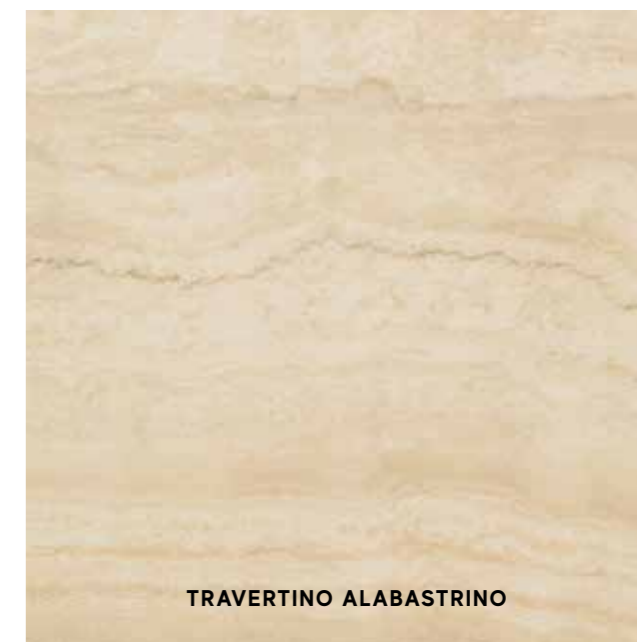

TRAVERTINO ALABASTRINO



NOIR SAINT LAURENT



TRAVERTINO SILVER



V3 MODERATE VARIATION
Statuario Select,
Grey Fleury



V2 SLIGHT VARIATION
Crema Delicato,
Travertino Alabastrino,
Travertino Silver,
Noir St. Laurent

MARBLE LOOK

213



Marvel Pro Porcelain Tiles / Gres Porcellanato

TEXTURED SURFACE / SUPERFICIE STRUTTURATA

± 9 mm

30x60 cm 11³/₄"x23⁵/₈"
D109 Marvel Statuario Select 30x60 Strutturato
D107 Marvel Crema Delicata 30x60 Strutturato
D108 Marvel Grey Fleury 30x60 Strutturato

OUTDOOR PAVING ± 20 mm / PAVIMENTI DA ESTERNO ± 20 mm

± 20 mm

60x60 cm 23⁵/₈"x23⁵/₈"
ADYA Marvel Statuario Select 60x60 LASTRA 20 mm



TEXTURED SURFACE | SUPERFICIE STRUTTURATA | Surface structurée | Strukturiert oberfläche | Superficie estruturado | Структурная поверхность
OUTDOOR PAVING | PAVIMENTI DA ESTERNO | Sols d'extérieur | Außenbeläge für Außenbereiche | Pavimentos para exteriores | Уличная плитка

TEXTURED / OUTDOOR PAVING ± 20 mm



STATUARIO SELECT

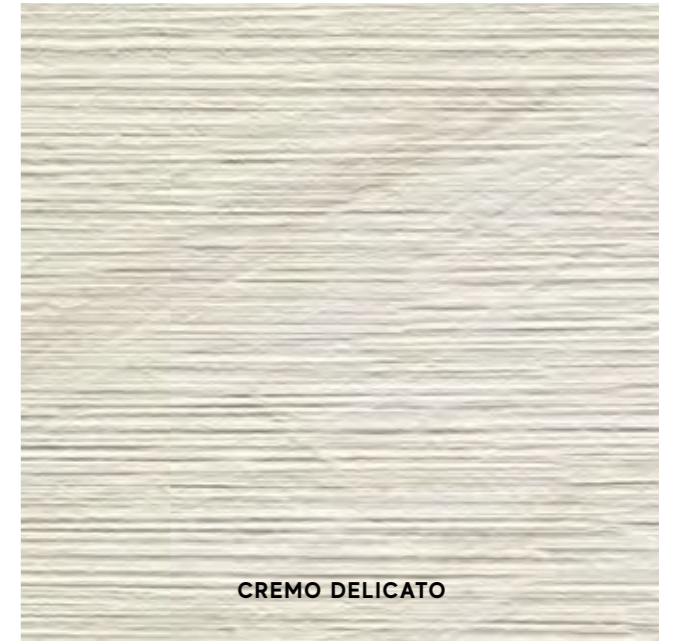

CREMA DELICATO



GREY FLEURY



**V3
MODERATE
VARIATION**
Statuario Select,
Grey Fleury



**V2
SLIGHT
VARIATION**
Crema Delicata

Marvel Pro Porcelain Tiles / Gres Porcellanato

DECOR RANGE / GAMMA DECORI

MARBLE LOOK

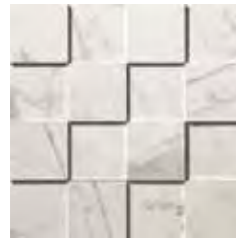

ADP6 Marvel Statuario Select Mosaico 3D *
30x30 - 11³/₄"x11³/₄"



ADQA Marvel Grey Fleury Mosaico 3D *
30x30 - 11³/₄"x11³/₄"



ADQB Marvel Noir St. Laurent Mosaico 3D *
30x30 - 11³/₄"x11³/₄"

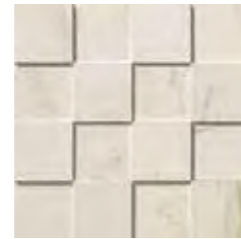

ADP8 Marvel Crema Delicato Mosaico 3D *
30x30 - 11³/₄"x11³/₄"



ADP7 Marvel Travertino Alabastrino Mosaico 3D *
30x30 - 11³/₄"x11³/₄"



ADP9 Marvel Travertino Silver Mosaico 3D *
30x30 - 11³/₄"x11³/₄"



ADQI Marvel Statuario Select Mosaico Matt
30x30 - 11³/₄"x11³/₄"

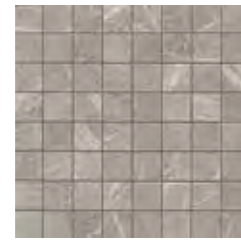

ADQM Marvel Grey Fleury Mosaico Matt
30x30 - 11³/₄"x11³/₄"

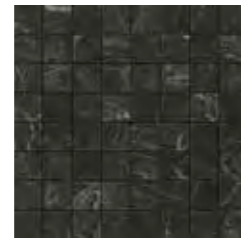

ADQN Marvel Noir St. Laurent Mosaico Matt
30x30 - 11³/₄"x11³/₄"



ADQK Marvel Crema Delicato Mosaico Matt
30x30 - 11³/₄"x11³/₄"



ADQJ Marvel Travertino Alabastrino Mosaico Matt
30x30 - 11³/₄"x11³/₄"



ADQL Marvel Travertino Silver Mosaico Matt
30x30 - 11³/₄"x11³/₄"



ADQC Marvel Statuario Select Mosaico Lappato
30x30 - 11³/₄"x11³/₄"

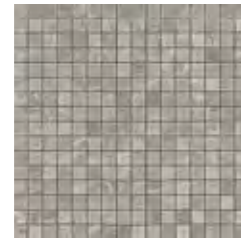

ADQG Marvel Grey Fleury Mosaico Lappato
30x30 - 11³/₄"x11³/₄"

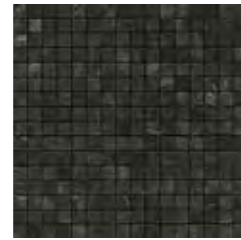

ADQH Marvel Noir St. Laurent Mosaico Lappato
30x30 - 11³/₄"x11³/₄"



ADQE Marvel Crema Delicato Mosaico Lappato
30x30 - 11³/₄"x11³/₄"



ADQD Marvel Travertino Alabastrino Mosaico Lappato
30x30 - 11³/₄"x11³/₄"

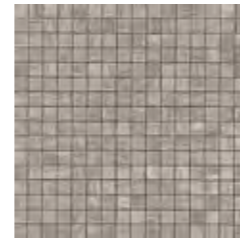

ADQF Marvel Travertino Silver Mosaico Lappato
30x30 - 11³/₄"x11³/₄"



ADVA Marvel Mosaico Honeycomb Cold Lappato
30x49 - 11³/₄"x19¹/₄"
Statuario Select + Noir St. Laurent



ADVB Marvel Mosaico Honeycomb Warm Lappato
30x49 - 11³/₄"x19¹/₄"
Crema Delicato + Noir St. Laurent



ADU9 Marvel Mosaico Circle Lappato
30x30 - 11³/₄"x11³/₄"
Crema Delicato + Noir St. Laurent

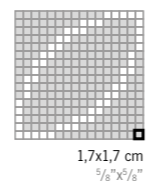
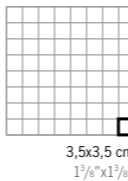
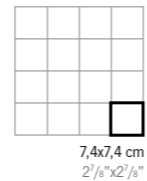

ADRJ Marvel Noir/Crema Greca Mosaico
18,5x30 - 7¹/₄"x11³/₄"
Crema Delicato + Noir St. Laurent

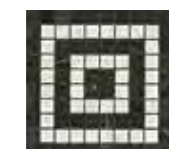

ADRI Marvel Noir/Crema Angolo Mosaico
18,5x18,5 - 7¹/₄"x 7¹/₄"

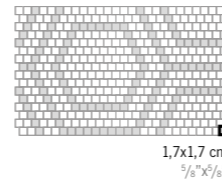
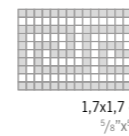
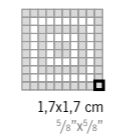

ADVK Marvel Statuario Select Mosaico Esagono Lappato
30x35 - 11³/₄"x13³/₄"



ADVO Marvel Grey Fleury Mosaico Esagono Lappato
30x35 - 11³/₄"x13³/₄"



ADVP Marvel Noir St. Laurent Mosaico Esagono Lappato
30x35 - 11³/₄"x13³/₄"



ADVQ Marvel Mosaico Esagono Multicolor Cold
30x35 - 11³/₄"x13³/₄"
Statuario Select + Grey Fleury + Noir St. Laurent

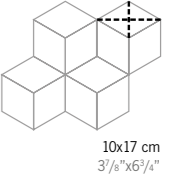

ADVM Marvel Crema Delicato Mosaico Esagono Lappato
30x35 - 11³/₄"x13³/₄"



ADVL Marvel Travertino Alabastrino Mosaico Esagono Lappato
30x35 - 11³/₄"x13³/₄"



ADVN Marvel Travertino Silver Mosaico Esagono Lappato
30x35 - 11³/₄"x13³/₄"



ADVR Marvel Mosaico Esagono Multicolor Warm
30x35 - 11³/₄"x13³/₄"
Crema Delicato + Travertino Alabastrino + Noir St. Laurent



AD5J Marvel Statuario Select Listello 7x75 Lappato
7x75 - 2³/₄"x29¹/₂"

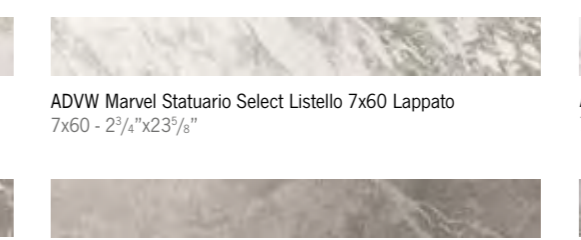

ADVW Marvel Statuario Select Listello 7x60 Lappato
7x60 - 2³/₄"x23³/₈"

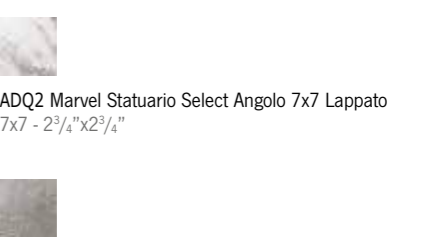

ADQ2 Marvel Statuario Select Angolo 7x7 Lappato
7x7 - 2³/₄"x2³/₄"



AD5N Marvel Grey Fleury Listello 7x75 Lappato
7x75 - 2³/₄"x29¹/₂"

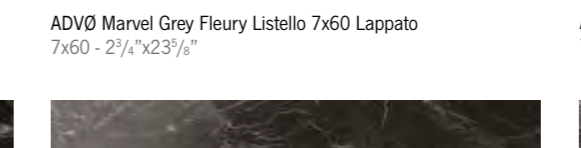

ADVØ Marvel Grey Fleury Listello 7x60 Lappato
7x60 - 2³/₄"x23³/₈"

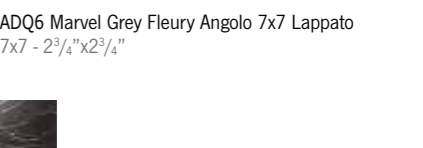

ADQ6 Marvel Grey Fleury Angolo 7x7 Lappato
7x7 - 2³/₄"x2³/₄"



AD5O Marvel Noir St. Laurent Listello 7x75 Lappato
7x75 - 2³/₄"x29¹/₂"



ADV2 Marvel Noir St. Laurent Listello 7x60 Lappato
7x60 - 2³/₄"x23³/₈"

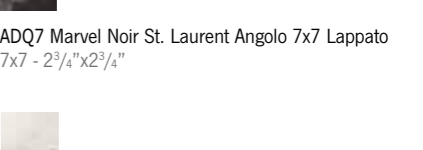

ADQ7 Marvel Noir St. Laurent Angolo 7x7 Lappato
7x7 - 2³/₄"x2³/₄"



AD5L Marvel Crema Delicato Listello 7x75 Lappato
7x75 - 2³/₄"x29¹/₂"



ADVY Marvel Crema Delicato Listello 7x60 Lappato
7x60 - 2³/₄"x23³/₈"

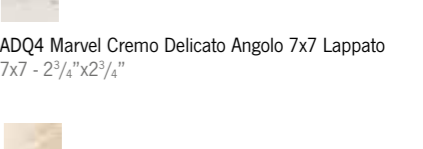

ADQ4 Marvel Crema Delicato Angolo 7x7 Lappato
7x7 - 2³/₄"x2³/₄"

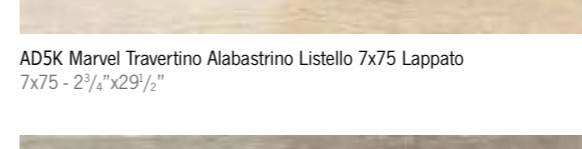

AD5K Marvel Travertino Alabastrino Listello 7x75 Lappato
7x75 - 2³/₄"x29¹/₂"

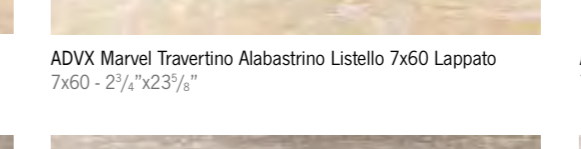

ADVX Marvel Travertino Alabastrino Listello 7x60 Lappato
7x60 - 2³/₄"x23³/₈"

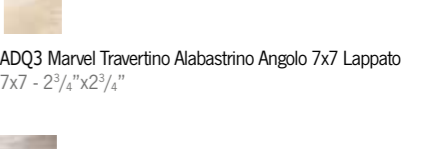

ADQ3 Marvel Travertino Alabastrino Angolo 7x7 Lappato
7x7 - 2³/₄"x2³/₄"



AD5M Marvel Travertino Silver Listello 7x75 Lappato
7x75 - 2³/₄"x29¹/₂"



ADVZ Marvel Travertino Silver Listello 7x60 Lappato
7x60 - 2³/₄"x23³/₈"

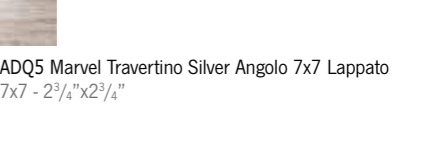

ADQ5 Marvel Travertino Silver Angolo 7x7 Lappato
7x7 - 2³/₄"x2³/₄"

• **MULTI-THICKNESS MOSAIC, CLOSE JOINT INSTALLATION WITHOUT GROUTING.**
MOSAICO MULTISPESSORE, POSA SENZA STUCCATURA A GIUNTO UNITO.
Mosaïque multi-épaisseur, pose sans mastic avec joint nul.
Mosaik mit verschiedenen Stärken, fugenlose Verlegung ohne Mörtel.
Mosaico multiespesor, colocación sin mástique y sin juntas.
Мозаика разной толщины; укладка встык без затирки швов.

MARBLE LOOK

Marvel Pro Porcelain Tiles / Gres Porcellanato

DECOR RANGE / GAMMA DECORI

MARBLE LOOK



AD5F Marvel Statuario Select Macchia Aperta Lappato A - 75x150 - 29 1/2"x59"



AD5G Marvel Statuario Select Macchia Aperta Lappato B - 75x150 - 29 1/2"x59"



AD5H Marvel Grey Fleury Macchia Aperta Lappato A - 75x150 - 29 1/2"x59"



AD5I Marvel Grey Fleury Macchia Aperta Lappato B - 75x150 - 29 1/2"x59"

THE MINIATURES ARE NOT IN PROPORTION.
I MINIMALI NON SONO IN PROPORZIONE.
Les illustrations à échelle réduite ne sont pas proportionnelles.
Die Abbildungen sind nicht verhältnismäßig.
Los miniaturas no están en proporción. n.
Изображения не соблюдают пропорций.

In order to obtain a symmetrical open book installation pattern as reported in the charts below, it is necessary to lay an equal number of tiles of type A and B / Per ottenere la posa simmetrica a macchia aperta riportata negli schemi di posa sottostanti occorre posare un numero uguale di piastrelle di tipo A e di tipo B / Pour obtenir la pose symétrique à livre ouvert indiquée dans les schémas de pose ci-dessous, il est nécessaire de poser une quantité identique de carreaux de type A et de type B / Für die symmetrische bildfurnierte Verlegung, wie im Verlegeschema dargestellt, muss man die gleiche Anzahl von Fliesen vom Typ A und Typ B verlegen / Para obtener la colocación a libro abierto mostrada en los esquemas de colocación de abajo hay que colocar el mismo número de baldosas de tipo A y de tipo B / Для получения симметричного зеркального рисунка укладки, приведенного на схемах ниже, необходимо уложить одинаковое число плиток типа А и типа В



Layout 1 *

Layout 2 *

Layout 3 *

Layout 4 *

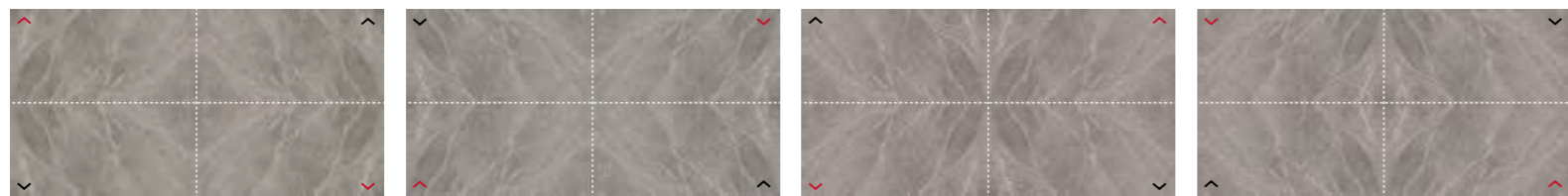

Layout 1 *

Layout 2 *

Layout 3 *

Layout 4 *

*** THE MINIATURES OF THE MULTIFORMATO MODULE ARE NOT IN PROPORTION.**
I MINIMALI NEL MODULO MULTIFORMATO NON SONO IN PROPORZIONE.
Les illustrations à échelle réduite dans le Module Multiformato ne sont pas proportionnelles.
Die Abbildungen im Modul Multiformato sind nicht verhältnismäßig.
Los miniaturas en el Módulo Multiformato no están en proporción.
Изображения Multiformato модуля не соблюдают пропорций.



ADVT Marvel Elegance Angolo Dark * ▲
60x60 - 23 5/8"x23 5/8"



ADVU Marvel Elegance Fascia Dark ▲
60x60 - 23 5/8"x23 5/8"

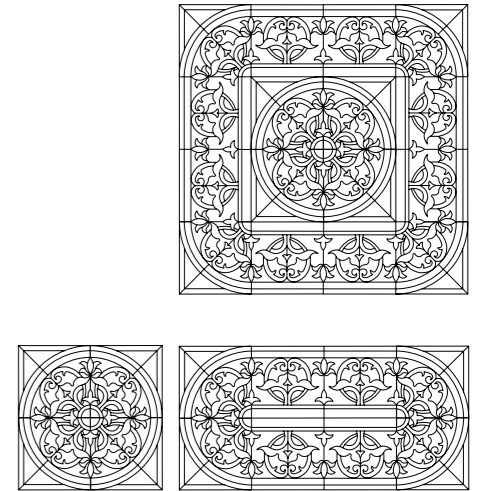

Crema Delicato + Travertino Alabastrino + Grey Fleury + Noir St. Laurent



AD5T Marvel Noir St. Laurent Listello Esagono Lappato
11x86 - 4 3/8"x33 7/8"



AD5Q Etic Rovere Listello Esagono
11x86 - 4 3/8"x33 7/8"



AD5R Etic Noce Listello Esagono
11x86 - 4 3/8"x33 7/8"



▲ **NOT MATCHING WITH SIZES 59x59 CM, 29,5x59 CM.**
NON ABBINABILE AI FORMATI 59x59 CM, 29,5x59 CM.
Ne peut être assorti aux formats 59x59 cm, 29,5x59 cm.
Nicht mit den Formaten 59x59 cm, 29,5x59 cm kombinierbar.
No combinable con los formatos 59x59 cm, 29,5x59 cm.
Не сочетается с форматами 59x59 см, 29,5x59 см.

● **TO BE ORDERED IN MULTIPLES OF 4.**
ORDINABILE IN MULTIPLI DI 4.
Peut être commandé en multiples de 4.
Zum Bestellen als Vielfache von 4.
Es posible efectuar pedidos en múltiplos de 4.
Заказываются в количестве кратном 4.

AD3J Etic Listello Pallissandro Esagono
11x86 - 4 3/8"x33 7/8"

TRIM TILES / PEZZI SPECIALI
p. 424

	Battiscopa 7,2x60 2 7/8"x23 5/8"		Battiscopa Lappato 7,2x60 2 7/8"x23 5/8"		Gradino * 30x60 11 3/4"x23 5/8"		Scalino * 33x90 13"x35 5/8"		Scalino * 33x60 13"x23 5/8"		Scalino Angolare 33x33 - 13"x13"		Battiscopa Sag. Scala 7,2x30 - 2 7/8"x11 3/4"		Elemento L Str. * 15x60 H. 4 5 7/8"x23 5/8" H. 1 5/8"	
	DX *	SX *	DX *	SX *	DX *	SX *	DX *	SX *	DX *	SX *	DX *	SX *	DX *	SX *		
Statuario Select	ADV3	ADV9	ADW5	ADXB	ADXH	ADXQ	ADXY	ADXZ	ADYD							
Crema Delicato	ADV5	ADWB	ADW7	ADXD	ADXJ	ADXR	ADX2	ADX3	ADYE							
Travertino Alabastrino	ADV4	ADWA	ADW6	ADXC	ADXI	ADXU	AD XV	ADXØ	ADX1	-						
Travertino Silver	ADV6	ADWC	ADW8	ADXE	AD XK	AD XW	AD XX	ADX4	ADX5	-						
Grey Fleury	ADV7	ADWD	ADW9	ADXF	AD XL	AD XS	ADX6	ADX7	AD YF							
Noir St. Laurent	ADV8	ADWE	ADXA	ADXG	AD XM	AD XT	ADX8	ADX9	-							

* THESE PARTS ARE SUPPLIED TO ORDER | I PEZZI SONO DISPONIBILI SU ORDINAZIONE | Les pièces sont disponibles sur commande | Die Teile sind auf Bestellung lieferbar | Las piezas se hacen por encargo | Изготавливаются на заказ

MARBLE LOOK

219



Marvel Pro Wall Tiles / Rivestimento

WALL TILES p. 516

SHINY SURFACE / SUPERFICIE LUCIDA

3D WALL TILES / RIVESTIMENTO 3D

± 8,5 mm

50x110 cm 19⁵/₈"x43¹/₄"
4MPT Marvel Statuario Select 50x110
4MPN Marvel Noir St. Laurent 50x110
4MPE Marvel Crema Delicato 50x110

± 10 mm

40x80 cm 15³/₄"x31¹/₂"
9MSS Marvel Statuario Select Ribbon
9MSR Marvel Crema Delicato Ribbon
9MSG Marvel Grey Fleury Ribbon
9MSN Marvel Noir St. Laurent Ribbon

± 8,5 mm

40x80 cm 15³/₄"x31¹/₂"
9M4R Marvel Statuario Select 40x80
9M4E Marvel Crema Delicato 40x80
9M4F Marvel Grey Fleury 40x80
9M4L Marvel Travertino Alabastrino 40x80
9M4O Marvel Noir St. Laurent 40x80
9M4Q Marvel Travertino Silver 40x80

± 8,5 mm

30,5x91,5 cm 12"x36"
9M3S Marvel Statuario Select 91
9M3G Marvel Grey Fleury 91
9M3N Marvel Noir St. Laurent 91
9M3C Marvel Crema Delicato 91
9M3T Marvel Travertino Alabastrino 91
9M3V Marvel Travertino Silver 91

± 8,5 mm

8x31,5 3¹/₈"x12³/₈"
LMKT Marvel Statuario Select Brick
LMKN Marvel Noir S. Laurent Brick

DECORATIVE RANGE / GAMMA DECORATIVA

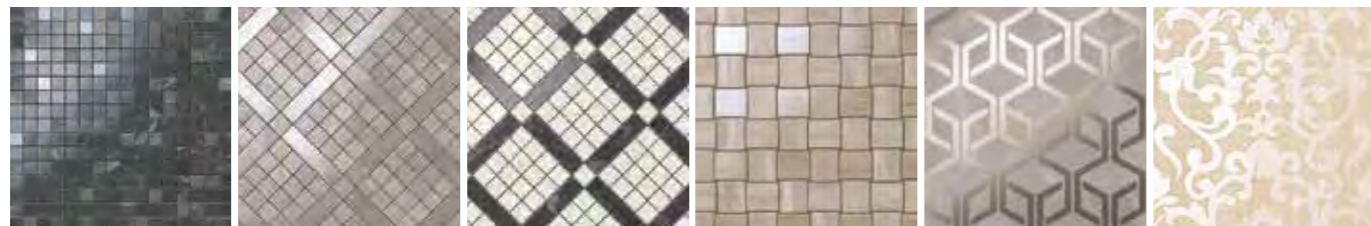

MOSAIC

DIAGONAL MOSAIC

MIX DIAGONAL MOSAIC

NET MOSAIC

HEXAGON

BROCADE

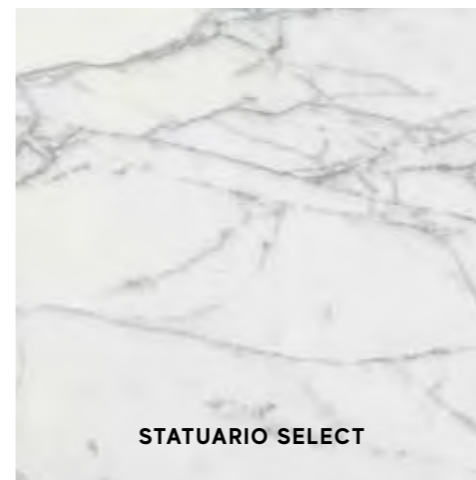

STATUARIO SELECT

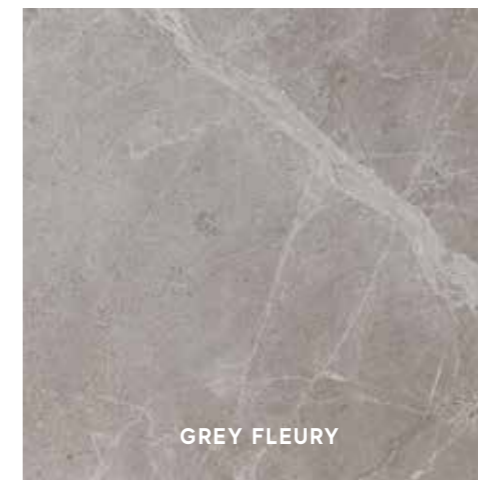

GREY FLEURY



NOIR ST. LAURENT



CREMA DELICATO



TRAVERTINO ALABASTRINO



TRAVERTINO SILVER



3D RIBBON
STATUARIO SELECT

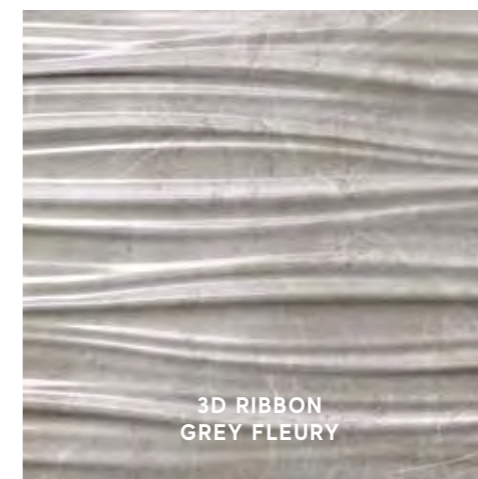

3D RIBBON
GREY FLEURY



3D RIBBON
CREMA DELICATO



3D RIBBON
NOIR ST. LAURENT



**V3
MODERATE
VARIATION**
Statuario Select,
Grey Fleury



**V2
SLIGHT
VARIATION**
Crema Delicato,
Travertino Alabastrino,
Travertino Silver,
Noir St. Laurent



MARVEL

STONE

PORCELAIN&WALL TILES

Porcelain Tiles / Gres Porcellanato

COLOURED BODY PORCELAIN TILES - RECTIFIED MONOCALIBER
GRES PORCELLANATO COLORATO IN MASSA - RETTIFICATO MONOCALIBRO

LARGE SIZES p. 366

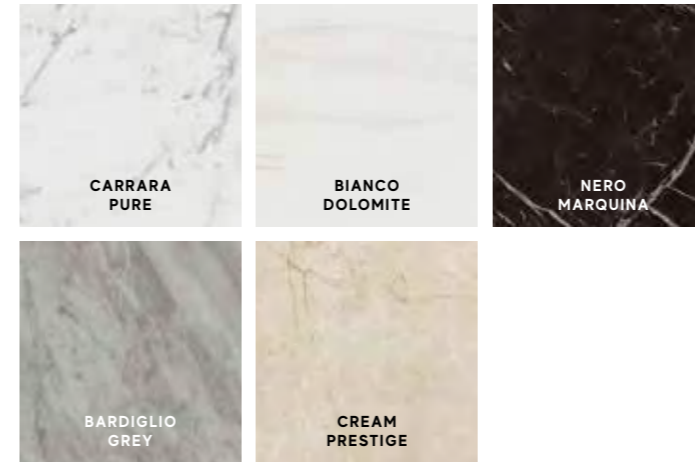

Sizes	Thickness	Surface finish
162x324 cm - 63 ³ / ₄ "x127 ¹ / ₂ " ▶ NON RECTIFIED - NON RETTIFICATO	± 6-12-20 mm	Lappato Lux I Silk
160x320 cm - 63"x126"	± 6 mm	Polished
160x160 cm - 63"x63"	± 6 mm	Polished
120x278 cm - 47 ¹ / ₄ "x109 ¹ / ₂ "	± 6 mm	Polished I Matte R9 A
120x240 cm - 47 ¹ / ₄ "x94 ¹ / ₂ "	± 9 mm	Polished
120x120 cm - 47 ¹ / ₄ "x47 ¹ / ₄ "	± 9 mm	Polished I Matte R9 A
60x120 cm - 23 ⁵ / ₈ "x47 ¹ / ₄ "	± 9 mm	Polished I Matte R9 A
75x150 cm - 29 ¹ / ₂ "x59"	± 9 mm	Polished
75x75 cm - 29 ¹ / ₂ "x29 ¹ / ₂ "	± 9 mm	Polished
45x90 cm - 17 ³ / ₄ "x35 ³ / ₈ "	± 9 mm	Polished I Matte R9 A
60x60 cm - 23 ⁵ / ₈ "x23 ⁵ / ₈ "	± 9 mm	Polished I Matte R9 A
30x60 cm - 11 ³ / ₄ "x23 ⁵ / ₈ "	± 9 mm	Polished I Matte R9 A

MARVEL STONE COLLECTION
STONE LOOK p. 280

Wall Tiles / Rivestimento p. 524

WHITEBODY WALL TILES - RECTIFIED MONOCALIBER
RIVESTIMENTI IN PASTA BIANCA - RETTIFICATO MONOCALIBRO

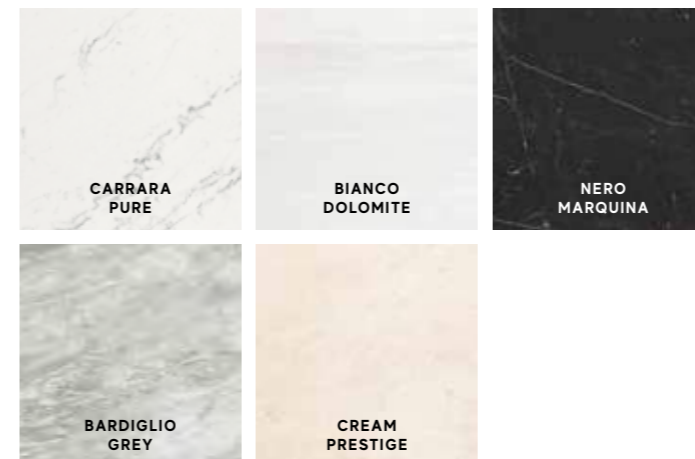

Sizes	Thickness	Surface finish
50x110 cm - 19 ⁵ / ₈ "x43 ¹ / ₄ "	± 8,5 mm	Shiny
40x80 cm - 15 ³ / ₄ "x31 ¹ / ₂ "	± 8,5 mm	Shiny

COLOURED BODY PORCELAIN TILES | GRES PORCELLANATO COLORATO IN MASSA | Grès cérame coloré dans la masse | Durchgefärbtes Feinsteinzeug | Gres porcelánico coloreado en masa | Керамический гранит окрашенный в массу
WHITEBODY WALL TILES | RIVESTIMENTI IN PASTA BIANCA | Revêtements en pâte blanche | Weißscherbige Wandfliesen | Revestimientos en pasta blanca | Настенная плитка из белой глины
RECTIFIED MONOCALIBER | RETTIFICATO MONOCALIBRO | Rectifié mono-calibre | Geschliffen einkalibrig | Rectificado monocalibre | Ретифицированный в одном калибре
NON RECTIFIED | NON RETTIFICATO | Non rectifié | Nicht rektifiziert | No rectificada | Неретифицированные



Marvel Stone Porcelain Tiles / Gres Porcellanato

POLISHED SURFACE / SUPERFICIE LAPPATA



160x320 cm 63"x126"
A05X Marvel Bianco Dolomite 160x320RT Lappato

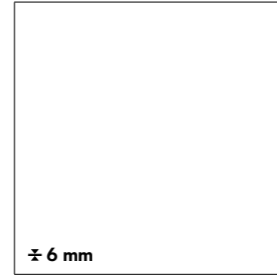

160x160 cm 63"x63"
A053 Marvel Bianco Dolomite 160x160RT Lappato



LAPPATO LUX
162x324 cm 63³/₄"x127¹/₂"
> **NON RECTIFIED** / NON RETTIFICATO
AAVO Bianco Dolomite A Lap Lux ± 12 mm
AAVG Bianco Dolomite A Lap Lux ± 12 mm ST *
ANV9 Nero Marquina Lap Lux ± 12 mm
ANWA Nero Marquina Lap Lux ± 12 mm ST *



120x278 cm 47¹/₄"x109¹/₂"
A0BP Marvel Bianco Dolomite 120x278 Lappato
A2RW Marvel Carrara Pure 120x278 Lappato



120x240 cm 47¹/₄"x94¹/₂"
AZTV Marvel Bianco Dolomite 120x240 Lappato
AZTW Marvel Carrara Pure 120x240 Lappato

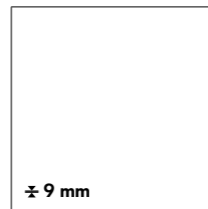

120x120 cm 47¹/₄"x47¹/₄"
AZTT Marvel Bianco Dolomite 120x120 Lappato
AZTU Marvel Carrara Pure 120x120 Lappato

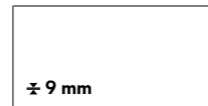

60x120 cm 23⁵/₈"x47¹/₄"
A21K Marvel Bianco Dolomite 60x120 Lappato
AKS0 Marvel Carrara Pure 60x120 Lappato

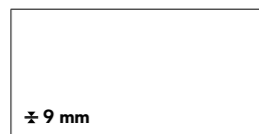

75x150 cm 29¹/₂"x59"
AZNB Marvel Bianco Dolomite 75x150 Lappato
AZNC Marvel Cream Prestige 75x150 Lappato
AZND Marvel Bardiglio Grey 75x150 Lappato
AZNE Marvel Carrara Pure 75x150 Lappato
AZNF Marvel Nero Marquina 75x150 Lappato

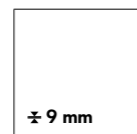

75x75 cm 29¹/₂"x29¹/₂"
AZNH Marvel Bianco Dolomite 75x75 Lappato
AZNI Marvel Cream Prestige 75x75 Lappato
AZNJ Marvel Bardiglio Grey 75x75 Lappato
AZNK Marvel Carrara Pure 75x75 Lappato
AZNL Marvel Nero Marquina 75x75 Lappato

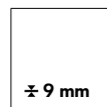

60x60 cm 23⁵/₈"x23⁵/₈"
AZRI Marvel Bianco Dolomite 60x60 Lappato
AZRJ Marvel Cream Prestige 60x60 Lappato
AZRK Marvel Bardiglio Grey 60x60 Lappato
AZRL Marvel Carrara Pure 60x60 Lappato
AZRM Marvel Nero Marquina 60x60 Lappato

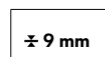

30x60 cm 11³/₄"x23⁵/₈"
D039 Marvel Bianco Dolomite 30x60 Lappato
D040 Marvel Cream Prestige 30x60 Lappato
D041 Marvel Bardiglio Grey 30x60 Lappato
D044 Marvel Carrara Pure 30x60 Lappato
D045 Marvel Nero Marquina 30x60 Lappato



45x90 cm 17³/₄"x35⁵/₈"
AZRU Marvel Bianco Dolomite 45x90 Lappato
AZRV Marvel Cream Prestige 45x90 Lappato
AZRW Marvel Bardiglio Grey 45x90 Lappato
AZRX Marvel Carrara Pure 45x90 Lappato
AZRY Marvel Nero Marquina 45x90 Lappato

The glossy polished finish is suitable for residential or low-traffic commercial floors, where no anti-slip performance is required, and for walls. The polished glossy surface finish, surprisingly brilliant and bright, features slight irregularities typical of natural marble. The extraordinary brilliance and the easy cleaning of the surface are the result of in-depth research aimed at guaranteeing its durability over time. - If the product is in direct contact with the outdoors, provide devices for absorbing moisture and dirt to prevent scratches. / La finitura lappata lucida è indicata per pavimenti residenziali o commerciali poco sollecitati, laddove non siano richieste prestazioni antiscivolo, e per rivestimenti. La finitura lappata lucida offre una superficie sorprendentemente brillante e specchiante, con lievi irregolarità tipiche dei marmi naturali. La straordinaria lucentezza e l'elevata pulibilità della superficie sono frutto di studi approfonditi e accurate ricerche tecniche volte a garantirne la persistenza nel tempo. - Se il prodotto è a diretto contatto con l'esterno, prevedere dei dispositivi di assorbimento dell'umidità e della sporcizia per prevenire la formazione di graffi.

POLISHED SURFACE | SUPERFICIE LAPPATA | Surface adouci | Geläppte Oberfläche | Superficie bruñido | Полиполированный поверхность

* **WITH FIBERGLASS MESH** | VERSIONE STUOIATA | Version à nattes | Ausführung mit Glasfasermatte | Versión con malla | С упрочнением из стекловолоконна
NON RECTIFIED | NON RETTIFICATO | Non rectifié | Nicht rektifiziert | No rectificada | Неретифицированные



BIANCO DOLOMITE



CARRARA PURE



CREAM PRESTIGE



BARDIGLIO GREY

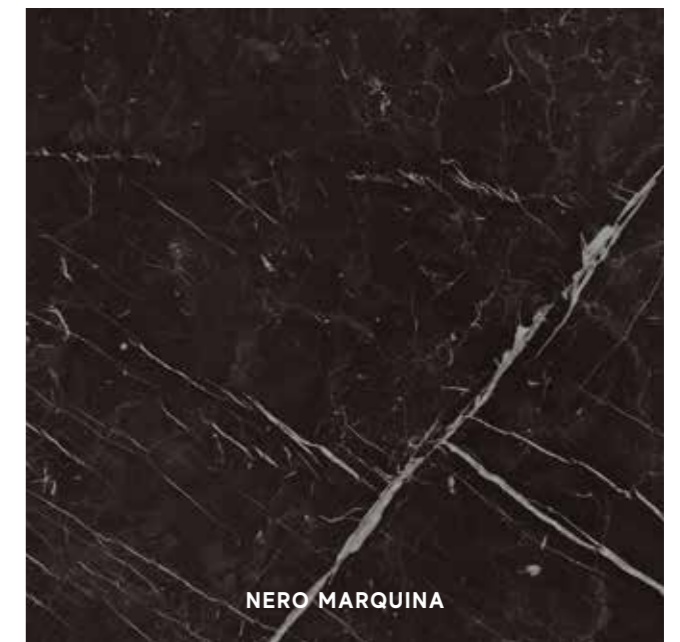

NERO MARQUINA



V2 SLIGHT VARIATION

Carrara Pure, Bardiglio Grey, Nero Marquina, Bianco Dolomite, Cream Prestige



Marvel Stone Porcelain Tiles / Gres Porcellanato

MATTE SURFACE / SUPERFICIE MATT



120x278 cm 47¹/₄"x109¹/₂"
A2RS Marvel Bianco Dolomite 120x278 Matt
A2RV Marvel Carrara Pure 120x278 Matt



SILK
162x324 cm 63³/₄"x127¹/₂"
> **NON RECTIFIED / NON RETTIFICATO**
AAVR Carrara Pure Silk ± 12 mm
AAV3 Carrara Pure Silk ± 12 mm ST *
AAVU Cream Prestige Silk ± 12 mm
AAV6 Cream Prestige Silk ± 12 mm ST *
A07W Nero Marquina Silk ± 6 mm
A07Y Nero Marquina Silk ± 6 mm ST *
ANVJ Nero Marquina Silk ± 12 mm
ANVK Nero Marquina Silk ± 12 mm ST *
AZXT Nero Marquina Silk ± 20 mm

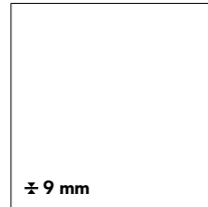

120x120 cm 47¹/₄"x47¹/₄"
A204 Marvel Bianco Dolomite 120x120 Matt
A207 Marvel Carrara Pure 120x120

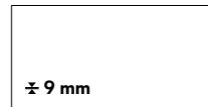

60x120 cm 23⁵/₈"x47¹/₄"
A21C Marvel Bianco Dolomite 60x120
A21E Marvel Carrara Pure 60x120

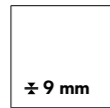

60x60 cm 23⁵/₈"x23⁵/₈"
AZQS Marvel Bianco Dolomite 60x60
AZQT Marvel Cream Prestige 60x60
AZQU Marvel Bardiglio Grey 60x60
AZQV Marvel Carrara Pure 60x60
AZQW Marvel Nero Marquina 60x60

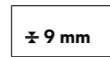

30x60 cm 11³/₄"x23⁵/₈"
D110 Marvel Bianco Dolomite 30x60
D111 Marvel Cream Prestige 30x60
D112 Marvel Bardiglio Grey 30x60
D113 Marvel Carrara Pure 30x60
D114 Marvel Nero Marquina 30x60



45x90 cm 17³/₄"x35⁵/₈"
AZRZ Marvel Bianco Dolomite 45x90
AZR0 Marvel Cream Prestige 45x90
AZR1 Marvel Bardiglio Grey 45x90
AZR3 Marvel Carrara Pure 45x90
AZR4 Marvel Nero Marquina 45x90



BIANCO DOLOMITE

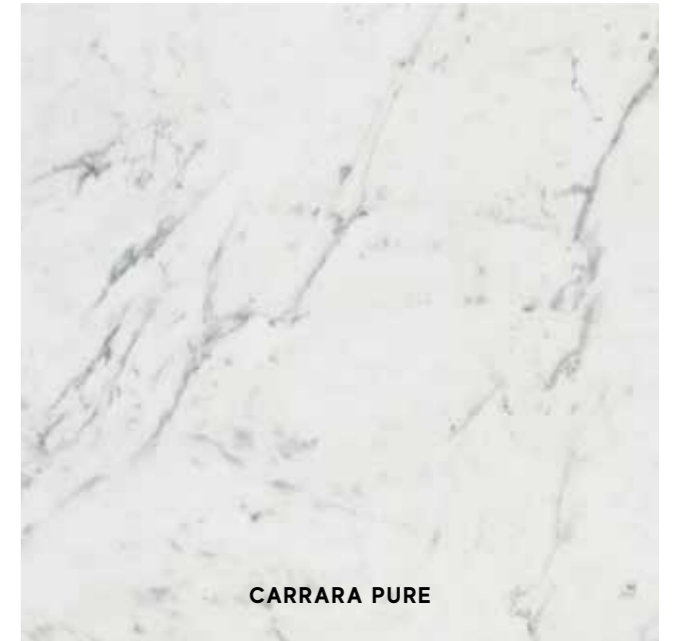

CARRARA PURE



CREAM PRESTIGE



BARDIGLIO GREY

TRIM TILES / PEZZI SPECIALI

p. 424



	Battiscopa		Battiscopa Digitale		Gradino *	Scalino *	Scalino Angolare		Battiscopa Sag. Scala	
	7,2x60 - 2 ⁷ / ₈ "x23 ⁵ / ₈ "		4,6x60 - 1 ³ / ₄ "x23 ⁵ / ₈ "				33x33 - 13"x13"		7,2x30 - 2 ⁷ / ₈ "x11 ³ / ₄ "	
	Matt	Lappato	Matt	Lappato			DX *	SX *	DX *	SX *
Bianco Dolomite	ATDT	ATDO	ATDJ	ATDE	ATDY	ATD3	ATEE	ATD8	ATEO	ATEJ
Cream Prestige	ATDU	ATDP	ATDK	ATDF	ATDZ	ATD4	ATEF	ATD9	ATEP	ATEK
Bardiglio Grey	ATDV	ATDQ	ATDL	ATDG	ATD0	ATD5	ATEG	ATEA	ATEQ	ATEL
Carrara Pure	ATDW	ATDR	ATDM	ATDH	ATD1	ATD6	ATEH	ATEC	ATER	ATEM
Nero Marquina	ATDX	ATDS	ATDN	ATDI	ATD2	ATD7	ATEI	ATED	ATES	ATEN

* THESE PARTS ARE SUPPLIED TO ORDER | I PEZZI SONO DISPONIBILI SU ORDINAZIONE
Les pièces sont disponibles sur commande | Die Teile sind auf Bestellung lieferbar | Las piezas se hacen por encargo | Изготавливаются на заказ

* WITH FIBERGLASS MESH | VERSIONE STUOIATA | Version à nattes | Ausführung mit Glasfasermatte | Versión con malla | С упрочнением из стекловолоконна
MATTE SURFACE | SUPERFICIE MATT | Surface Mat | Matt Oberfläche | Superficie Mate | Матовая поверхность



V2 SLIGHT VARIATION

Carrara Pure, Bardiglio Grey, Nero Marquina, Bianco Dolomite, Cream Prestige

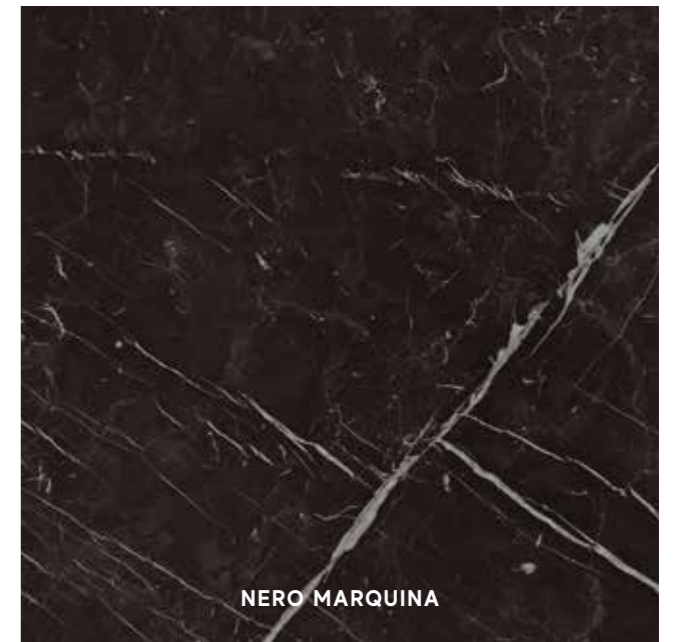

NERO MARQUINA

Marvel Stone Porcelain Tiles / Gres Porcellanato

DECOR RANGE / GAMMA DECORI

MARBLE LOOK



AS2J Marvel Carrara Pure Mosaico Esagono Lappato 30x35 - 11³/₄"x13³/₄"



AS2G Marvel Bianco Dolomite Mosaico Esagono Lappato 30x35 - 11³/₄"x13³/₄"



AS2H Marvel Cream Prestige Mosaico Esagono Lappato 30x35 - 11³/₄"x13³/₄"



AS2I Marvel Bardiglio Grey Mosaico Esagono Lappato 30x35 - 11³/₄"x13³/₄"



AS2K Marvel Nero Marquina Mosaico Esagono Lappato 30x35 - 11³/₄"x13³/₄"

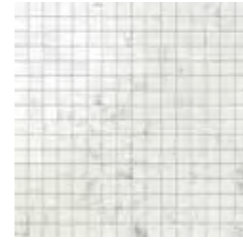

AS3T Marvel Carrara Pure Mosaico Lappato 30x30 - 11³/₄"x11³/₄"

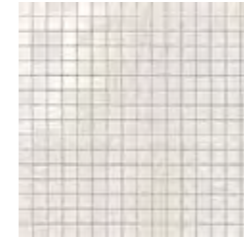

AS2T Marvel Bianco Dolomite Mosaico Lappato 30x30 - 11³/₄"x11³/₄"

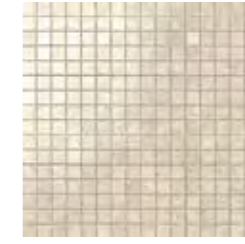

AS3Q Marvel Cream Prestige Mosaico Lappato 30x30 - 11³/₄"x11³/₄"

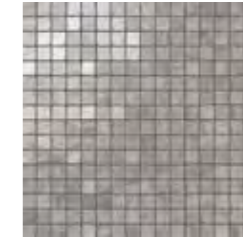

AS3S Marvel Bardiglio Grey Mosaico Lappato 30x30 - 11³/₄"x11³/₄"



AS3U Marvel Nero Marquina Mosaico Lappato 30x30 - 11³/₄"x11³/₄"

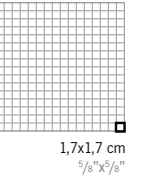

1,7x1,7 cm
2/8"x2/8"



AS1V Marvel Carrara Pure Chevron Lappato 22,5x22,9 - 8³/₄"x9"



AS1Q Marvel Bianco Dolomite Chevron Lappato 22,5x22,9 - 8³/₄"x9"



AS1R Marvel Cream Prestige Chevron Lappato 22,5x22,9 - 8³/₄"x9"



AS1U Marvel Bardiglio Grey Chevron Lappato 22,5x22,9 - 8³/₄"x9"



AS1W Marvel Nero Marquina Chevron Lappato 22,5x22,9 - 8³/₄"x9"



AS2F Marvel Chevron Cold Lappato Carrara Pure + Nero Marquina 22,5x22,9 - 8³/₄"x9"

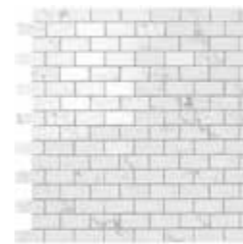

AS34 Marvel Carrara Pure Mosaico Lappato Burattato 29,8x29,8 - 11⁵/₈"x11⁵/₈"



AS31 Marvel Bianco Dolomite Mosaico Lappato Burattato 29,8x29,8 - 11⁵/₈"x11⁵/₈"



AS32 Marvel Cream Prestige Mosaico Lappato Burattato 29,8x29,8 - 11⁵/₈"x11⁵/₈"

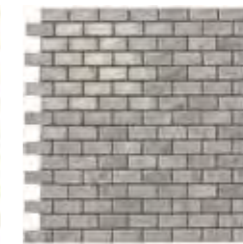

AS33 Marvel Bardiglio Grey Mosaico Lappato Burattato 29,8x29,8 - 11⁵/₈"x11⁵/₈"

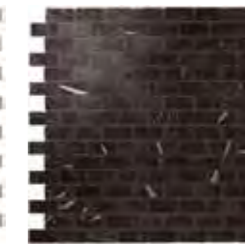

AS35 Marvel Nero Marquina Mosaico Lappato Burattato 29,8x29,8 - 11⁵/₈"x11⁵/₈"

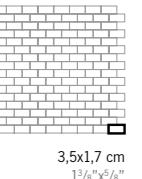

3,5x1,7 cm
1⁷/₈"x2/8"



AS4A Marvel Carrara Pure Mosaico Esagono 3D 28,2x35,3 - 11"x14"



AS36 Marvel Bianco Dolomite Mosaico Esagono 3D 28,2x35,3 - 11"x14"



AS38 Marvel Cream Prestige Mosaico Esagono 3D 28,2x35,3 - 11"x14"



AS39 Marvel Bardiglio Grey Mosaico Esagono 3D 28,2x35,3 - 11"x14"



AS4B Marvel Nero Marquina Mosaico Esagono 3D 28,2x35,3 - 11"x14"

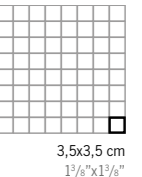

3,5x3,5 cm
1³/₈"x1³/₈"



AS2L Marvel Mosaico Esagono Geo Cold Lappato Carrara Pure + Bardiglio Grey + Nero Marquina 25,4x35,2 - 10"x13³/₄"



AS2M Marvel Mosaico Esagono Geo Warm Lappato Bianco Dolomite + Cream Prestige + Nero Marquina 25,4x35,2 - 10"x13³/₄"

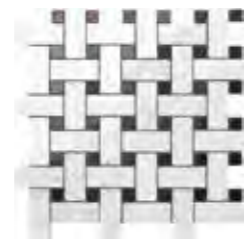

AS2O Marvel Basketweave Cold Lappato Carrara Pure + Nero Marquina 30x30 - 11³/₄"x11³/₄"



AS2P Marvel Basketweave Warm Lappato Cream Prestige + Nero Marquina 30x30 - 11³/₄"x11³/₄"



AS4W Marvel Carrara Pure Listello Lappato 7x60 - 2³/₄"x23³/₈"



AS4T Marvel Bianco Dolomite Listello Lappato 7x60 - 2³/₄"x23³/₈"



AS4U Marvel Cream Prestige Listello Lappato 7x60 - 2³/₄"x23³/₈"



AS4V Marvel Bardiglio Grey Listello Lappato 7x60 - 2³/₄"x23³/₈"



AS4X Marvel Nero Marquina Listello Lappato 7x60 - 2³/₄"x23³/₈"



AS41 Marvel Carrara Pure Angolo Lappato 7x7 - 2³/₄"x2³/₄"



AS4Y Marvel Bianco Dolomite Angolo Lappato 7x7 - 2³/₄"x2³/₄"



AS4Z Marvel Cream Prestige Angolo Lappato 7x7 - 2³/₄"x2³/₄"



AS4Ø Marvel Bardiglio Grey Angolo Lappato 7x7 - 2³/₄"x2³/₄"



AS42 Marvel Nero Marquina Angolo Lappato 7x7 - 2³/₄"x2³/₄"



AMMS Marvel Half Hex Cold Lappato Carrara Pure + Nero Marquina 33x48,3 - 13"x19"

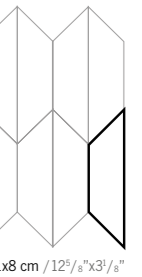

32,1x8 cm / 12⁵/₈"x3¹/₈"

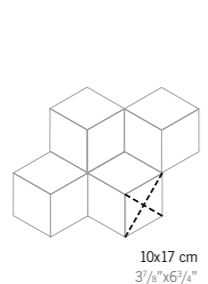

10x17 cm
3¹/₈"x6⁷/₈"

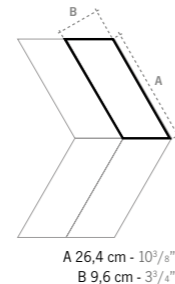

A 26,4 cm - 10³/₈"
B 9,6 cm - 3⁷/₈"

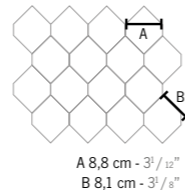

A 8,8 cm - 3¹/₂"
B 8,1 cm - 3¹/₈"

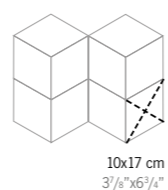

10x17 cm
3¹/₈"x6⁷/₈"

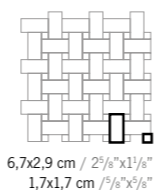

6,7x2,9 cm / 2⁵/₈"x1¹/₈"
1,7x1,7 cm / 2/8"x2/8"

MARBLE LOOK



Marvel Stone Wall Tiles / Rivestimento

WALL TILES p. 524

SHINY SURFACE / SUPERFICIE LUCIDA

± 8,5 mm

± 8,5 mm

50x110 cm 19⁵/₈"x43¹/₂"
 AZOQ Marvel Carrara Pure 110
 AZOR Marvel Bianco Dolomite 110
 AZOS Marvel Cream Prestige 110
 AZOT Marvel Bardiglio Grey 110
 AZOU Marvel Nero Marquina 110

40x80 cm 15³/₄"x31¹/₂"
 9MSF Marvel Carrara Pure 40x80
 9MSB Marvel Bianco Dolomite 40x80
 9MSI Marvel Cream Prestige 40x80
 9MSD Marvel Bardiglio Grey 40x80
 9MSM Marvel Nero Marquina 40x80

TRIM TILES / PEZZI SPECIALI



 LSLH Marvel Carrara Pure London
 5x30,5 cm - 2"x12"

 ALSF Marvel Carrara Pure London A.E.
 5x2,5 cm - 2"x1"



 LSLM Marvel Bianco Dolomite London
 5x30,5 cm - 2"x12"



 ALSD Marvel Bianco Dolomite London A.E.
 5x2,5 cm - 2"x1"



 LSSA Marvel Carrara Pure Spigolo
 0,8x20 cm - 3¹/₈"x7⁷/₈"



 AS1A Marvel Carrara Pure Spigolo A.E.
 0,8x0,8 cm - 3¹/₈"x3¹/₈"



 LSSD Marvel Bianco Dolomite Spigolo
 0,8x20 cm - 3¹/₈"x7⁷/₈"



 AS1D Marvel Bianco Dolomite Spigolo A.E.
 0,8x0,8 cm - 3¹/₈"x3¹/₈"



 LSLE Marvel Cream Prestige London
 5x30,5 cm - 2"x12"

 ALSE Marvel Cream Prestige London A.E.
 5x2,5 cm - 2"x1"



 LSLO Marvel Bardiglio Grey London
 5x30,5 cm - 2"x12"

 ALSG Marvel Bardiglio Grey London A.E.
 5x2,5 cm - 2"x1"



 LSSE Marvel Cream Prestige Spigolo
 0,8x20 cm - 3¹/₈"x7⁷/₈"



 AS1E Marvel Cream Prestige Spigolo A.E.
 0,8x0,8 cm - 3¹/₈"x3¹/₈"



 LSSB Marvel Bardiglio Grey Spigolo
 0,8x20 cm - 3¹/₈"x7⁷/₈"

 AS1G Marvel Bardiglio Grey Spigolo A.E.
 0,8x0,8 cm - 3¹/₈"x3¹/₈"



 LSLN Marvel Nero Marquina London
 5x30,5 cm - 2"x12"

 ALSN Marvel Nero Marquina London A.E.
 5x2,5 cm - 2"x1"

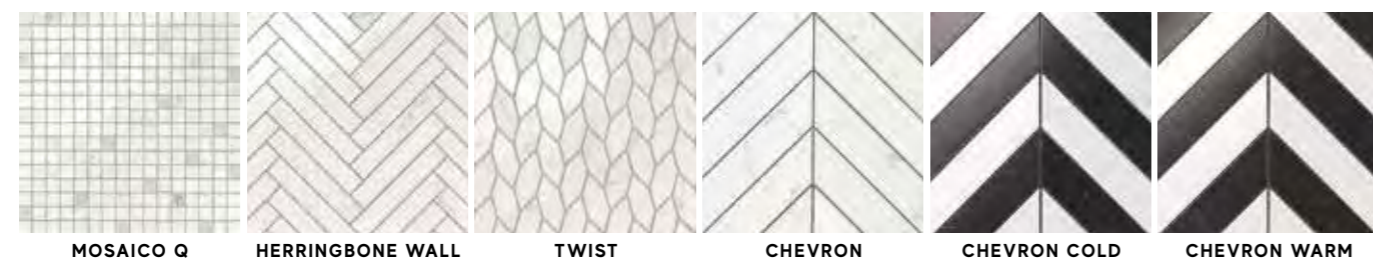

 LSSN Marvel Nero Marquina Spigolo
 0,8x20 cm - 3¹/₈"x7⁷/₈"

 AS1N Marvel Nero Marquina Spigolo A.E.
 0,8x0,8 cm - 3¹/₈"x3¹/₈"

DECORATIVE RANGE / GAMMA DECORATIVA

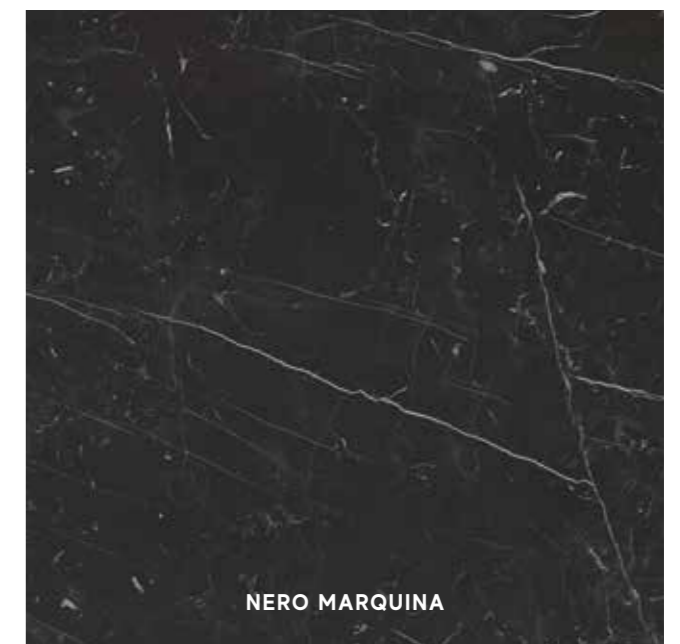
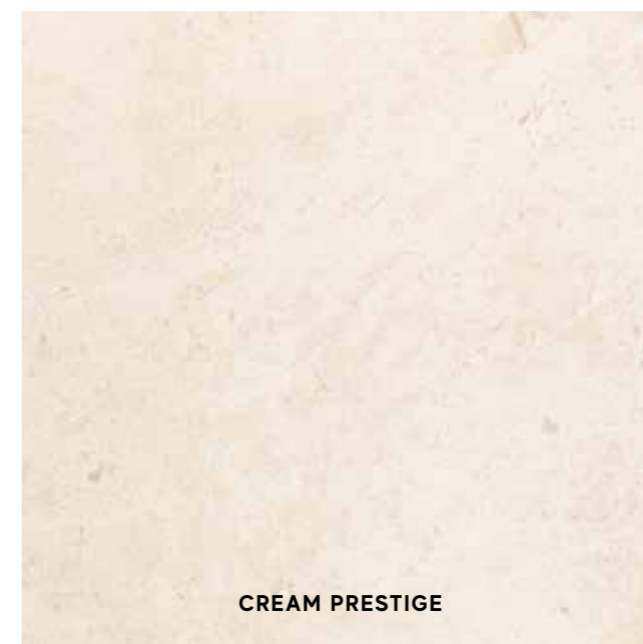

SHINY SURFACE | SUPERFICIE LUCIDA | Surface brillante | Glänzende oberfläche | Superficie brillante | Глянцевая поверхность



V2 SLIGHT VARIATION

Carrara Pure,
 Bardiglio Grey,
 Nero Marquina,
 Bianco Dolomite,
 Cream Prestige



AIX

PORCELAIN&WALL TILES



Porcelain Tiles / Gres Porcellanato

COLOURED BODY PORCELAIN TILES - RECTIFIED MONOCALIBER
GRES PORCELLANATO COLORATO IN MASSA - RETTIFICATO MONOCALIBRO

LARGE SIZES p. 366

Sizes	Thickness	Surface finish
120x120 cm - 47 ¹ / ₄ "x47 ¹ / ₄ "	± 9 mm	Matte R10 A+B
75x150 cm - 29 ¹ / ₂ "x59"	± 9 mm	Matte R10 A+B
75x75 cm - 29 ¹ / ₂ "x29 ¹ / ₂ "	± 9 mm	Matte R10 A+B
37,5x75 cm - 14 ³ / ₄ "x29 ¹ / ₂ "	± 9 mm	Matte R10 A+B

Outdoor Paving and Wet Areas

OUTDOOR PAVING p. 408

Sizes	Thickness	Surface finish
37,5x75 cm - 14 ³ / ₄ "x29 ¹ / ₂ "	± 9 mm	Grip R11 A+B+C
22,5x45,3 cm - 8 ⁷ / ₈ "x17 ³ / ₄ " > NON RECTIFIED - NON RETTIFICATO	± 9 mm	Textured R11 A+B+C
22,5x22,5 cm - 8 ⁷ / ₈ "x8 ⁷ / ₈ " > NON RECTIFIED - NON RETTIFICATO	± 9 mm	Textured R11 A+B+C
120x120 cm - 47 ¹ / ₄ "x47 ¹ / ₄ "	± 20 mm	Textured R11 A+B+C
60x90 cm - 23 ⁵ / ₈ "x35 ³ / ₈ "	± 20 mm	Textured R11 A+B+C
60x60 cm - 23 ⁵ / ₈ "x23 ⁵ / ₈ "	± 20 mm	Textured R11 A+B+C
22,5x45,4 cm - 8 ⁷ / ₈ "x17 ³ / ₄ " > NON RECTIFIED - NON RETTIFICATO	± 20 mm	Textured R11 A+B+C
22,5x22,5 cm - 8 ⁷ / ₈ "x8 ⁷ / ₈ " > NON RECTIFIED - NON RETTIFICATO	± 20 mm	Textured R11 A+B+C

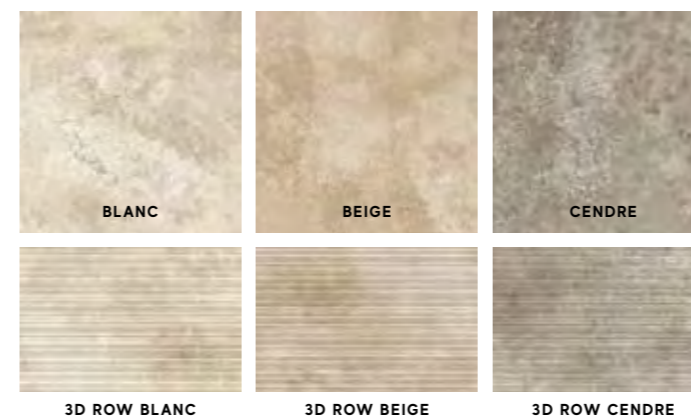

Wall Tiles / Rivestimento p. 442

WHITEBODY WALL TILES - RECTIFIED MONOCALIBER
RIVESTIMENTI IN PASTA BIANCA - RETTIFICATO MONOCALIBRO

Sizes	Thickness	Surface finish
40x80 cm - 15 ³ / ₄ "x31 ¹ / ₂ "	± 8,5 mm	Matte

3D Wall Tiles

Sizes	Thickness	Surface finish
40x80 cm - 15 ³ / ₄ "x31 ¹ / ₂ "	± 10 mm	Matte



Aix Porcelain Tiles / Gres Porcellanato

MATTE SURFACE / SUPERFICIE MATT

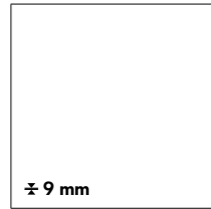

120x120 cm 47^{1/4}"x47^{1/4}"
A05N Aix Blanc 120x120
A05O Aix Beige 120x120
A05Q Aix Cendre 120x120
A05R Aix Fumée 120x120

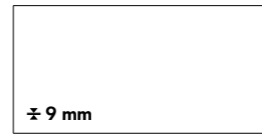

75x150 cm 29^{1/2}"x59"
APR8 Aix Blanc 75x150
APR9 Aix Beige 75x150
APSA Aix Cendre 75x150
APSB Aix Fumée 75x150

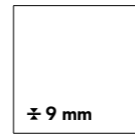

75x75 cm 29^{1/2}"x29^{1/2}"
APSC Aix Blanc 75x75
APSD Aix Beige 75x75
APSE Aix Cendre 75x75
APSF Aix Fumée 75x75

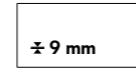

37,5x75 cm 14^{3/4}"x29^{1/2}"
APSG Aix Blanc 37,5x75
APSI Aix Beige 37,5x75
APSJ Aix Cendre 37,5x75
APSK Aix Fumée 37,5x75

MATTE / GRIP

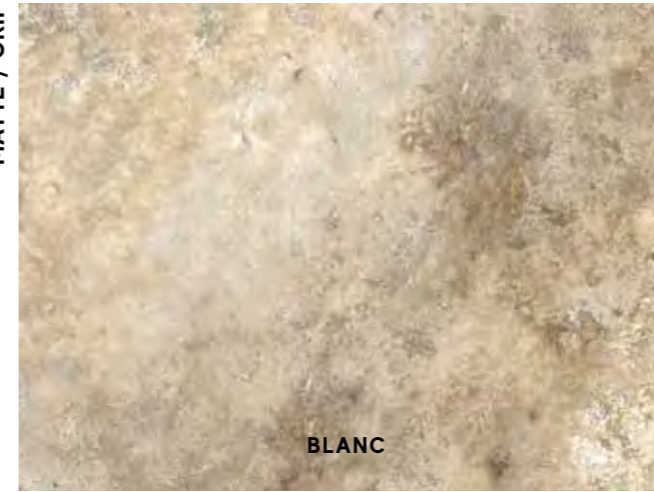

BLANC



BEIGE

STONE LOOK



GRIP SURFACE / SUPERFICIE GRIP

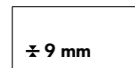

37,5x75 cm 14^{3/4}"x29^{1/2}"
APSL Aix Blanc 37,5x75 Grip
APSM Aix Beige 37,5x75 Grip
APSO Aix Cendre 37,5x75 Grip
APSQ Aix Fumée 37,5x75 Grip



CENDRE



FUMÉE



TEXTURED SURFACE / SUPERFICIE STRUTTURATA

NON RECTIFIED - NON RETTIFICATO

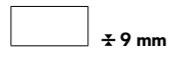

22,5x45,3 cm 8^{7/8}"x17^{3/8}"
APST Aix Beige 22,5x45,3 Strutturato
APSU Aix Cendre 22,5x45,3 Strutturato

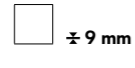

22,5x22,5 cm 8^{7/8}"x8^{7/8}"
APSR Aix Beige 22,5x22,5 Strutturato
APSS Aix Cendre 22,5x22,5 Strutturato

OUTDOOR PAVING ± 20 mm



BLANC



BEIGE



OUTDOOR PAVING ± 20 mm / PAVIMENTI DA ESTERNO ± 20 mm

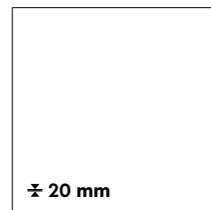

120x120 cm 47^{1/4}"x47^{1/4}"
A07C Aix Blanc 120x120 20 mm
A07E Aix Beige 120x120 20 mm
A07F Aix Cendre 120x120 20 mm
A07G Aix Fumée 120x120 20 mm



60x90 cm 23^{3/8}"x35^{3/8}"
AP1 Aix Blanc 60x90 20 mm
AP2 Aix Beige 60x90 20 mm
AP4 Aix Cendre 60x90 20 mm
AP5 Aix Fumée 60x90 20 mm

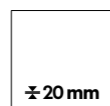

60x60 cm 23^{3/8}"x23^{3/8}"
APSZ Aix Beige 60x60 20 mm
APSØ Aix Cendre 60x60 20 mm

NON RECTIFIED

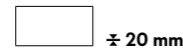

22,5x45,4 cm 8^{7/8}"x17^{3/8}"
APR2 Aix Beige 22,5x45,4 20 mm
APR3 Aix Cendre 22,5x45,4 20 mm

NON RECTIFIED

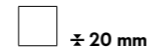

22,5x22,5 cm 8^{7/8}"x8^{7/8}"
APR4 Aix Beige 22,5x22,5 20 mm
APR5 Aix Cendre 22,5x22,5 20 mm



V3 MODERATE VARIATION
Blanc,
Beige,
Cendre,
Fumée



CENDRE



FUMÉE

STONE LOOK

MATTE SURFACE | SUPERFICIE MATT | Surface Mat | Matt oberfläche | Superficie Mate | Матовая поверхность
GRIP SURFACE | SUPERFICIE GRIP | Surface grip | Grip oberfläche | Superficie Grip | Грип поверхность
TEXTURED SURFACE | SUPERFICIE STRUTTURATA | Surface structuré | Strukturiert oberfläche | Superficie estructurado | Структурная поверхность
OUTDOOR PAVING | PAVIMENTI DA ESTERNO | Sols d'extérieur | Bodenbeläge für Außenbereiche | Pavimentos para exteriores | Уличная плитка

STONE LOOK

Aix Porcelain Tiles / Gres Porcellanato

DECOR RANGE / GAMMA DECORI



A04X Aix Blanc Kit Multifformato Tumbled *

- 1 pcs 75x75 - 29 1/2" x 29 1/2"
- 1 pcs 50x75 - 19 5/8" x 29 1/2"
- 1 pcs 50x50 - 19 5/8" x 19 5/8"
- 3 pcs 25x50 - 9 7/8" x 19 5/8"
- 2 pcs 25x25 - 9 7/8" x 9 7/8"



A04Y Aix Beige Kit Multifformato Tumbled *

- 1 pcs 75x75 - 29 1/2" x 29 1/2"
- 1 pcs 50x75 - 19 5/8" x 29 1/2"
- 1 pcs 50x50 - 19 5/8" x 19 5/8"
- 3 pcs 25x50 - 9 7/8" x 19 5/8"
- 2 pcs 25x25 - 9 7/8" x 9 7/8"



A04Z Aix Cendre Kit Multifformato Tumbled *

- 1 pcs 75x75 - 29 1/2" x 29 1/2"
- 1 pcs 50x75 - 19 5/8" x 29 1/2"
- 1 pcs 50x50 - 19 5/8" x 19 5/8"
- 3 pcs 25x50 - 9 7/8" x 19 5/8"
- 2 pcs 25x25 - 9 7/8" x 9 7/8"



A05C Aix Fumée Kit Multifformato Tumbled *

- 1 pcs 75x75 - 29 1/2" x 29 1/2"
- 1 pcs 50x75 - 19 5/8" x 29 1/2"
- 1 pcs 50x50 - 19 5/8" x 19 5/8"
- 3 pcs 25x50 - 9 7/8" x 19 5/8"
- 2 pcs 25x25 - 9 7/8" x 9 7/8"

The miniatures of the Kit Multifformato are not in proportion. / I minimali nel Kit Multifformato non sono in proporzione. / Les illustrations à échelle réduite dans le Kit Multifformato ne sont pas proportionnelles. | Die Abbildungen im Kit Multifformato sind nicht verhältnismäßig. / Los miniaturas en el Kit Multifformato no están en proporción. / Изображения Kit Multifformato не соблюдают пропорций.

Aix Porcelain Tiles / Gres Porcellanato

DECOR RANGE / GAMMA DECORI



A0UA Aix Blanc
Honeycomb Tumbled
30x31- 11³/₄"x12¹/₄"



A0UB Aix Beige
Honeycomb Tumbled
30x31- 11³/₄"x12¹/₄"



A0UC Aix Cendre
Honeycomb Tumbled
30x31- 11³/₄"x12¹/₄"



A0UD Aix Fumée
Honeycomb Tumbled
30x31- 11³/₄"x12¹/₄"

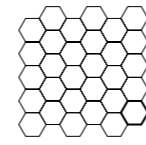

6,7x5,8 cm
2¹/₈"x2¹/₈"



A0TZ Aix Blanc
Mosaico Tumbled *
30x30 - 11³/₄"x11³/₄"



A0T0 Aix Beige
Mosaico Tumbled *
30x30 - 11³/₄"x11³/₄"



A0T8 Aix Cendre
Mosaico Tumbled *
30x30 - 11³/₄"x11³/₄"



A0T9 Aix Fumée
Mosaico Tumbled *
30x30 - 11³/₄"x11³/₄"

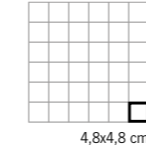

4,8x4,8 cm
1⁷/₈"x1⁷/₈"



A0UE Aix Blanc
Brick Tumbled *
37x37 - 14⁵/₈"x14⁵/₈"



A0UF Aix Beige
Brick Tumbled *
37x37 - 14⁵/₈"x14⁵/₈"



A0UG Aix Cendre
Mosaico Tumbled *
37x37 - 14⁵/₈"x14⁵/₈"



A0UH Aix Fumée
Mosaico Tumbled *
37x37 - 14⁵/₈"x14⁵/₈"

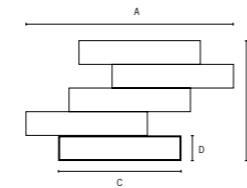

A 62,7 cm - 24³/₈"
B 36,7 cm - 14¹/₂"
C 36,65 cm - 14⁹/₈"
D 7,15 cm - 2⁷/₈"



atlas concorde

TRIM TILES / PEZZI SPECIALI

UPEC p. 571

	Battiscopa 7,2x75 - 2 ⁷ / ₈ "x29 ¹ / ₂ "	Gradino * 37,5x75 - 14 ³ / ₄ "x29 ¹ / ₂ "	Scalino * 37,5x150 - 14 ³ / ₄ "x59"	Scalino * 33x120 - 13"x47 ¹ / ₄ "	Scalino * 37,5x75 - 14 ³ / ₄ "x29 ¹ / ₂ "	Scalino Angolare * 37,5x37,5 - 14 ³ / ₄ "x14 ³ / ₄ "	Scalino Angolare * 33x33 - 13"x13"	Battiscopa Sag. Scala 7,2x30 - 2 ⁷ / ₈ "x11 ³ / ₄ "	Elemento L Grip * 15x75 H. 4 - 5 ⁷ / ₈ "x29 ¹ / ₂ "	Elemento L Strutturato * 15x30 H. 3,5 - 5 ⁷ / ₈ "x11 ³ / ₄ "	
	DX *	SX *									
Blanc	A0SF	A0SR	A0SV	A0ST	A0SZ	A0TJ	A0SY	A0SJ	A0SN	A0TR	-
Beige	A0SG	A0SS	A0SW	A0SU	A0S0	A0TK	A0SX	A0SK	A0SO	A0TS	A0TW
Cendre	A0SH	A0ST	A0SX	A0SV	A0S8	A0TP	A0SZ	A0SL	A0SP	A0TT	A0TX
Fumée	A0SI	A0SU	A0SY	A0SW	A0S9	A0TQ	A06J	A0SM	A0SQ	A0TU	-

* THESE PARTS ARE SUPPLIED TO ORDER | I PEZZI SONO DISPONIBILI SU ORDINAZIONE | Les pièces sont disponibles sur commande | Die Teile sind auf Bestellung lieferbar | Las piezas se hacen por encargo | Изготавливаются на заказ



Aix Wall Tiles / Rivestimento

MATTE SURFACE / SUPERFICIE MATT

± 8,5 mm

40x80 cm 15³/₄"x31¹/₂"
8AIB Aix Blanc 40x80
8AIE Aix Beige 40x80
8AIC Aix Cendre 40x80

3D WALL TILES / RIVESTIMENTO 3D

± 10 mm

40x80 cm 15³/₄"x31¹/₂"
8A3B Aix 3D Row Blanc 40x80
8A3E Aix 3D Row Beige 40x80
8A3C Aix 3D Row Cendre 40x80

TRIM TILES / PEZZI SPECIALI

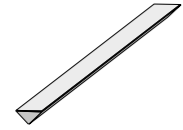

1,4x40 cm - 5⁵/₈"x15³/₄"
LAII Aix Blanc Corner 40 *
LAIE Aix Beige Corner 40 *
LAIC Aix Cendre Corner 40 *
LA3B Aix 3D Blanc Corner 40 *
LA3E Aix 3D Beige Corner 40 *
LA3C Aix 3D Cendre Corner 40 *



1,4x1,4 cm - 5⁵/₈"x5⁵/₈"
A0IB Aix Blanc Corner A.E. 1,4 *
A0IE Aix Beige Corner A.E. 1,4 *
A0IC Aix Cendre Corner A.E. 1,4 *

DECORATIVE RANGE / GAMMA DECORATIVA



MINIBRICK

* **THESE PARTS ARE SUPPLIED TO ORDER** . I PEZZI SONO DISPONIBILI SU ORDINAZIONE
Les pieces sont disponibles sur commande | Die Teile sind auf Bestellung lieferbar | Las piezas se hacen por encargo | Изготавливаются на заказ

WALL TILES p. 442



BLANC



3D ROW BLANC



BEIGE



3D ROW BEIGE



CENDRE



3D ROW CENDRE



V2 SLIGHT VARIATION

Blanc / 3D Row Blanc,
Beige / 3D Row Beige,
Cendre / 3D Row Cendre

atlas concorde

brave

PORCELAIN&WALL TILES



Porcelain Tiles / Gres Porcellanato

COLOURED BODY PORCELAIN TILES - RECTIFIED MONOCALIBER
GRES PORCELLANATO COLORATO IN MASSA - RETTIFICATO MONOCALIBRO

Sizes	Thickness	Surface finish
75x150 cm - 29 ¹ / ₂ "x59"	± 9 mm	Matte R10 A+B
75x75 cm - 29 ¹ / ₂ "x29 ¹ / ₂ "	± 9 mm	Matte R10 A+B
45x90 cm - 17 ³ / ₄ "x35 ³ / ₈ "	± 9 mm	Matte R10 A+B
60x60 cm - 23 ⁵ / ₈ "x23 ⁵ / ₈ "	± 9 mm	Matte R10 A+B
30x60 cm - 11 ³ / ₄ "x23 ⁵ / ₈ "	± 9 mm	Matte R10 A+B

Outdoor Paving and Wet Areas

OUTDOOR PAVING p. 408

Sizes	Thickness	Surface finish
30x60 cm - 11 ³ / ₄ "x23 ⁵ / ₈ "	± 9 mm	Grip R12 A+B+C
120x120 cm - 47 ¹ / ₄ "x47 ¹ / ₄ "	± 20 mm	Textured R11 A+B+C
60x120 cm - 23 ⁵ / ₈ "x47 ¹ / ₄ "	± 20 mm	Textured R11 A+B+C
60x60 cm - 23 ⁵ / ₈ "x23 ⁵ / ₈ "	± 20 mm	Textured R11 A+B+C
45x90 cm - 17 ³ / ₄ "x35 ³ / ₈ "	± 20 mm	Textured R11 A+B+C
30x60 cm - 11 ³ / ₄ "x23 ⁵ / ₈ "	± 20 mm	Textured R11 A+B+C



Wall Tiles / Rivestimento p. 470

WHITEBODY WALL TILES - RECTIFIED MONOCALIBER
RIVESTIMENTI IN PASTA BIANCA - RETTIFICATO MONOCALIBRO

Sizes	Thickness	Surface finish
40x80 cm - 15 ³ / ₄ "x31 ¹ / ₂ "	± 8,5 mm	Matte

3D Wall Tiles

Sizes	Thickness	Surface finish
40x80 cm - 15 ³ / ₄ "x31 ¹ / ₂ "	± 10 mm	Matte



Brave Porcelain Tiles / Gres Porcellanato

MATTE SURFACE / SUPERFICIE MATT



75x150 cm 29 1/2"x59"
AXAO Brave Gypsum 75x150
AXAP Brave Pearl 75x150
AXAQ Brave Grey 75x150
AXAR Brave Earth 75x150
AXAS Brave Coke 75x150

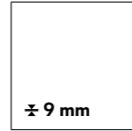

75x75 cm 29 1/2"x29 1/2"
AXAJ Brave Gypsum 75x75
AXAK Brave Pearl 75x75
AXAL Brave Grey 75x75
AXAM Brave Earth 75x75
AXAN Brave Coke 75x75

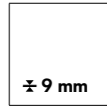

60x60 cm 23 3/8"x23 3/8"
AW9U Brave Gypsum 60x60
AW9V Brave Pearl 60x60
AW9W Brave Grey 60x60
AW9X Brave Earth 60x60
AW9Y Brave Coke 60x60

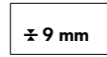

30x60 cm 11 3/4"x23 3/8"
D046 Brave Gypsum 30x60
D047 Brave Pearl 30x60
D048 Brave Grey 30x60
D049 Brave Earth 30x60
D050 Brave Coke 30x60

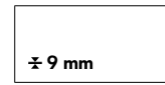

45x90 cm 17 3/4"x35 3/8"
AXAE Brave Gypsum 45x90
AXAF Brave Pearl 45x90
AXAG Brave Grey 45x90
AXAH Brave Earth 45x90
AXAI Brave Coke 45x90

GRIP SURFACE / SUPERFICIE GRIP

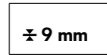

30x60 cm 11 3/4"x23 3/8"
D051 Brave Gypsum 30x60 Grip
D052 Brave Pearl 30x60 Grip
D053 Brave Grey 30x60 Grip
D054 Brave Earth 30x60 Grip
D055 Brave Coke 30x60 Grip

OUTDOOR PAVING ± 20 mm / PAVIMENTI DA ESTERNO ± 20 mm

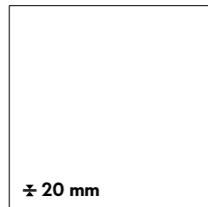

120x120 cm 47 1/8"x47 1/8"
AOX9 Brave Grey 120x120 LASTRA 20mm
AOYA Brave Coke 120x120 LASTRA 20mm

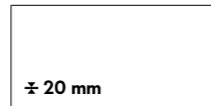

60x120 cm 23 3/8"x47 1/8"
AT5I Brave Gypsum 60x120 LASTRA 20mm
AT5J Brave Pearl 60x120 LASTRA 20mm
AT5K Brave Grey 60x120 LASTRA 20mm
AT5L Brave Earth 60x120 LASTRA 20mm
AT5M Brave Coke 60x120 LASTRA 20mm

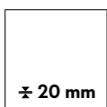

60x60 cm 23 3/8"x23 3/8"
AXAT Brave Gypsum 60x60 LASTRA 20mm
AXAU Brave Pearl 60x60 LASTRA 20mm
AXAV Brave Grey 60x60 LASTRA 20mm
AXAW Brave Earth 60x60 LASTRA 20mm
AXAX Brave Coke 60x60 LASTRA 20mm

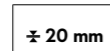

30x60 cm 11 3/4"x23 3/8"
ATZ1 Brave Gypsum 30x60 LASTRA 20mm
ATZ2 Brave Pearl 30x60 LASTRA 20mm
ATZ3 Brave Grey 30x60 LASTRA 20mm
ATZ4 Brave Earth 30x60 LASTRA 20mm
ATZ6 Brave Coke 30x60 LASTRA 20mm

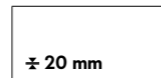

45x90 cm 17 3/4"x35 3/8"
AXAY Brave Gypsum 45x90 LASTRA 20mm
AXAZ Brave Pearl 45x90 LASTRA 20mm
AXBA Brave Grey 45x90 LASTRA 20mm
AXBB Brave Earth 45x90 LASTRA 20mm
AXBC Brave Coke 45x90 LASTRA 20mm

MATTE SURFACE | SUPERFICIE MATT | Surface Mat | Matt oberfläche | Superficie Mate | Матовая поверхность
GRIP SURFACE | SUPERFICIE GRIP | Surface grip | Grip oberfläche | Superficie Grip | Grip поверхность
OUTDOOR PAVING | PAVIMENTI DA ESTERNO | Sols d'extérieur | Bodenbeläge für Außenbereiche | Pavimentos para exteriores | Уличная плитка

MATTE / GRIP



GYPSUM



PEARL

OUTDOOR PAVING ± 20 mm



GYPSUM



PEARL



EARTH



GREY



EARTH



GREY



COKE



COKE



V2 SLIGHT VARIATION

Gypsum,
Pearl,
Earth,
Grey,
Coke

Brave Porcelain Tiles / Gres Porcellanato

DECOR RANGE / GAMMA DECORI

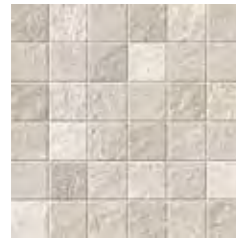

A1FM Brave Gypsum Mosaico
30x30 - 11³/₄"x11³/₄"

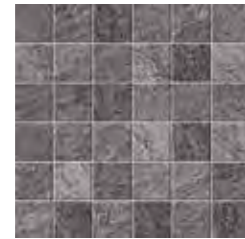

A1FO Brave Grey Mosaico
30x30 - 11³/₄"x11³/₄"



A1FQ Brave Coke Mosaico
30x30 - 11³/₄"x11³/₄"



A1FN Brave Pearl Mosaico
30x30 - 11³/₄"x11³/₄"

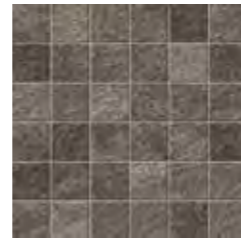

A1FP Brave Earth Mosaico
30x30 - 11³/₄"x11³/₄"

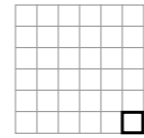

4,8x4,8 cm
1⁷/₈"x1⁷/₈"



A1FW Brave Gypsum Industrial 3D *
44x28,5 - 17³/₈"x11¹/₄"



A1FY Brave Grey Industrial 3D *
44x28,5 - 17³/₈"x11¹/₄"

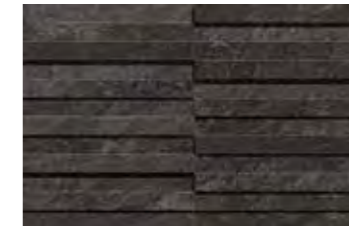

A1FØ Brave Coke Industrial 3D *
44x28,5 - 17³/₈"x11¹/₄"

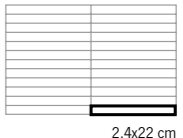

2,4x22 cm
1"x8⁵/₈"



A1FX Brave Pearl Industrial 3D *
44x28,5 - 17³/₈"x11¹/₄"

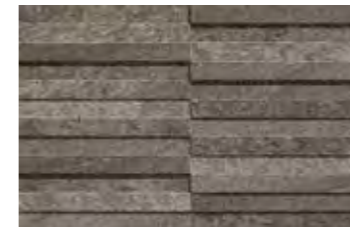

A1FZ Brave Earth Industrial 3D *
44x28,5 - 17³/₈"x11¹/₄"

* **MULTI-THICKNESS MOSAIC, CLOSE JOINT INSTALLATION WITHOUT GROUTING.**
MOSAICO MULTISPESORE, POSA SENZA STUCCATURA A GIUNTO UNITO.
Mosaïque multi-épaisseur, pose sans mastic avec joint nul.
Mosaik mit verschiedenen Stärken, fugenlose Verlegung ohne Mörtel.
Mosaico multiespesor, colocación sin mástique y sin juntas.
Мозаика разной толщины; укладка встык без затирки швов.



A1F1 Brave Gypsum Brick 3D *
29x59 - 11³/₈"x23¹/₄"



A1F2 Brave Pearl Brick 3D *
29x59 - 11³/₈"x23¹/₄"



A1F3 Brave Grey Brick 3D *
29x59 - 11³/₈"x23¹/₄"



A1F4 Brave Earth Brick 3D *
29x59 - 11³/₈"x23¹/₄"



A1F5 Brave Coke Brick 3D *
29x59 - 11³/₈"x23¹/₄"

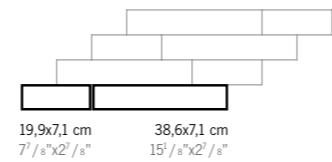

19,9x7,1 cm
7⁷/₈"x2⁷/₈"
38,6x7,1 cm
15¹/₈"x2⁷/₈"



A1X5 Brave Gypsum Listello 8x60
8x60 - 3¹/₈"x23⁵/₈"



A1X4 Brave Grey Listello 8x60
8x60 - 3¹/₈"x23⁵/₈"



A1X2 Brave Coke Listello 8x60
8x60 - 3¹/₈"x23⁵/₈"



A1X6 Brave Pearl Listello 8x60
8x60 - 3¹/₈"x23⁵/₈"



A1X3 Brave Earth Listello 8x60
8x60 - 3¹/₈"x23⁵/₈"



TRIM TILES / PEZZI SPECIALI

p. 424

LUPEC p. 571

	Battiscopa 7,2x60 2 ⁷ / ₈ "x23 ⁵ / ₈ "	Gradino * 30x60 11 ³ / ₄ "x23 ⁵ / ₈ "	Scalino * 33x150 13"x59"	Scalino *			Scalino Angolare 33x33 - 13"x13"		Battiscopa Sag. Scala 7,2x30 - 2 ⁷ / ₈ "x11 ³ / ₄ "		Elemento L Grip * 15x60 H. 4 5 ⁷ / ₈ "x23 ⁵ / ₈ "
				Scalino * 33x90 13"x35 ⁵ / ₈ "	Scalino * 33x75 13"x29 ¹ / ₂ "	Scalino * 33x60 13"x23 ⁵ / ₈ "	DX * SX *	DX * SX *			
Gypsum	A1IE	A1IJ	AZT9	A1IP	A1IU	A1IZ	A1JA	A1I4	A1JK	A1JF	A1JP
Pearl	A1IF	A1IL	AZUA	A1IQ	A1IV	A1IØ	A1JB	A1I5	A1JL	A1JG	A1JQ
Grey	A1IG	A1IM	A1ZQ	A1IR	A1IW	A1I1	A1JC	A1I6	A1JM	A1JH	A1JR
Earth	A1IH	A1IN	AZUB	A1IS	A1IX	A1I2	A1JD	A1I7	A1JN	A1JI	A1JS
Coke	A1II	A1IO	AZEW	A1IT	A1IY	A1I3	A1JE	A1I8	A1JO	A1JJ	A1JT

* THESE PARTS ARE SUPPLIED TO ORDER | I PEZZI SONO DISPONIBILI SU ORDINAZIONE | Les pièces sont disponibles sur commande | Die Teile sind auf Bestellung lieferbar | Las piezas se hacen por encargo | Изготавливаются на заказ

THE DECORATION CAN ONLY BE LAID ON THE WALL | IL DECORO SI PUÒ POSARE SOLO A RIVESTIMENTO
Décor uniquement mural | Das Dekor kann nur an der Wand verlegt werden | La decoración se puede colocar únicamente en paredes | Декор может быть уложен только на стену.

STONE LOOK

STONE LOOK



Brave Wall Tiles / Rivestimento

MATTE SURFACE / SUPERFICIE MATT



40x80 cm 15³/₄"x31¹/₂"
8BWU Brave Gypsum 40x80
8BWL Brave Pearl 40x80
8BWY Brave Grey 40x80

TRIM TILES / PEZZI SPECIALI

LBSU Brave Gypsum Spigolo 0,8
0,8x20 cm - 3¹/₈"x7⁷/₈"

A1BU Brave Gypsum Spigolo 0,8 A.E.
0,8x0,8 cm - 3¹/₈"x3¹/₈"

LBSL Brave Pearl Spigolo 0,8
0,8x20 cm - 3¹/₈"x7⁷/₈"

A1BL Brave Pearl Spigolo 0,8 A.E.
0,8x0,8 cm - 3¹/₈"x3¹/₈"

LBSE Brave Grey Spigolo 0,8
0,8x20 cm - 3¹/₈"x7⁷/₈"

A1BR Brave Grey Spigolo 0,8 A.E.
0,8x0,8 cm - 3¹/₈"x3¹/₈"

DECORATIVE RANGE / GAMMA DECORATIVA



MOSAIC

* THESE PARTS ARE SUPPLIED TO ORDER . I PEZZI SONO DISPONIBILI SU ORDINAZIONE
Les pièces sont disponibles sur commande | Die Teile sind auf Bestellung lieferbar | Las piezas se hacen por encargo | Изготавливаются на заказ



atlas concorde

The 10 mm edge matches three-dimensional wall tiles having a 10-11 mm thickness / Lo spigolo 10 mm si abbinna a rivestimenti tridimensionali di spessore 10-11 mm. / Le bord 10 mm s'adapte aux revêtements tridimensionnels épaisseur 10-11 mm. / Die 10 mm Kante ist mit dreidimensionalen Wandfliesen mit einer Dicke von 10-11 mm kombinierbar. / La arista de 10 mm se combina con revestimientos tridimensionales de 10 -11 mm de grosor. / Угловой элемент 10 мм сочетается с трехмерной настенной плиткой толщиной 10-11 мм.

MATTE SURFACE | SUPERFICIE MATT | Surface Mat | Matt oberfläche | Superficie Mate | Матовая поверхность

WALL TILES p. 470

3D WALL TILES / RIVESTIMENTO 3D



40x80 cm 15³/₄"x31¹/₂"
8BDG Brave 3D Wave Gypsum 40x80
8BBG Brave 3D Blade Gypsum 40x80
8BDP Brave 3D Wave Pearl 40x80
8BDE Brave 3D Wave Grey 40x80

LB1G Brave Gypsum Spigolo 10mm *
1x20 cm - 3¹/₈"x7⁷/₈"

LB1R Brave Pearl Spigolo 10mm *
1x20 cm - 3¹/₈"x7⁷/₈"

LB1E Brave Grey Spigolo 10mm *
1x20 cm - 3¹/₈"x7⁷/₈"

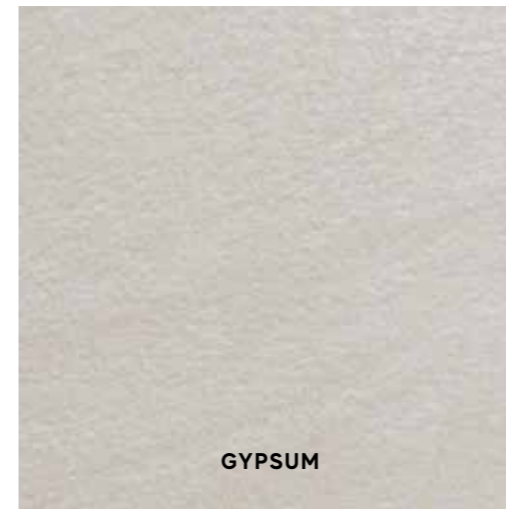

GYPSUM



3D WAVE GYPSUM

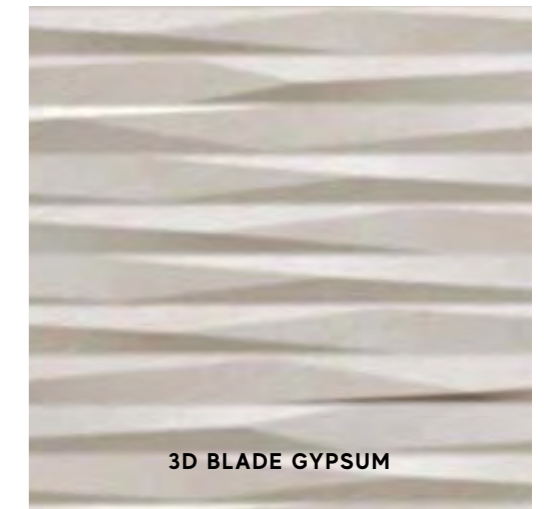

3D BLADE GYPSUM



PEARL



3D WAVE PEARL



GREY



3D WAVE GREY



V2 SLIGHT VARIATION

Gypsum,
Pearl,
Grey,
3D Wave Gypsum,
3D Blade Gypsum,
3D Wave Pearl,
3D Wave Grey

STONE LOOK

249



atlas concorde

DOLMEN PRO

PORCELAIN TILES

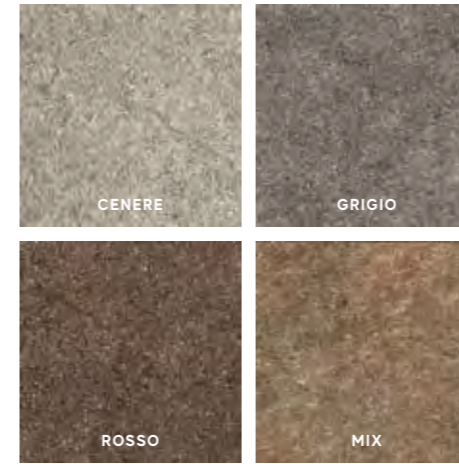

Porcelain Tiles / Gres Porcellanato

COLOURED BODY PORCELAIN TILES - RECTIFIED MONOCALIBER
GRES PORCELLANATO COLORATO IN MASSA - RETTIFICATO MONOCALIBRO

LARGE SIZES p. 366

Sizes	Thickness	Surface finish
162x324 cm - 63 ³ / ₄ "x127 ¹ / ₂ " > NON RECTIFIED - NON RETTIFICATO	± 6, 12, 20 mm	Matte
75x150 cm - 29 ¹ / ₂ "x59"	± 9 mm	Matte R10 A+B
75x75 cm - 29 ¹ / ₂ "x29 ¹ / ₂ "	± 9 mm	Matte R10 A+B
37,5x75 cm - 14 ³ / ₄ "x29 ¹ / ₂ "	± 9 mm	Matte R10 A+B

Outdoor Paving and Wet Areas

OUTDOOR PAVING p. 408

Sizes	Thickness	Surface finish
37,5x75 cm - 14 ³ / ₄ "x29 ¹ / ₂ "	± 9 mm	Grip R11 A+B+C
22,5x45,3 cm - 8 ⁷ / ₈ "x17 ³ / ₄ " > NON RECTIFIED - NON RETTIFICATO	± 9 mm	Textured R11 A+B+C
22,5x22,5 cm - 8 ⁷ / ₈ "x8 ⁷ / ₈ " > NON RECTIFIED - NON RETTIFICATO	± 9 mm	Textured R11 A+B+C
60x120 cm - 23 ⁵ / ₈ "x47 ¹ / ₄ "	± 20 mm	Textured R11 A+B+C
22,5x45,4 cm - 8 ⁷ / ₈ "x17 ³ / ₄ " > NON RECTIFIED - NON RETTIFICATO	± 20 mm	Textured R11 A+B+C
22,5x22,5 cm - 8 ⁷ / ₈ "x8 ⁷ / ₈ " > NON RECTIFIED - NON RETTIFICATO	± 20 mm	Textured R11 A+B+C



COLOURED BODY PORCELAIN TILES | GRES PORCELLANATO COLORATO IN MASSA | Grès cérame coloré dans la masse | Durchgefärbtes Feinsteinzeug | Gres porcelánico coloreado en masa | Керамический гранит окрашенный в массе
RECTIFIED MONOCALIBER | RETTIFICATO MONOCALIBRO | Rectifié mono-calibre | Geschliffen einkalibrig | Rettificato monocalibre | Ретифицированный в одном калибре
NON RECTIFIED | NON RETTIFICATO | Non rectifié | Nicht rektifiziert | No rectificada | Неретифицированные



Dolmen Pro Porcelain Tiles / Gres Porcellanato

MATTE SURFACE / SUPERFICIE MATT



75x150 cm 29 1/2"x59"
APCX Dolmen Pro Cenere 75x150
APCZ Dolmen Pro Grigio 75x150
APCY Dolmen Pro Rosso 75x150

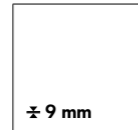

75x75 cm 29 1/2"x29 1/2"
APP0 Dolmen Pro Cenere 75x75
APP1 Dolmen Pro Grigio 75x75
APP3 Dolmen Pro Rosso 75x75



37,5x75 cm 14 3/4"x29 1/2"
APP4 Dolmen Pro Cenere 37,5x75
APP5 Dolmen Pro Grigio 37,5x75
APP6 Dolmen Pro Rosso 37,5x75
APP7 Dolmen Pro Mix 37,5x75

atlas-PLAN p. 366



MATTE / MATT
162x324 cm 63 3/4"x127 1/2"
> **NON RECTIFIED / NON RETTIFICATO**
A2X7 Dolmen Pro Grigio Matt ± 6 mm
A2YD Dolmen Pro Grigio Matt ± 6 mm ST *
A0X9 Dolmen Pro Grigio Matt ± 12 mm
A0X8 Dolmen Pro Grigio Matt ± 12 mm ST *
A2XP Dolmen Pro Grigio Matt ± 20 mm

GRIP SURFACE / SUPERFICIE GRIP

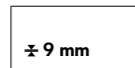

37,5x75 cm 14 3/4"x29 1/2"
APP8 Dolmen Pro Cenere 37,5x75 Grip
APP9 Dolmen Pro Grigio 37,5x75 Grip
APQA Dolmen Pro Rosso 37,5x75 Grip
APQB Dolmen Pro Mix 37,5x75 Grip

TEXTURED SURFACE / SUPERFICIE STRUTTURATA

NON RECTIFIED - NON RETTIFICATO

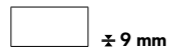

22,5x45,3 cm 8 7/8"x17 3/4"
APQG Dolmen Pro Cenere 22,5x45,3 Strutturato
APQH Dolmen Pro Grigio 22,5x45,3 Strutturato
APQI Dolmen Pro Rosso 22,5x45,3 Strutturato
APQJ Dolmen Pro Mix 22,5x45,3 Strutturato

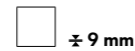

22,5x22,5 cm 8 7/8"x8 7/8"
APQC Dolmen Pro Cenere 22,5x22,5 Strutturato
APQD Dolmen Pro Grigio 22,5x22,5 Strutturato
APQE Dolmen Pro Rosso 22,5x22,5 Strutturato
APQF Dolmen Pro Mix 22,5x22,5 Strutturato

OUTDOOR PAVING ± 20 mm / PAVIMENTI DA ESTERNO ± 20 mm



60x120 cm 23 5/8"x47 1/4"
APQP Dolmen Pro Cenere 60x120 20 mm
APQQ Dolmen Pro Grigio 60x120 20 mm
APQS Dolmen Pro Rosso 60x120 20 mm

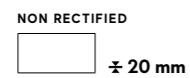

22,5x45,4 cm 8 7/8"x17 3/4"
APQK Dolmen Pro Rosso 22,5x45,4 20 mm
APQL Dolmen Pro Mix 22,5x45,4 20 mm

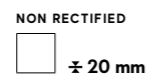

22,5x22,5 cm 8 7/8"x8 7/8"
APQN Dolmen Pro Rosso 22,5x22,5 20 mm
APQO Dolmen Pro Mix 22,5x22,5 20 mm

MATTE SURFACE | SUPERFICIE MATT | Surface Mat | Matt oberfläche | Superficie Mate | Матовая поверхность
TEXTURED SURFACE | SUPERFICIE STRUTTURATA | Surface structurée | Strukturiert oberfläche | Superficie estructurado | Структурная поверхность
GRIP SURFACE | SUPERFICIE GRIP | Surface grip | Grip oberfläche | Superficie Grip | Grip поверхность
OUTDOOR PAVING | PAVIMENTI DA ESTERNO | Sols d'extérieur | Bodenbeläge für Außenbereiche | Pavimentos para exteriores | Уличная плитка
* WITH FIBERGLASS MESH | VERSIONE STUOIATA | Version à nattes | Ausführung mit Glasfasermatte | Versión con malla | С упрочнением из стекловолокон
NON RECTIFIED | NON RETTIFICATO | Non rectifié | Nicht rektifiziert | No rectificada | Неретифицированные

MATTE / GRIP

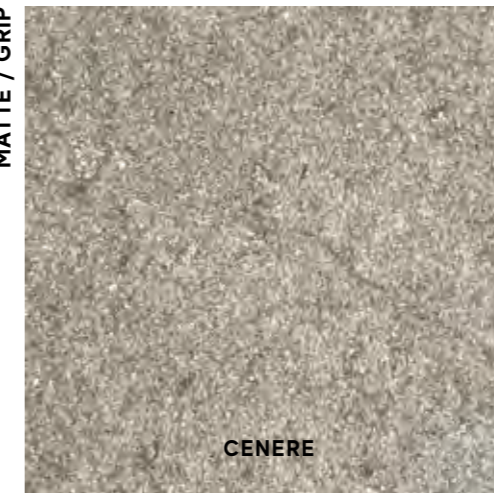

CENERE



GRIGIO



ROSSO

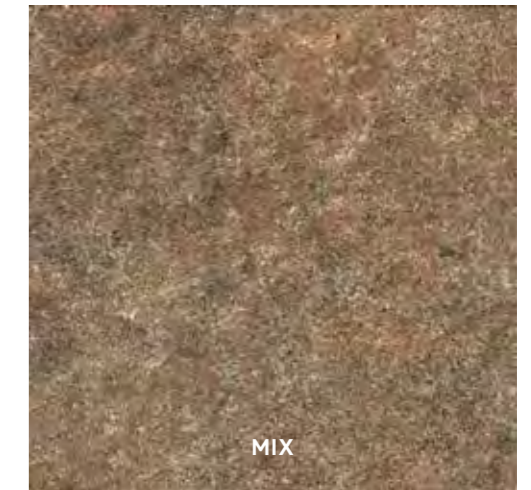

MIX

TEXTURED / OUTDOOR PAVING ± 20 mm

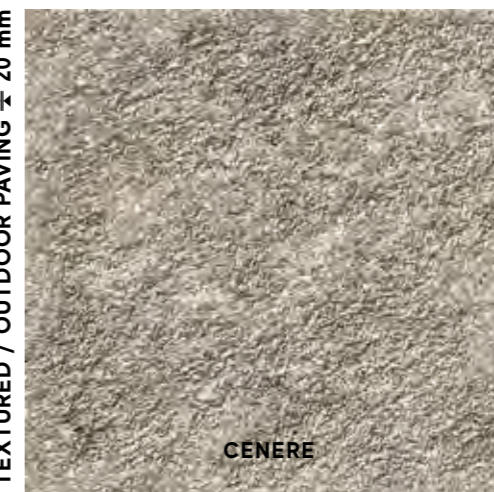

CENERE



GRIGIO



ROSSO



MIX



V2 SLIGHT VARIATION
Cenere, Grigio, Rosso



V4 SUBSTANTIAL VARIATION
Mix

Dolmen Pro Porcelain Tiles / Gres Porcellanato

DECOR RANGE / GAMMA DECORI

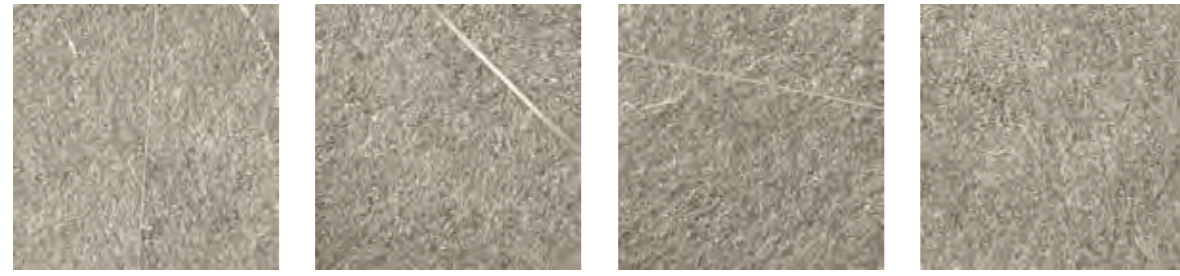

A02X Dolmen Pro Cenere
Squares Mix 4 *
34x34 - 13³/₈"x13³/₈"



A02Y Dolmen Pro Grigio
Squares Mix 4 *
34x34 - 13³/₈"x13³/₈"



A02Z Dolmen Pro Rosso
Squares Mix 4 *
34x34 - 13³/₈"x13³/₈"

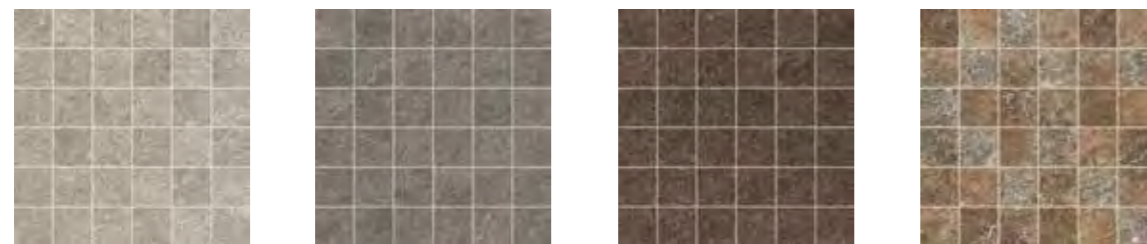

A02H Dolmen Pro
Cenere Mosaico
30x30 - 11³/₄"x11³/₄"

A02I Dolmen Pro
Grigio Mosaico
30x30 - 11³/₄"x11³/₄"

A02K Dolmen Pro
Rosso Mosaico
30x30 - 11³/₄"x11³/₄"

A02L Dolmen Pro
Mix Mosaico
30x30 - 11³/₄"x11³/₄"

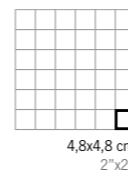
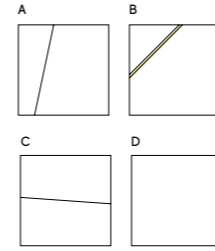

A02M Dolmen Pro
Cenere Brick
37,5x75 - 14³/₄"x29¹/₂"



A02N Dolmen Pro
Grigio Brick
37,5x75 - 14³/₄"x29¹/₂"



A02O Dolmen Pro
Rosso Brick
37,5x75 - 14³/₄"x29¹/₂"



A02Q Dolmen Pro
Mix Brick
37,5x75 - 14³/₄"x29¹/₂"

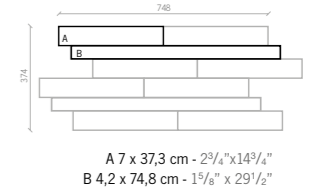

* Metal insert. We recommend use of a neutral detergent. Do not use acid, alkaline or waxing products or metal scouring pads. / Insetto metallico. Si consiglia l'utilizzo di un comune detergente neutro, evitare l'utilizzo di prodotti acidi o alcalini, ceranti e pagliette di metallo. / Inset métallique. Il est conseillé d'utiliser un produit détergent commun et neutre, d'éviter d'utiliser des produits acides ou alcalins, à base de cire ainsi que les pailles de métal. / Metalleinlage. Ein handelsübliches, neutrales Reinigungsmittel und keine sauren oder alkalischen, wachshaltigen Produkte oder Stahlwolle verwenden. / Inseto metálico. Se recomienda utilizar un detergente neutro y evitar productos ácidos o alcalinos, ceras y estropajos metálicos. / Металлическая вставка. Рекомендуется использовать обычное нейтральное моющее средство, избегать использования кислотных или щелочных продуктов, а также средств для вождения и металлических мочалок.

THE DECORATION CAN ONLY BE LAID ON THE WALL | IL DECORO SI PUÒ POSARE SOLO A RIVESTIMENTO
Décor uniquement mural | Das Dekor kann nur an der Wand verlegt werden | La decoración se puede colocar únicamente en paredes | Декор может быть уложен только на стену.

Dolmen Pro Porcelain Tiles / Gres Porcellanato

DECOR RANGE / GAMMA DECORI

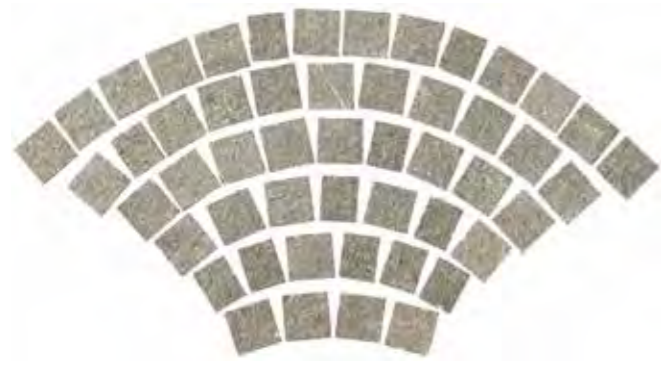

A02R Dolmen Pro Cenere
Coda di Pavone Grip
53,2x102,8 - 20⁷/₈"x40¹/₂"



A02T Dolmen Pro Grigio
Coda di Pavone Grip
53,2x102,8 - 20⁷/₈"x40¹/₂"



A02U Dolmen Pro Rosso
Coda di Pavone Grip
53,2x102,8 - 20⁷/₈"x40¹/₂"

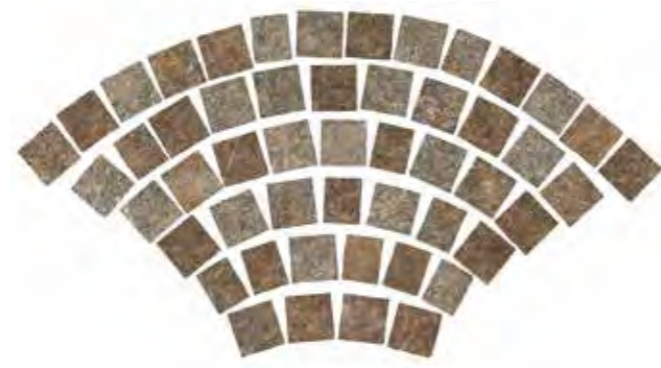

A02V Dolmen Pro Mix
Coda di Pavone Grip
53,2x102,8 - 20⁷/₈"x40¹/₂"

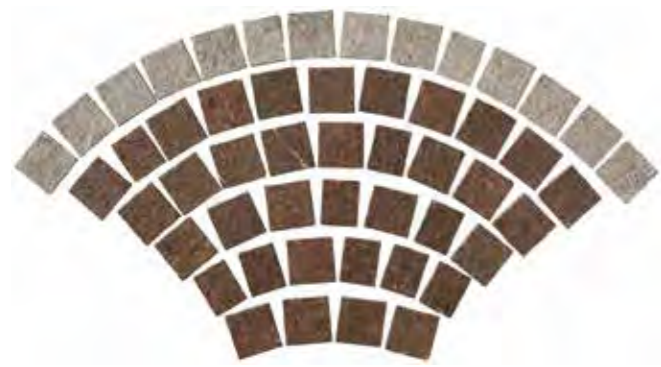

A02W Dolmen Pro Cenere-Rosso
Coda di Pav. Grip
53,2x102,8 - 20⁷/₈"x40¹/₂"

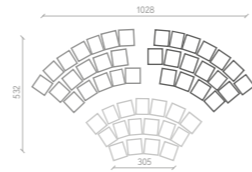

TRIM TILES / PEZZI SPECIALI

p. 424

UPEC p. 571

	Battiscopa 7,2x75 - 2 ⁷ / ₈ "x29 ¹ / ₂ "	Gradino* 37,5x75 - 14 ³ / ₄ "x29 ¹ / ₂ "	Scalino* 37,5x150 - 14 ³ / ₄ "x59"	Scalino* 37,5x75 - 14 ³ / ₄ "x29 ¹ / ₂ "	Scalino Angolare* 37,5x37,5 - 14 ³ / ₄ "x14 ³ / ₄ "	Battiscopa Sag. Scala 7,2x30 - 2 ⁷ / ₈ "x11 ¹ / ₄ "		Elemento L Grip* 15x75 H. 4 - 5 ⁷ / ₈ "x29 ¹ / ₂ "	Elemento L Strutturato* 15x30 H. 3,5 - 5 ⁷ / ₈ "x11 ¹ / ₄ "
						DX*	SX*		
Cenere	A0U1	A0VE	A0VI	A0VL	A0VP	A0U5	A0U9	A0VT	A04P
Grigio	A0U2	A0VF	A0VJ	A0VM	A0VQ	A0U6	A0VB	A0VU	A04Q
Rosso	A0U3	A0VG	A0VK	A0VN	A0VR	A0U7	A0VC	A0VV	A0TV
Mix	A0U4	A0VH	-	A0VO	A0VS	A0U8	A0VD	A0VW	A0TY

* THESE PARTS ARE SUPPLIED TO ORDER | I PEZZI SONO DISPONIBILI SU ORDINAZIONE | Les pièces sont disponibles sur commande | Die Teile sind auf Bestellung lieferbar | Las piezas se hacen por encargo | Изготавливаются на заказ



STONE LOOK

STONE LOOK



atlas concorde

ECHO

OUTDOOR PAVING

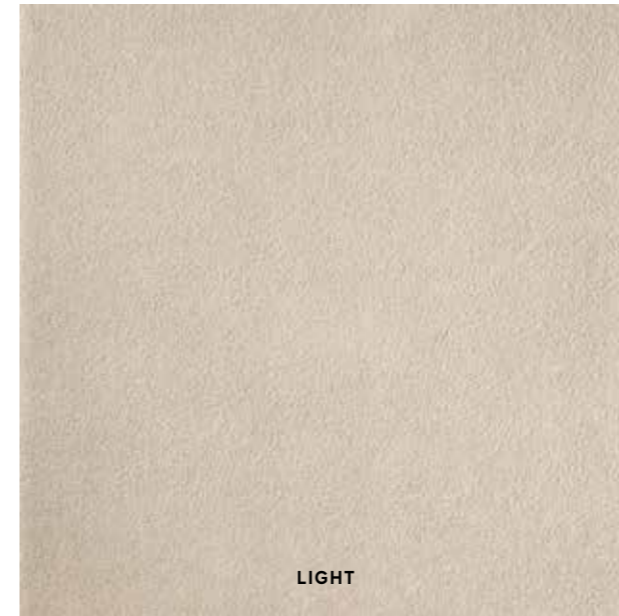

LIGHT

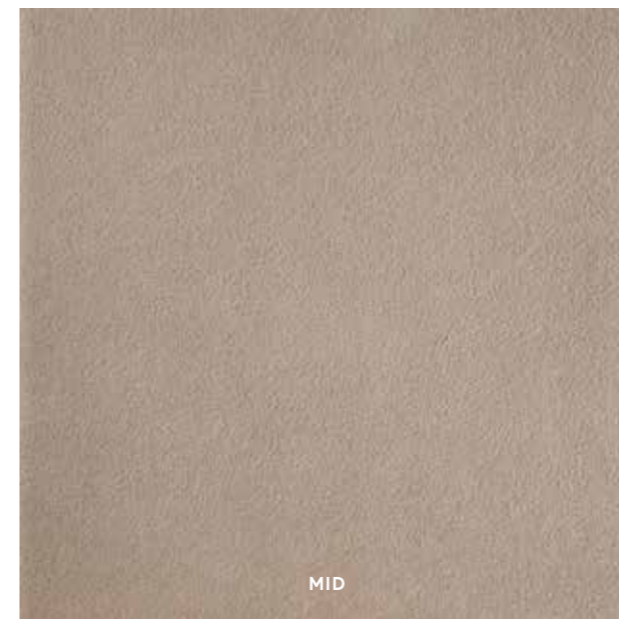

MID

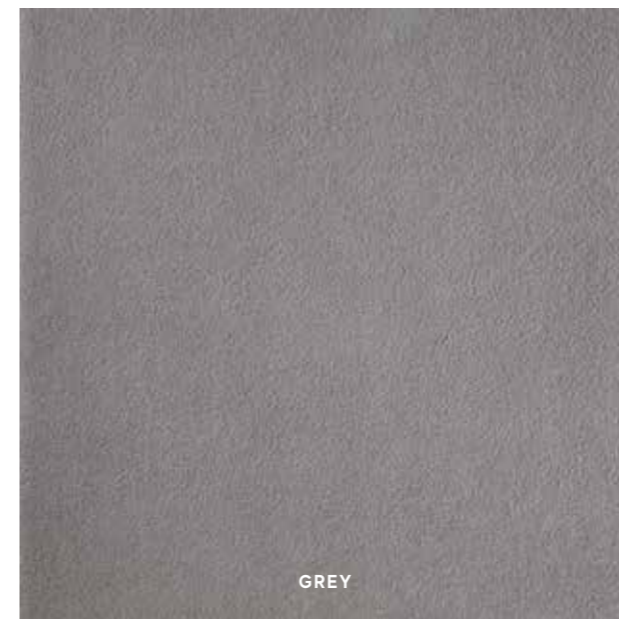

GREY

Porcelain Tiles / Gres Porcellanato

COLOURED BODY PORCELAIN TILES - RECTIFIED MONOCALIBER
GRES PORCELLANATO COLORATO IN MASSA - RETTIFICATO MONOCALIBRO

OUTDOOR PAVING ± 20 mm /
PAVIMENTI DA ESTERNO ± 20 mm

OUTDOOR PAVING p. 408

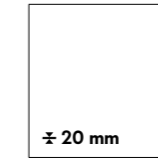

90x90 cm 35³/₈"x35³/₈"
AON8 Echo Light 90x90 Lastra 20mm
AON9 Echo Mid 90x90 Lastra 20mm
ANYH Echo Grey 90x90 Lastra 20mm



V2 SLIGHT VARIATION
Light,
Mid,
Grey

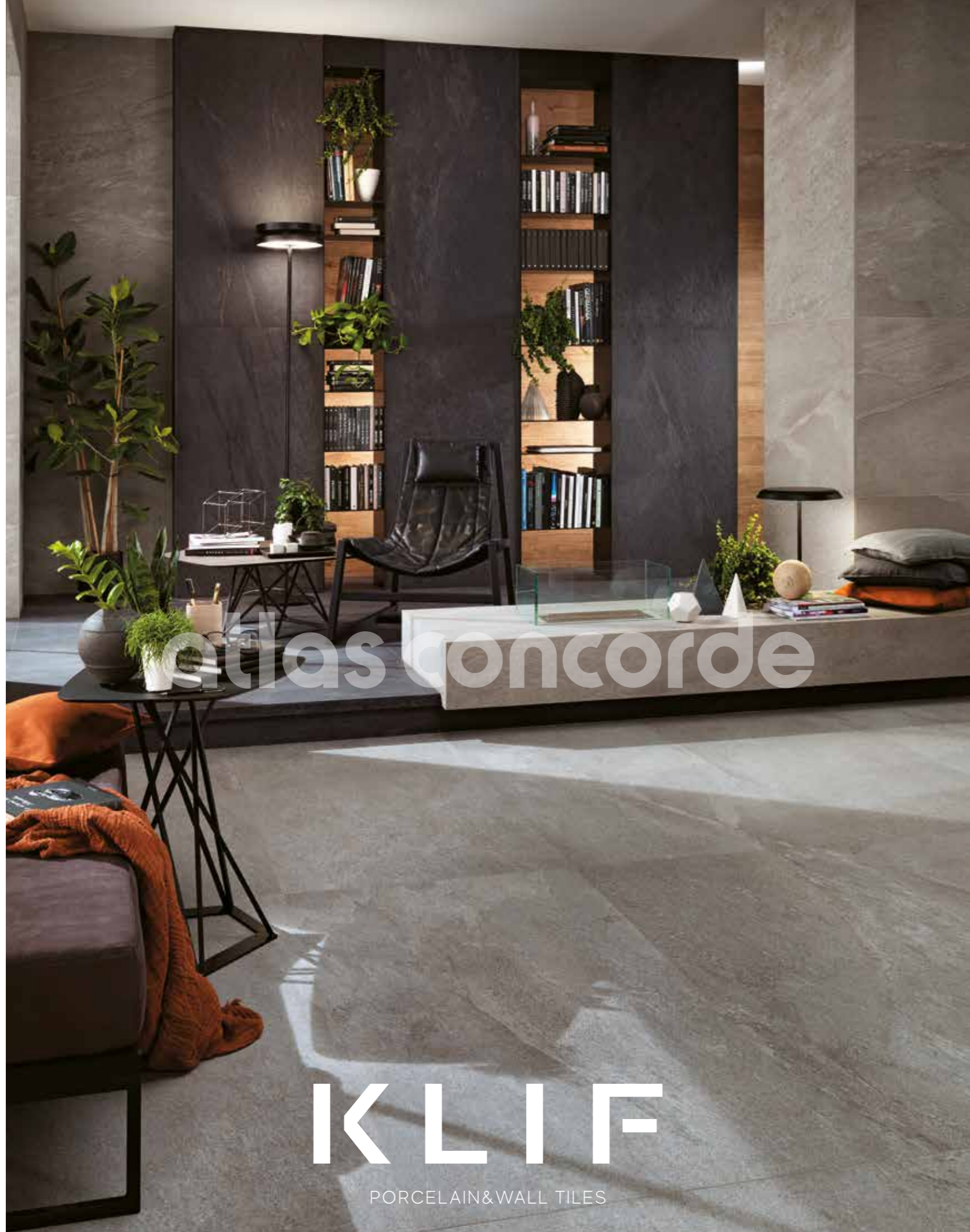

KLIF
PORCELAIN&WALL TILES

Porcelain tiles / Gres porcellanato

COLOURED BODY PORCELAIN TILES - RECTIFIED MONOCALIBER
GRES PORCELLANATO COLORATO IN MASSA - RETTIFICATO MONOCALIBRO



Sizes	Thickness	Surface finish
75x150 cm - 29 ¹ / ₂ "x59"	± 9 mm	Matte R10 A+B
75x75 cm - 29 ¹ / ₂ "x29 ¹ / ₂ "	± 9 mm	Matte R10 A+B
37,5x75 cm - 14 ³ / ₄ "x29 ¹ / ₂ "	± 9 mm	Matte R10 A+B

Outdoor Paving and Wet Areas

OUTDOOR PAVING p. 408

Sizes	Thickness	Surface finish
37,5x75 cm - 14 ³ / ₄ "x29 ¹ / ₂ "	± 9 mm	Grip R11 A+B+C
90x90 cm - 35 ³ / ₈ "x35 ³ / ₈ "	± 20 mm	Textured R11 A+B+C
45x90 cm - 17 ³ / ₄ "x35 ³ / ₈ "	± 20 mm	Textured R11 A+B+C
60x60 cm - 23 ⁵ / ₈ "x23 ⁵ / ₈ "	± 20 mm	Textured R11 A+B+C



Wall tiles / Rivestimento p. 486

WHITEBODY WALL TILES - RECTIFIED MONOCALIBER
RIVESTIMENTI IN PASTA BIANCA - RETTIFICATO MONOCALIBRO

Sizes	Thickness	Surface finish
40x80 cm - 15 ³ / ₄ "x31 ¹ / ₂ "	± 8,5 mm	Matte

3D Wall Tiles

Sizes	Thickness	Surface finish
40x80 cm - 15 ³ / ₄ "x31 ¹ / ₂ "	± 10 mm	Matte



Klif Porcelain Tiles / Gres Porcellanato

MATTE SURFACE / SUPERFICIE MATT



75x150 cm 29 1/2" x 59"
ANXM Klif White 75x150
ANXP Klif Silver 75x150
ANXQ Klif Grey 75x150
ANXR Klif Dark 75x150

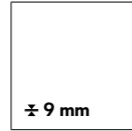

75x75 cm 29 1/2" x 29 1/2"
ANXS Klif White 75x75
ANXT Klif Silver 75x75
ANXU Klif Grey 75x75
ANXV Klif Dark 75x75

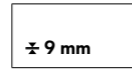

37,5x75 cm 14 3/4" x 29 1/2"
ANXW Klif White 37,5x75
ANXX Klif Silver 37,5x75
ANXY Klif Grey 37,5x75
ANXZ Klif Dark 37,5x75

GRIP SURFACE / SUPERFICIE GRIP

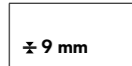

37,5x75 cm 14 3/4" x 29 1/2"
ANX0 Klif White 37,5x75 Grip
ANX1 Klif Silver 37,5x75 Grip
ANX2 Klif Grey 37,5x75 Grip
ANX3 Klif Dark 37,5x75 Grip

OUTDOOR PAVING ± 20 mm / PAVIMENTI DA ESTERNO ± 20 mm

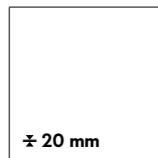

90x90 cm 35 3/8" x 35 3/8"
AOES Klif Silver 90x90 LASTRA 20 mm
AOET Klif Grey 90x90 LASTRA 20 mm
AOEU Klif Dark 90x90 LASTRA 20 mm

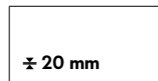

45x90 cm 17 3/4" x 35 3/8"
ANX7 Klif Silver 45x90 LASTRA 20 mm
ANX8 Klif Grey 45x90 LASTRA 20 mm
ANX9 Klif Dark 45x90 LASTRA 20 mm

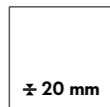

60x60 cm 23 3/4" x 23 3/4"
ANX4 Klif Silver 60x60 LASTRA 20 mm
ANX5 Klif Grey 60x60 LASTRA 20 mm
ANX6 Klif Dark 60x60 LASTRA 20 mm

MATTE / GRIP



WHITE



SILVER

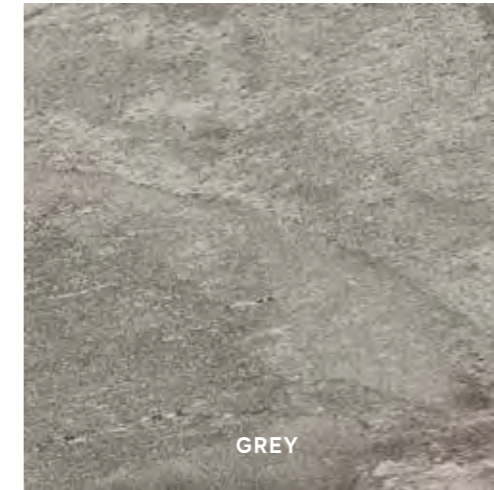

GREY



DARK

OUTDOOR PAVING ± 20 mm



SILVER



GREY



DARK



V3 MODERATE VARIATION

White,
Silver,
Grey,
Dark

MATTE SURFACE | SUPERFICIE MATT | Surface Mat | Matt oberfläche | Superficie Mate | Матовая поверхность
GRIP SURFACE | SUPERFICIE GRIP | Surface grip | Grip oberfläche | Superficie Grip | Grip поверхность
OUTDOOR PAVING | PAVIMENTI DA ESTERNO | Sols d'extérieur | Bodenbeläge für Außenbereiche | Pavimentos para exteriores | Уличная плитка

Klif Porcelain Tiles / Gres Porcellanato

DECOR RANGE / GAMMA DECORI



AN46 Klif White Mosaico
30x30 - 11³/₄"x11³/₄"



AN47 Klif Silver Mosaico
30x30 - 11³/₄"x11³/₄"

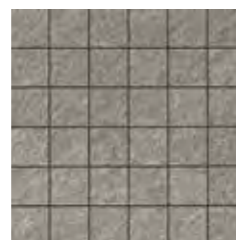

AN48 Klif Grey Mosaico
30x30 - 11³/₄"x11³/₄"

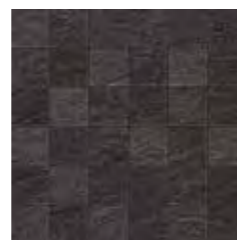

AN49 Klif Dark Mosaico
30x30 - 11³/₄"x11³/₄"

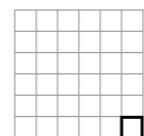

4,8x4,8 cm
1⁷/₈"x1⁷/₈"



AN7G Klif White Triangles
28,5x33 - 11¹/₄"x13"



AN7H Klif Silver Triangles
28,5x33 - 11¹/₄"x13"



AN7I Klif Grey Triangles
28,5x33 - 11¹/₄"x13"



AN7J Klif Dark Triangles
28,5x33 - 11¹/₄"x13"

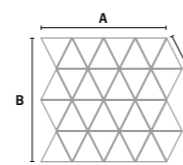

A 32,8 cm - 13"
B 28,5 cm - 11¹/₄"
C 7,9 cm - 3¹/₈"



AN7C Klif White Brick
37,5x75 - 14³/₄"x29¹/₂"



AN7D Klif Silver Brick
37,5x75 - 14³/₄"x29¹/₂"



AN7E Klif Grey Brick
37,5x75 - 14³/₄"x29¹/₂"



AN7F Klif Dark Brick
37,5x75 - 14³/₄"x29¹/₂"

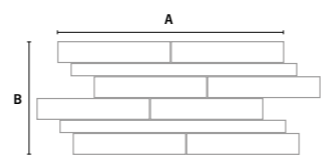

A 74,8 cm - 29¹/₂"
B 37,4 cm - 11³/₄"



AN7K Klif White Brick 3D
28x55 - 11"x21⁵/₈"



AN7L Klif Silver Brick 3D
28x55 - 11"x21⁵/₈"



AN7M Klif Grey Brick 3D
28x55 - 11"x21⁵/₈"



AN7N Klif Dark Brick 3D
28x55 - 11"x21⁵/₈"

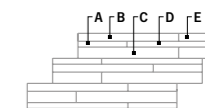





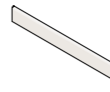
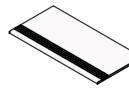
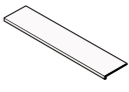
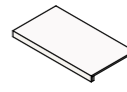
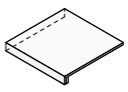

A 18x2,1 cm - 7¹/₈"x¹/₈"
B 37x2,9 cm - 14³/₈"x1¹/₈"
C 37x4,2 cm - 14⁷/₈"x1¹/₈"
D 37x2,1 cm - 14⁷/₈"x¹/₈"
E 18x2,9 cm - 7¹/₈"x1¹/₈"
F 18x4,2 cm - 7¹/₈"x1¹/₈"

TRIM TILES / PEZZI SPECIALI

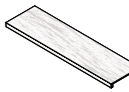
p. 424

UPEC p. 571

									
		Battiscopa 7,2x75 2 ⁷ / ₈ "x29 ¹ / ₂ "	Gradino * 37,5x75 14 ³ / ₄ "x29 ¹ / ₂ "	Scalino * 37,5x150 14 ³ / ₄ "x59"	Scalino * 37,5x75 14 ³ / ₄ "x29 ¹ / ₂ "	Scalino Angolare * 37,5x37,5 14 ³ / ₄ "x14 ³ / ₄ "	Battiscopa Sag. Scala 7,2x30 - 2 ⁷ / ₈ "x11 ³ / ₄ "		Elemento L Grip 15x75 H.4 cm 5 ⁷ / ₈ "x29 ¹ / ₂ " H.1 ⁵ / ₈ "
							DX *	SX *	
	White	AN4F	AN4P	AN4T	AN4X	AN42	AN4H	AN4L	AN5A
	Silver	AN2R	AN4Q	AN4U	AN4Y	AN43	AN4I	AN4M	AN5B
	Grey	AN2S	AMG4	AN4V	AN4Z	AN44	AN4J	AN4N	AN5C
	Dark	AN4G	AN4S	AN4W	AN41	AN45	AN4K	AN4O	AN5D

* THESE PARTS ARE SUPPLIED TO ORDER | I PEZZI SONO DISPONIBILI SU ORDINAZIONE | Les pièces sont disponibles sur commande | Die Teile sind auf Bestellung lieferbar | Las piezas se hacen por encargo | Изготавливаются на заказ

 THE DECORATION CAN ONLY BE LAID ON THE WALL | IL DECORO SI PUÒ POSARE SOLO A RIVESTIMENTO
Décor uniquement mural | Das Dekor kann nur an der Wand verlegt werden | La decoración se puede colocar únicamente en paredes | Декор может быть уложен только на стену.



Klif Wall Tiles / Rivestimento

MATTE SURFACE / SUPERFICIE MATT

WALL TILES p. 486

± 8,5 mm

40x80 cm 15³/₄"x31¹/₂"
8K8W Klif White 40x80
8K8S Klif Silver 40x80
8K8G Klif Grey 40x80

3D WALL TILES / RIVESTIMENTO 3D

± 10 mm

40x80 cm 15³/₄"x31¹/₂"
8KRW Klif 3D Row White 40x80
8KRS Klif 3D Row Silver 40x80
8KRG Klif 3D Row Grey 40x80

TRIM TILES / PEZZI SPECIALI



1,4x40 cm - 5⁵/₈"x15³/₄"
LK4W Klif White Corner 40 •
LK4S Klif Silver Corner 40 •
LK4G Klif Grey Corner 40 •



1,4x1,4 cm - 5⁵/₈"x5⁵/₈"
AKCW Klif White Corner A.E. •
AKCL Klif Silver Corner A.E. •
AKCG Klif Grey Corner A.E. •

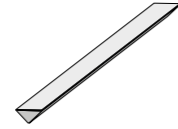

1,4x40 cm - 5⁵/₈"x15³/₄"
LY3W Klif 3D White Corner 40 •
LY3S Klif 3D Silver Corner 40 •
LY3G Klif 3D Grey Corner 40 •

* THESE PARTS ARE SUPPLIED TO ORDER . I PEZZI SONO DISPONIBILI SU ORDINAZIONE
Les pièces sont disponibles sur commande | Die Teile sind auf Bestellung lieferbar | Las piezas se hacen por encargo | Изготавливаются на заказ



MATTE SURFACE | SUPERFICIE MATT | Surface Mat | Matt oberfläche | Superficie Mate | Матовая поверхность



WHITE



3D ROW WHITE



SILVER



3D ROW SILVER



GREY



3D ROW GREY



**V2
SLIGHT
VARIATION**

White,
Silver,
Grey,
3D Row White
3D Row Silver
3D Row Grey

STONE LOOK

267

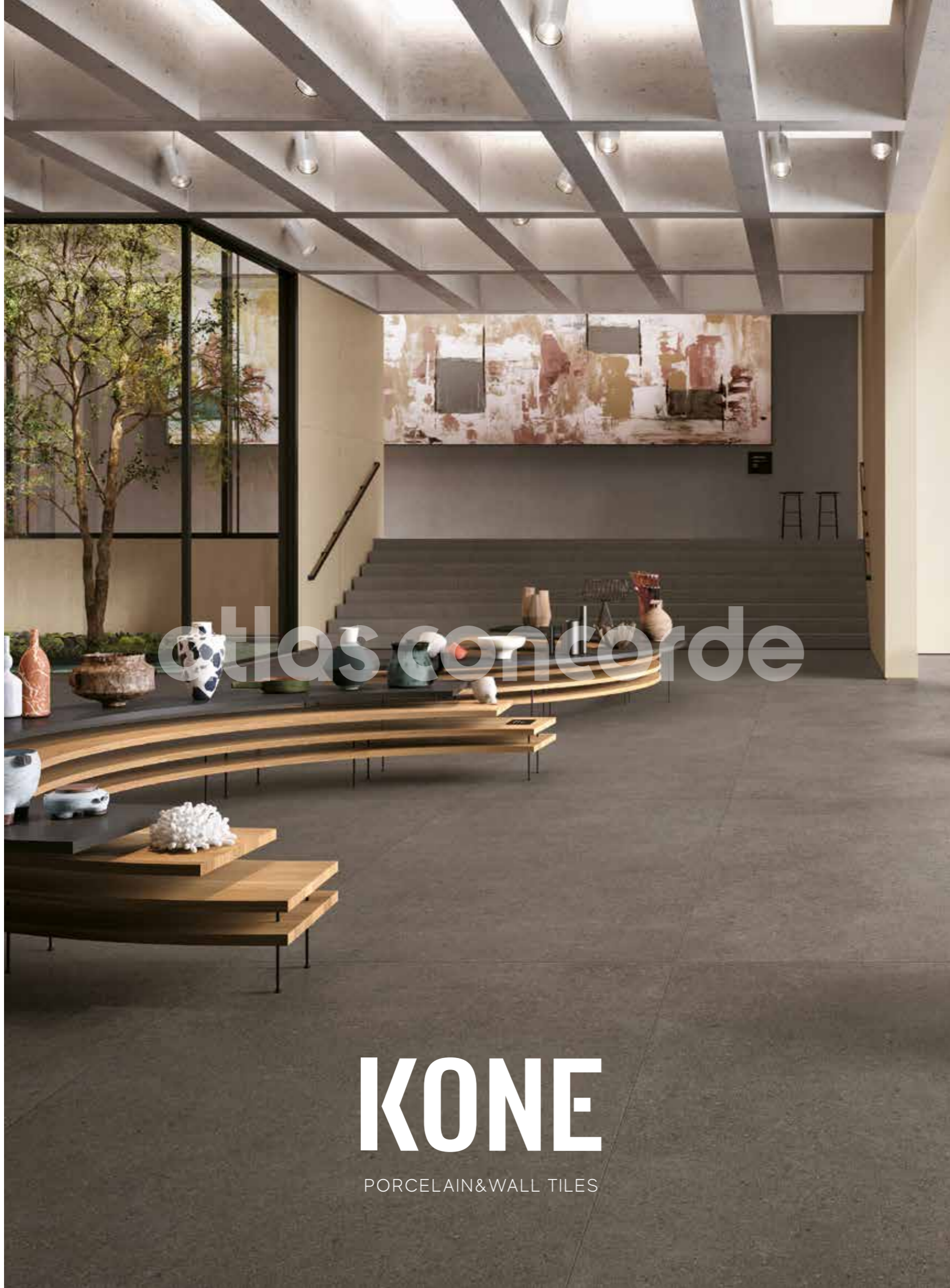

KONE

PORCELAIN&WALL TILES

Porcelain Tiles / Gres Porcellanato

COLOURED BODY PORCELAIN TILES - RECTIFIED MONOCALIBER
GRES PORCELLANATO COLORATO IN MASSA - RETTIFICATO MONOCALIBRO

LARGE SIZES p. 366



Sizes	Thickness	Surface finish
162x324 cm - 63 ³ / ₄ "x127 ¹ / ₂ " NON RECTIFIED - NON RETTIFICATO	± 6-12 mm	Matte
120x278 cm - 47 ¹ / ₄ "x109 ¹ / ₂ "	± 6 mm	Matte R9 A
120x240 cm - 47 ¹ / ₄ "x94 ¹ / ₂ "	± 9 mm	Matte R10 A
120x120 cm - 47 ¹ / ₄ "x47 ¹ / ₄ "	± 9 mm	Matte R10 A
75x150 cm - 29 ¹ / ₂ "x59"	± 9 mm	Polished, Matte R10 A
75x75 cm - 29 ¹ / ₂ "x29 ¹ / ₂ "	± 9 mm	Polished, Matte R10 A
45x90 cm - 17 ³ / ₄ "x35 ³ / ₈ "	± 9 mm	Matte R10 A
60x60 cm - 23 ⁵ / ₈ "x23 ⁵ / ₈ "	± 9 mm	Polished, Matte R10 A
30x60 cm - 11 ³ / ₄ "x23 ⁵ / ₈ "	± 9 mm	Polished, Matte R10 A

Outdoor Paving and Wet Areas

OUTDOOR PAVING p. 408

Sizes	Thickness	Surface finish
30x60 cm - 11 ³ / ₄ "x23 ⁵ / ₈ "	± 9 mm	Grip R11 A+B
45x90 cm - 17 ³ / ₄ "x35 ³ / ₈ "	± 20 mm	Textured R11 A+B+C
60x60 cm - 23 ⁵ / ₈ "x23 ⁵ / ₈ "	± 20 mm	Textured R11 A+B+C

Wall Tiles / Rivestimento p. 490

WHITEBODY WALL TILES - RECTIFIED MONOCALIBER
RIVESTIMENTI IN PASTA BIANCA - RETTIFICATO MONOCALIBRO



Sizes	Thickness	Surface finish
50x110 cm - 19 ⁵ / ₈ "x43 ¹ / ₄ "	± 8,5 mm	Matte
40x80 cm - 15 ³ / ₄ "x31 ¹ / ₂ "	± 8,5 mm	Matte

3D Wall Tiles

Sizes	Thickness	Surface finish
50x110 cm - 19 ⁵ / ₈ "x43 ¹ / ₄ "	± 11 mm	Matte
40x80 cm - 15 ³ / ₄ "x31 ¹ / ₂ "	± 10 mm	Matte



Kone Porcelain Tiles / Gres Porcellanato

MATTE SURFACE / SUPERFICIE MATT



120x278 cm 47 1/4" x 109 1/2"
A0BR Kone White 120x278 Matt
A0BQ Kone Pearl 120x278 Matt



MATTE / MATT
162x324 cm 63 3/4" x 127 1/2"
> **NON RECTIFIED / NON RETTIFICATO**
AN1R Kone Grey Matt ± 6 mm
AN1T Kone Grey Matt ± 6 mm ST *
AN1P Kone Mix Matt ± 6 mm
AN1Q Kone Mix Matt ± 6 mm ST *
AMSQ Kone Mix Matt ± 12 mm
AMXS Kone Mix Matt ± 12 mm ST *
ANXI Kone Grey Matt ± 12 mm
ANXH Kone Grey Matt ± 12 mm ST *
AMKC Kone Gypsum Matt ± 12 mm
AMKD Kone Gypsum Matt ± 12 mm ST *



120x240 cm 47 1/4" x 94 1/2"
AULR Kone White 120x240
AULS Kone Pearl 120x240
AULT Kone Grey 120x240

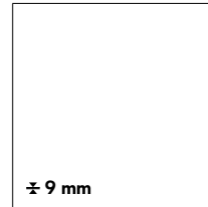

120x120 cm 47 1/4" x 47 1/4"
AULO Kone White 120x120
AULP Kone Pearl 120x120
AULQ Kone Grey 120x120

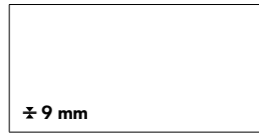

75x150 cm 29 1/2" x 59"
AUKB Kone White 75x150
AUKC Kone Beige 75x150
AUKD Kone Silver 75x150
AUK E Kone Pearl 75x150
AUKF Kone Grey 75x150
AAPT Kone Mix 75x150

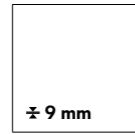

75x75 cm 29 1/2" x 29 1/2"
AUKT Kone White 75x75
AUKU Kone Beige 75x75
AUKV Kone Silver 75x75
AUKW Kone Pearl 75x75
AUKX Kone Grey 75x75

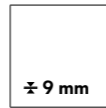

60x60 cm 23 5/8" x 23 5/8"
AUK8 Kone White 60x60
AUK9 Kone Beige 60x60
AULA Kone Silver 60x60
AULB Kone Pearl 60x60
AULC Kone Grey 60x60

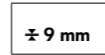

30x60 cm 11 3/4" x 23 5/8"
D216 Kone White 30x60
D217 Kone Beige 30x60
D218 Kone Silver 30x60
D219 Kone Pearl 30x60
D220 Kone Grey 30x60

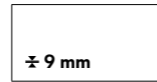

45x90 cm 17 3/4" x 35 3/8"
AUK3 Kone White 45x90
AUK4 Kone Beige 45x90
AUK5 Kone Silver 45x90
AUK6 Kone Pearl 45x90
AUK7 Kone Grey 45x90



GRIP SURFACE / SUPERFICIE GRIP



30x60 cm 11 3/4" x 23 5/8"
D221 Kone White 30x60 Grip
D222 Kone Beige 30x60 Grip
D223 Kone Silver 30x60 Grip
D224 Kone Pearl 30x60 Grip
D225 Kone Grey 30x60 Grip



OUTDOOR PAVING ± 20 mm / PAVIMENTI DA ESTERNO ± 20 mm

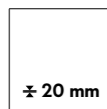

60x60 cm 23 5/8" x 23 5/8"
AULY Kone Pearl 60x60 LASTRA 20 mm
AULZ Kone Grey 60x60 LASTRA 20 mm

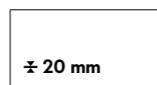

45x90 cm 17 3/4" x 35 3/8"
AULV Kone Pearl 45x90 LASTRA 20 mm
AULW Kone Grey 45x90 LASTRA 20 mm

MATTE SURFACE | SUPERFICIE MATT | Surface Mat | Matt oberfläche | Superficie Mate | Матовая поверхность
GRIP SURFACE | SUPERFICIE GRIP | Surface grip | Grip oberfläche | Superficie Grip | Grip поверхность
OUTDOOR PAVING | PAVIMENTI DA ESTERNO | Sols d'extérieur | Bodenbeläge für Außenbereiche | Pavimentos para exteriores | Уличная плитка
*** WITH FIBERGLASS MESH** | VERSIONE STUOIATA | Version à nattes | Ausführung mit Glasfasermatte | Versión con malla | С упрочнением из стекловолокна
NON RECTIFIED | NON RETTIFICATO | Non rectifié | Nicht rektifiziert | No rectificada | Неретифицированные

MATTE / GRIP

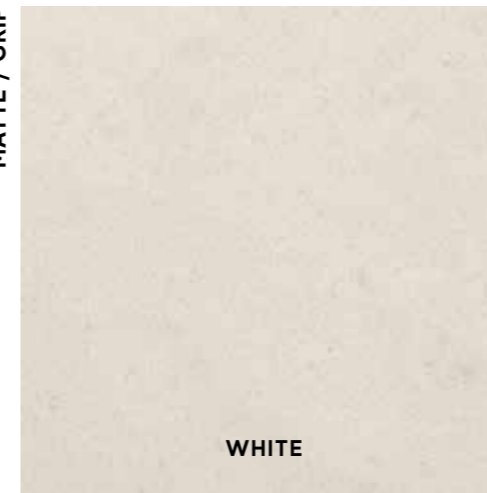

WHITE



BEIGE



PEARL



SILVER



GREY



MIX

OUTDOOR PAVING ± 20 mm



PEARL



GREY



V2 SLIGHT VARIATION

White, Beige, Pearl, Silver, Grey, Mix



Kone Porcelain Tiles / Gres Porcellanato

POLISHED SURFACE / SUPERFICIE LAPPATA



75x150 cm 29¹/₂"x59"

- AUKG Kone White 75x150 Lappato
- AUKH Kone Beige 75x150 Lappato
- AUKI Kone Silver 75x150 Lappato
- AUKJ Kone Pearl 75x150 Lappato
- AUKK Kone Grey 75x150 Lappato
- AAPS Kone Mix 75x150 Lappato

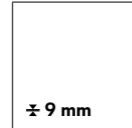

75x75 cm 29¹/₂"x29¹/₂"

- AUKY Kone White 75x75 Lappato
- AUKZ Kone Beige 75x75 Lappato
- AUKØ Kone Silver 75x75 Lappato
- AUK1 Kone Pearl 75x75 Lappato
- AUK2 Kone Grey 75x75 Lappato

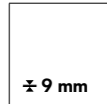

60x60 cm 23⁵/₈"x23⁵/₈"

- AUJZ Kone White 60x60 Lappato
- AUJØ Kone Beige 60x60 Lappato
- AUJ1 Kone Silver 60x60 Lappato
- AUJ2 Kone Pearl 60x60 Lappato
- AUJY Kone Grey 60x60 Lappato

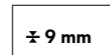

30x60 cm 11³/₄"x23⁵/₈"

- D2ØØ Kone White 30x60 Lappato
- D2Ø1 Kone Beige 30x60 Lappato
- D2Ø2 Kone Silver 30x60 Lappato
- D2Ø3 Kone Pearl 30x60 Lappato
- D2Ø4 Kone Grey 30x60 Lappato



The glossy polished finish is suitable for residential or low-traffic commercial floors, where no anti-slip performance is required, and for walls. The glossy polished surface finish, surprisingly brilliant and bright, features slight irregularities. The extraordinary brilliance and the easy cleaning of the surface are the result of in-depth research aimed at guaranteeing its durability over time. If the product is in direct contact with the outdoors, provide devices for absorbing moisture and dirt to prevent scratches. / La finitura Lappata lucida è indicata per pavimenti residenziali o commerciali poco sollecitati, laddove non siano richieste prestazioni antiscivolo, e per rivestimenti. La finitura lappata lucida offre una superficie sorprendentemente brillante e specchiante, con lievi irregolarità. La straordinaria lucentezza e l'elevata pulibilità della superficie sono frutto di studi approfonditi e accurate ricerche tecniche volte a garantirne la persistenza nel tempo. Se il prodotto è a diretto contatto con l'esterno, prevedere dei dispositivi di assorbimento dell'umidità e della sporcizia per prevenire la formazione di graffi.

POLISHED SURFACE | SUPERFICIE LAPPATA | Surface adouci | Geläpft oberfläche | Superficie bruñido | Полуполированный поверхность



WHITE



BEIGE



PEARL



SILVER



GREY



MIX



V2 SLIGHT VARIATION

White, Beige, Pearl, Silver, Grey, Mix

Kone Porcelain Tiles / Gres Porcellanato

DECOR RANGE / GAMMA DECORI

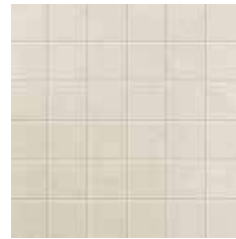

AUNR Kone White Mosaico
30x30 - 11³/₄"x11³/₄"

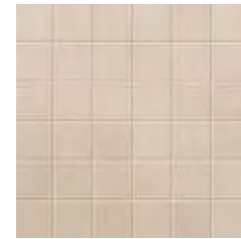

AUNS Kone Beige Mosaico
30x30 - 11³/₄"x11³/₄"



AUNT Kone Silver Mosaico
30x30 - 11³/₄"x11³/₄"



AUNU Kone Pearl Mosaico
30x30 - 11³/₄"x11³/₄"

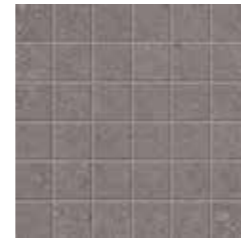

AUNV Kone Grey Mosaico
30x30 - 11³/₄"x11³/₄"



AARA Kone Warm Industrial 3D
31,5x45 - 12³/₈"x17³/₈"



AAQ9 Kone Cold Industrial 3D
31,5x45 - 12³/₈"x17³/₈"



AUN9 Kone White Mosaico Pinnacle 3D
30x30 - 11³/₄"x11³/₄"



AUOA Kone Beige Mosaico Pinnacle 3D
30x30 - 11³/₄"x11³/₄"

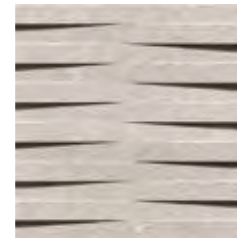

AUOB Kone Silver Mosaico Pinnacle 3D
30x30 - 11³/₄"x11³/₄"

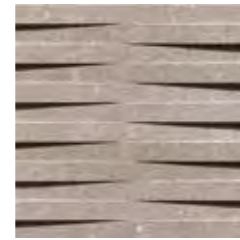

AUOC Kone Pearl Mosaico Pinnacle 3D
30x30 - 11³/₄"x11³/₄"

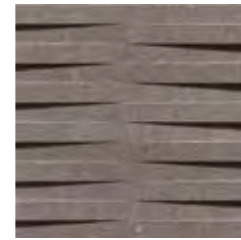

AUOD Kone Grey Mosaico Pinnacle 3D
30x30 - 11³/₄"x11³/₄"



AUOO Kone White Chevron
11,5x67 - 4¹/₂"x26³/₈"



AUOR Kone Pearl Chevron
11,5x67 - 4¹/₂"x26³/₈"



AUOP Kone Beige Chevron
11,5x67 - 4¹/₂"x26³/₈"



AUOS Kone Grey Chevron
11,5x67 - 4¹/₂"x26³/₈"



AUOJ Kone White Mosaico Brick
30,4x30,4 - 12"x12"



AUOK Kone Beige Mosaico Brick
30,4x30,4 - 12"x12"



AUOL Kone Silver Mosaico Brick
30,4x30,4 - 12"x12"



AUOM Kone Pearl Mosaico Brick
30,4x30,4 - 12"x12"



AUON Kone Grey Mosaico Brick
30,4x30,4 - 12"x12"



AUN1 Kone White Mosaico Esagono
30x35 - 11³/₄"x13³/₄"



AUN2 Kone Beige Mosaico Esagono
30x35 - 11³/₄"x13³/₄"



AUN3 Kone Silver Mosaico Esagono
30x35 - 11³/₄"x13³/₄"



AUN4 Kone Pearl Mosaico Esagono
30x35 - 11³/₄"x13³/₄"



AUN5 Kone Grey Mosaico Esagono
30x35 - 11³/₄"x13³/₄"

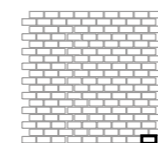

1,5x3,2 cm
5/8"x1 1/4"

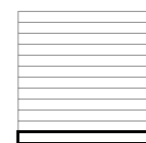

29,6x2,5 cm
11 5/8"x1"

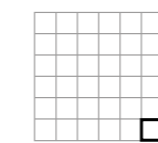

4,8x4,8 cm
1 7/8"x1 7/8"

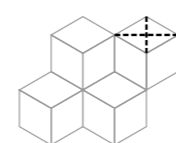

10x17 cm
3 7/8"x6 1/4"

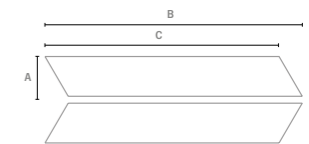

A 11,5 cm - 4 1/2"
B 73,6 cm - 29"
C 67 cm - 26 3/8"

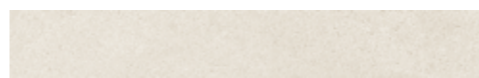

AUNM Kone White Listello
8x60 - 3 1/8"x23 5/8"



AUNN Kone Beige Listello
8x60 - 3 1/8"x23 5/8"



AUNO Kone Silver Listello
8x60 - 3 1/8"x23 5/8"



AUNP Kone Pearl Listello
8x60 - 3 1/8"x23 5/8"



AUNQ Kone Grey Listello
8x60 - 3 1/8"x23 5/8"

THE DECORATION CAN ONLY BE LAID ON THE WALL | IL DECORO SI PUÒ POSARE SOLO A RIVESTIMENTO
Décor uniquement mural | Das Dekor kann nur an der Wand verlegt werden | La decoración se puede colocar únicamente en paredes | Декор может быть уложен только на стену.

Kone Porcelain Tiles / Gres Porcellanato

DECOR RANGE / GAMMA DECORI



AUOE Kone White Linea 3D
30x60 - 11³/₄"x23⁵/₈"



AUOH Kone Pearl Linea 3D
30x60 - 11³/₄"x23⁵/₈"



AUOF Kone Beige Linea 3D
30x60 - 11³/₄"x23⁵/₈"



AUOI Kone Grey Linea 3D
30x60 - 11³/₄"x23⁵/₈"



AUOG Kone Silver Linea 3D
30x60 - 11³/₄"x23⁵/₈"

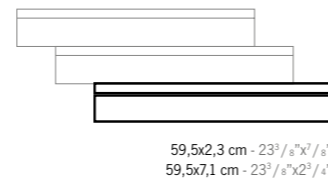

AUNW Kone White Brick
30x60 - 11³/₄"x23⁵/₈"



AUNZ Kone Pearl Brick
30x60 - 11³/₄"x23⁵/₈"



AUNX Kone Beige Brick
30x60 - 11³/₄"x23⁵/₈"



AUNØ Kone Grey Brick
30x60 - 11³/₄"x23⁵/₈"



AUNY Kone Silver Brick
30x60 - 11³/₄"x23⁵/₈"

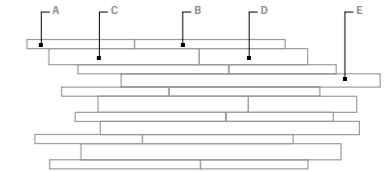

A 2,1x24,8 cm - 3/4"x9 7/8"
B 2,1x34,5 cm - 1/4"x13 5/8"
C 3,3x34,5 cm - 1 1/4"x13 5/8"
D 3,3x24,8 cm - 1 1/4"x9 7/8"
E 2,5x60 cm - 1"x23 5/8"



atlas concoroe

TRIM TILES / PEZZI SPECIALI

p. 424

UPEC p. 571

	Battiscopa 7,2x60 2 ⁷ / ₈ "x23 ⁵ / ₈ "	Gradino * 30x60 11 ³ / ₄ "x23 ⁵ / ₈ "	Scalino * 33x150 13"x59"	Scalino * 33x90 13"x35 ³ / ₈ "	Scalino * 33x75 13"x29 ¹ / ₂ "	Scalino * 33x60 13"x23 ⁵ / ₈ "	Scalino Angolare * 33x33 13"x13"	Battiscopa Sag. Scala 7,2x30 - 2 ⁷ / ₈ "x11 ³ / ₄ "		Elemento L Grip * 15x60 H. 4 5 ⁷ / ₈ "x23 ⁵ / ₈ " H. 1 ¹ / ₈ "
								DX *	SX *	
White	AUOT	AUP6	A8N7	AAK8	AALE	AAK3	AALK	AU03	AUOY	AAQ4
Beige	AUOU	AUP7	A8N8	AAK9	AALG	AAK4	AALL	AU04	AUOZ	AAQ5
Silver	AUOV	AUP8	A8N9	AALA	AALH	AAK5	AALM	AU05	AUOØ	AAQ6
Pearl	AUOW	AUP9	A80A	AALB	AALI	AAK6	AALN	AU06	AU01	AAQ7
Grey	AUOX	AUQA	A80B	AALD	AALJ	AAK7	AALO	AU07	AU02	AAQ8

* THESE PARTS ARE SUPPLIED TO ORDER | I PEZZI SONO DISPONIBILI SU ORDINAZIONE | Les pièces sont disponibles sur commande | Die Teile sind auf Bestellung lieferbar | Las piezas se hacen por encargo | Изготавливаются на заказ

THE DECORATION CAN ONLY BE LAID ON THE WALL | IL DECORO SI PUÒ POSARE SOLO A RIVESTIMENTO
Décor uniquement mural | Das Dekor kann nur an der Wand verlegt werden | La decoración se puede colocar únicamente en paredes | Декор может быть уложен только на стену.



Kone Wall Tiles / Rivestimento

WALL TILES p. 490

MATTE SURFACE / SUPERFICIE MATT



50x110 cm 19⁵/₈"x43¹/₄"
4K1W Kone White 50x110
4K1B Kone Beige 50x110
4K1S Kone Silver 50x110



40x80 cm 15³/₄"x31¹/₂"
8K4W Kone White 40x80
8K4B Kone Beige 40x80
8K4S Kone Silver 40x80

TRIM TILES / PEZZI SPECIALI

LKSW Kone White Spigolo
0,8x20 cm - 3¹/₈"x7⁷/₈"

AKSW Kone White Spigolo A.E.
0,8x0,8 cm - 3¹/₈"x3³/₈"

LKSE Kone Beige Spigolo
0,8x20 cm - 3¹/₈"x7⁷/₈"

AKSB Kone Beige Spigolo A.E.
0,8x0,8 cm - 3¹/₈"x3³/₈"

LKSS Kone Silver Spigolo
0,8x20 cm - 3¹/₈"x7⁷/₈"

AKSS Kone Silver Spigolo A.E.
0,8x0,8 cm - 3¹/₈"x3³/₈"

3D WALL TILES / RIVESTIMENTO 3D



50x110 cm 19⁵/₈"x43¹/₄"
4K3W Kone 3D Line White 50x110
4K3S Kone 3D Line Silver 50x110



40x80 cm 15³/₄"x31¹/₂"
8K3W Kone 3D Stars White 40x80
8K3S Kone 3D Stars Silver 40x80

LK1W Kone White Spigolo 10mm *
1x20 cm - 3¹/₈"x7⁷/₈"

LK1S Kone Silver Spigolo 10mm *
1x20 cm - 3¹/₈"x7⁷/₈"

DECORATIVE RANGE / GAMMA DECORATIVA



MOSAIC

* THESE PARTS ARE SUPPLIED TO ORDER . I PEZZI SONO DISPONIBILI SU ORDINAZIONE
Les pièces sont disponibles sur commande | Die Teile sind auf Bestellung lieferbar | Las piezas se hacen por encargo | Изготавливаются на заказ

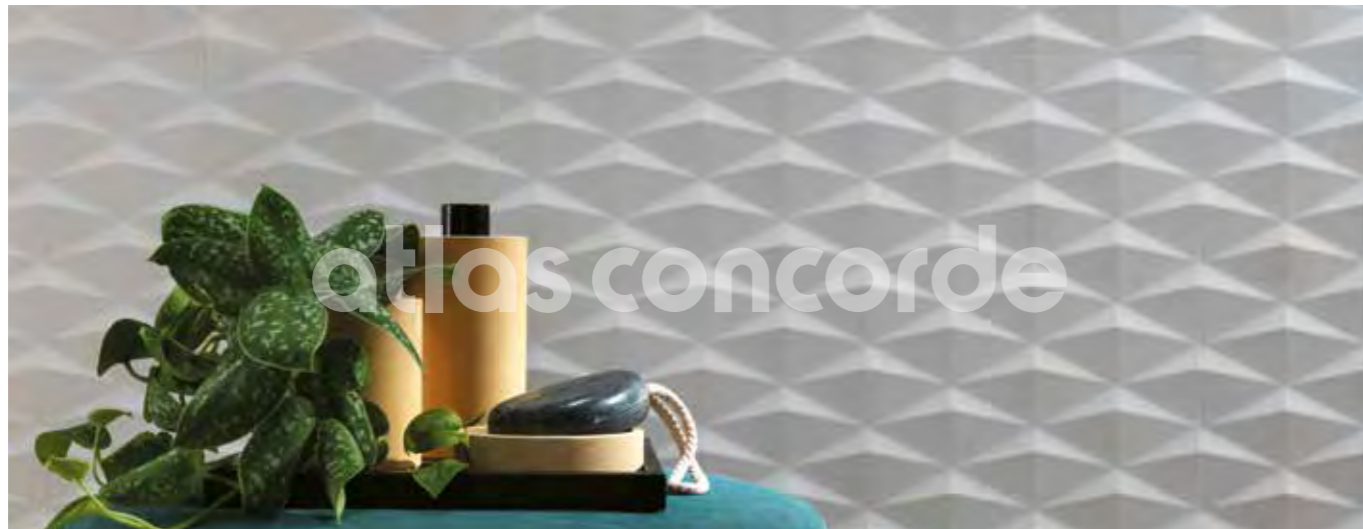

The 10 mm edge matches three-dimensional wall tiles having a 10-11 mm thickness. / Lo spigolo 10 mm si abbina a rivestimenti tridimensionali di spessore 10-11 mm. / Le bord 10 mm s'adapte aux revêtements tridimensionnels épaisseur 10-11 mm. / Die 10 mm Kante ist mit dreidimensionalen Wandfliesen mit einer Dicke von 10-11 mm kombinierbar. / La arista de 10 mm se combina con revestimientos tridimensionales de 10 -11 mm de grosor. / Угловой элемент 10 мм сочетается с трехмерной настенной плиткой толщиной 10-11 мм.

MATTE SURFACE | SUPERFICIE MATT | Surface Mat | Matt oberfläche | Superficie Mate | Матовая поверхность

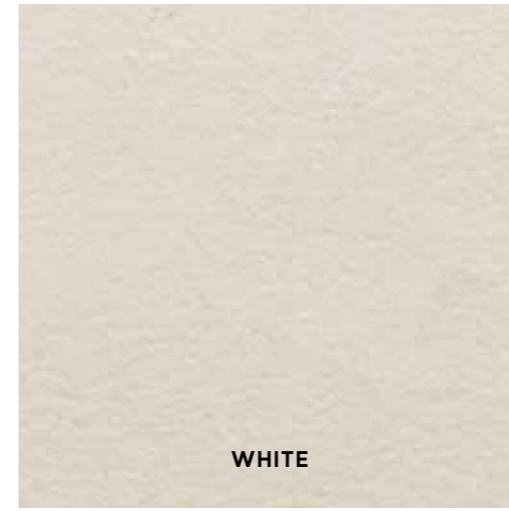

WHITE



3D STARS WHITE



3D LINE WHITE



SILVER



3D STARS SILVER



3D LINE SILVER



BEIGE



V2 SLIGHT VARIATION
White,
Silver,
Beige
3D Stars Silver,
3D Stars White,
3D Line White,
3D Line Silver

MARVEL

STONE

PORCELAIN&WALL TILES

Porcelain Tiles / Gres Porcellanato

COLOURED BODY PORCELAIN TILES - RECTIFIED MONOCALIBER
GRES PORCELLANATO COLORATO IN MASSA - RETTIFICATO MONOCALIBRO

LARGE SIZES p. 366



Sizes	Thickness	Surface finish
162x324 cm - 63 ³ / ₄ "x127 ¹ / ₂ " NON RECTIFIED - NON RETTIFICATO	± 6-12-20 mm	Matte
120x240 cm - 47 ¹ / ₄ "x94 ¹ / ₂ "	± 9 mm	Matte R9 A
120x120 cm - 47 ¹ / ₄ "x47 ¹ / ₄ "	± 9 mm	Matte R9 A
75x150 cm - 29 ¹ / ₂ "x59"	± 9 mm	Matte R9 A
75x75 cm - 29 ¹ / ₂ "x29 ¹ / ₂ "	± 9 mm	Matte R9 A
45x90 cm - 17 ³ / ₄ "x35 ³ / ₈ "	± 9 mm	Matte R9 A
60x60 cm - 23 ⁵ / ₈ "x23 ⁵ / ₈ "	± 9 mm	Matte R9 A
30x60 cm - 11 ³ / ₄ "x23 ⁵ / ₈ "	± 9 mm	Matte R9 A

Outdoor Paving and Wet Areas

OUTDOOR PAVING p. 408

Sizes	Thickness	Surface finish
30x60 cm - 11 ³ / ₄ "x23 ⁵ / ₈ "	± 9 mm	Textured R11 A+B+C
60x120 cm - 23 ⁵ / ₈ "x47 ¹ / ₄ "	± 20 mm	Textured R11 A+B+C

MARVEL STONE COLLECTION
MARBLE LOOK p. 222



Wall Tiles / Rivestimento p. 524

WHITEBODY WALL TILES - RECTIFIED MONOCALIBER
RIVESTIMENTI IN PASTA BIANCA - RETTIFICATO MONOCALIBRO

Sizes	Thickness	Surface finish
50x110 cm - 19 ⁵ / ₈ "x43 ¹ / ₄ "	± 8,5 mm	Matte
40x80 cm - 15 ³ / ₄ "x31 ¹ / ₂ "	± 8,5 mm	Matte

3D Wall Tiles

Sizes	Thickness	Surface finish
50x110 cm - 19 ⁵ / ₈ "x43 ¹ / ₄ "	± 11 mm	Matte
40x80 cm - 15 ³ / ₄ "x31 ¹ / ₂ "	± 10 mm	Matte



Marvel Stone Porcelain Tiles / Gres Porcellanato

MATTE SURFACE / SUPERFICIE MATT



120x240 cm 47 1/4" x 94 1/2"
AZT2 Marvel Clauzetto White 120x240
AZT1 Marvel Cardoso Elegant 120x240
AZT0 Marvel Basaltina Volcano 120x240

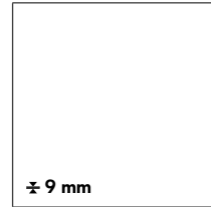

120x120 cm 47 1/4" x 47 1/4"
AZT5 Marvel Clauzetto White 120x120
AZT4 Marvel Cardoso Elegant 120x120
AZT3 Marvel Basaltina Volcano 120x120



MATTE / MATT
162x324 cm 63 3/4" x 127 1/2"
► **NON RECTIFIED / NON RETTIFICATO**
AL9Y Basaltina Volcano Matt ± 6 mm
AL9Z Basaltina Volcano Matt ± 6 mm ST *
ANRI Basaltina Volcano Matt ± 12 mm
ANVI Basaltina Volcano Matt ± 12 mm ST *
A2XS Basaltina Volcano Matt ± 20 mm



75x150 cm 29 1/2" x 59"
AZNQ Marvel Clauzetto White 75x150
AZNP Marvel Desert Beige 75x150
AZNO Marvel Cardoso Elegant 75x150
AZNN Marvel Basaltina Volcano 75x150

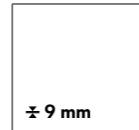

75x75 cm 29 1/2" x 29 1/2"
AZNV Marvel Clauzetto White 75x75
AZNU Marvel Desert Beige 75x75
AZNT Marvel Cardoso Elegant 75x75
AZNS Marvel Basaltina Volcano 75x75

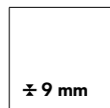

60x60 cm 23 5/8" x 23 5/8"
AZQ9 Marvel Clauzetto White 60x60
AZQ8 Marvel Desert Beige 60x60
AZQ7 Marvel Cardoso Elegant 60x60
AZQ6 Marvel Basaltina Volcano 60x60

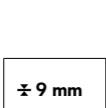

30x60 cm 11 3/4" x 23 5/8"
D118 Marvel Clauzetto White 30x60
D117 Marvel Desert Beige 30x60
D116 Marvel Cardoso Elegant 30x60
D115 Marvel Basaltina Volcano 30x60

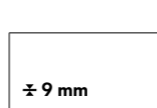

45x90 cm 17 3/4" x 35 5/8"
AZQ5 Marvel Clauzetto White 45x90
AZQ4 Marvel Desert Beige 45x90
AZQ3 Marvel Cardoso Elegant 45x90
AZQ2 Marvel Basaltina Volcano 45x90

TEXTURED SURFACE / SUPERFICIE STRUTTURATA

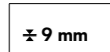

30x60 cm 11 3/4" x 23 5/8"
D123 Marvel Clauzetto White 30x60 Textured
D122 Marvel Desert Beige 30x60 Textured
D121 Marvel Cardoso Elegant 30x60 Textured
D119 Marvel Basaltina Volcano 30x60 Textured

OUTDOOR PAVING ± 20 mm / PAVIMENTI DA ESTERNO ± 20 mm

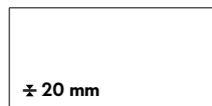

60x120 cm 23 5/8" x 47 1/4"
AZQM Marvel Clauzetto White 60x120 LASTRA 20 mm
AZQL Marvel Desert Beige 60x120 LASTRA 20 mm
AZQK Marvel Cardoso Elegant 60x120 LASTRA 20 mm
AZQJ Marvel Basaltina Volcano 60x120 LASTRA 20 mm

MATTE SURFACE | SUPERFICIE MATT | Surface Mat | Matt oberfläche | Superficie Mate | Матовая поверхность
TEXTURED SURFACE | SUPERFICIE STRUTTURATA | Surface structuré | Strukturiert oberfläche | Superficie estruturado | Структурная поверхность
OUTDOOR PAVING | PAVIMENTI DA ESTERNO | Sols d'extérieur | Außenbeläge für Außenbereiche | Pavimentos para exteriores | Уличная плитка
* **WITH FIBERGLASS MESH** | VERSIONE STUOIATA | Version à nattes | Ausführung mit Glasfasermatte | Versión con malla | С упрочнением из стекловолокна
NON RECTIFIED | NON RETTIFICATO | Non rectifié | Nicht rektifiziert | No rectificada | Неретифицированные

MATTE / GRIP



CLAUZETTO WHITE



DESERT BEIGE

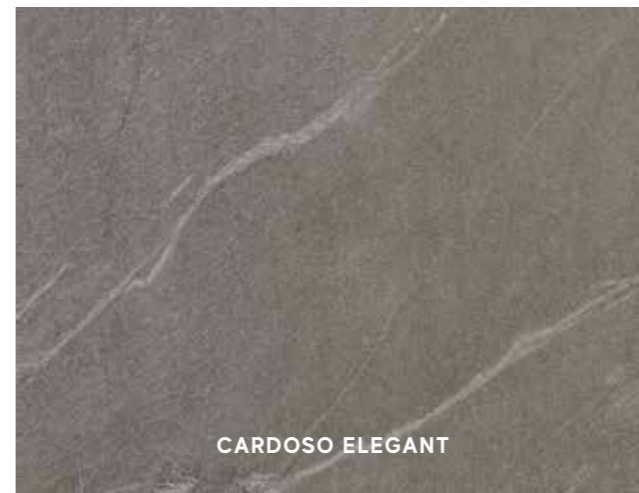

CARDOSO ELEGANT

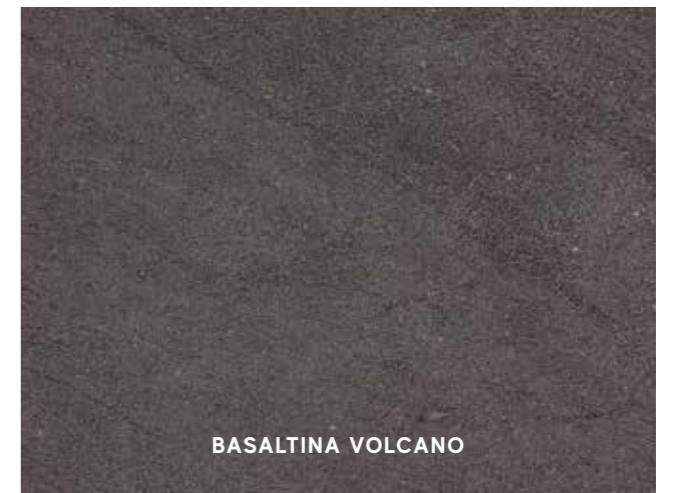

BASALTINA VOLCANO

OUTDOOR PAVING ± 20 mm



CLAUZETTO WHITE



DESERT BEIGE



CARDOSO ELEGANT



BASALTINA VOLCANO



V2 SLIGHT VARIATION
Clauzetto White,
Desert Beige,
Cardoso Elegant,
Basaltina Volcano

Marvel Stone Porcelain Tiles / Gres Porcellanato

DECOR RANGE / GAMMA DECORI

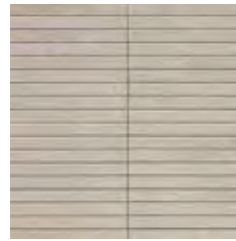

AS4J Marvel Clauzetto White Mosaico Bacchetta
30x30 - 11³/₄"x11³/₄"



AS4I Marvel Desert Beige Mosaico Bacchetta
30x30 - 11³/₄"x11³/₄"



AS4H Marvel Cardoso Elegant Mosaico Bacchetta
30x30 - 11³/₄"x11³/₄"



AS4G Marvel Basaltina Volcano Mosaico Bacchetta
30x30 - 11³/₄"x11³/₄"

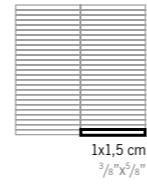

AS4N Marvel Clauzetto White Mosaico Burattato
29,8x29,8 - 11⁵/₈"x11⁵/₈"



AS4M Marvel Desert Beige Mosaico Burattato
29,8x29,8 - 11⁵/₈"x11⁵/₈"



AS4L Marvel Cardoso Elegant Mosaico Burattato
29,8x29,8 - 11⁵/₈"x11⁵/₈"



AS4K Marvel Basaltina Volcano Mosaico Burattato
29,8x29,8 - 11⁵/₈"x11⁵/₈"

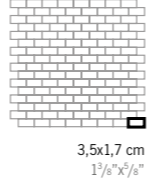

AS4F Marvel Clauzetto White Mosaico
30x30 - 11³/₄"x11³/₄"

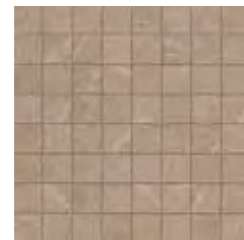

AS4E Marvel Desert Beige Mosaico
30x30 - 11³/₄"x11³/₄"

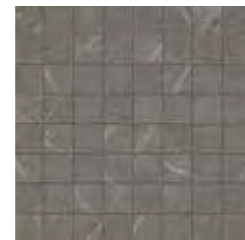

AS4D Marvel Cardoso Elegant Mosaico
30x30 - 11³/₄"x11³/₄"



AS4C Marvel Basaltina Volcano Mosaico
30x30 - 11³/₄"x11³/₄"

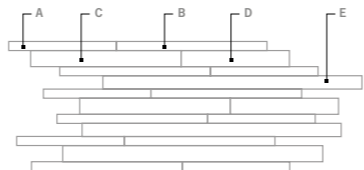
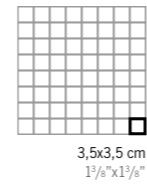

AS4S Marvel Clauzetto White Brick
30x60 - 11³/₄"x23⁵/₈"



AS4Q Marvel Desert Beige Brick
30x60 - 11³/₄"x23⁵/₈"



AS4P Marvel Cardoso Elegant Brick
30x60 - 11³/₄"x23⁵/₈"



AS4O Marvel Basaltina Volcano Brick
30x60 - 11³/₄"x23⁵/₈"

A 2,1x24,8 cm - 7/8"x9 1/2"
B 2,1x34,5 cm - 7/8"x13 3/8"
C 3,3x34,5 cm - 1 1/4"x13 3/8"
D 3,3x24,8 cm - 1 1/4"x9 1/2"
E 2,5x60 cm - 1"x23 5/8"



AS5A Marvel Clauzetto White Brick 3D
30x59 - 11³/₄"x23⁵/₈"



AS49 Marvel Desert Beige Brick 3D
30x59 - 11³/₄"x23⁵/₈"

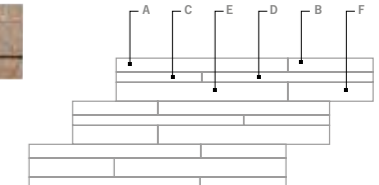

A 3,1x39,5 cm - 1 1/4"x15 1/2"
B 3,1x19,5 cm - 1 1/4"x7 7/8"
C 2,3x19,5 cm - 7/8"x7 7/8"
D 2,3x39,5 cm - 7/8"x15 1/2"
E 4,5x39,5 cm - 1 7/8"x15 1/2"
F 4,5x19,5 cm - 1 7/8"x7 7/8"



AS48 Marvel Cardoso Elegant Brick 3D
30x59 - 11³/₄"x23⁵/₈"



AS47 Marvel Basaltina Volcano Brick 3D
30x59 - 11³/₄"x23⁵/₈"



AS46 Marvel Clauzetto White Listello
7x60 - 2³/₄"x23⁵/₈"



AS45 Marvel Desert Beige Listello
7x60 - 2³/₄"x23⁵/₈"



AS44 Marvel Cardoso Elegant Listello
7x60 - 2³/₄"x23⁵/₈"



AS43 Marvel Basaltina Volcano Listello
7x60 - 2³/₄"x23⁵/₈"

TRIM TILES / PEZZI SPECIALI

p. 424

UPEC p. 571

	Battiscopa 7,2x60 2 ⁷ / ₈ "x23 ⁵ / ₈ "	Battiscopa Digitale 4,6x60 1 ³ / ₄ "x23 ⁵ / ₈ "	Gradino * 30x60 11 ³ / ₄ "x23 ⁵ / ₈ "	Scalino 150 * 33x150 13"x59"	Scalino 60 * 33x60 13"x23 ⁵ / ₈ "	Scalino Angolare 33x33 - 13"x13"	Battiscopa Sag. Scala 7,2x30 - 2 ⁷ / ₈ "x11 ³ / ₄ "	Elemento L Strutturato * 15x60 H. 4 5 ⁷ / ₈ "x23 ⁵ / ₈ " H. 1 ⁵ / ₈ "			
	DX *	SX *	DX *	SX *	DX *	SX *	DX *	SX *			
	Clauzetto White	ATFG	ATFC	ATFK	ATF6	ATGU	ATG2	ATGY	ATHR	ATHV	ATHZ
	Desert Beige	ATFF	ATFB	ATFJ	ATF5	ATF9	ATG1	ATGX	ATHQ	ATHU	ATHY
	Cardoso Elegant	ATFE	ATFA	ATFI	ATF4	ATF8	ATGØ	ATGW	ATHP	ATHT	ATHX
	Basaltina Volcano	ATFD	ATE9	ATFH	ATFL	ATF7	ATGZ	ATGV	ATHO	ATHS	ATHW

* THESE PARTS ARE SUPPLIED TO ORDER | I PEZZI SONO DISPONIBILI SU ORDINAZIONE | Les pièces sont disponibles sur commande | Die Teile sind auf Bestellung lieferbar | Las piezas se hacen por encargo | Изготавливаются на заказ

THE DECORATION CAN ONLY BE LAID ON THE WALL | IL DECORO SI PUÒ POSARE SOLO A RIVESTIMENTO
Décor uniquement mural | Das Dekor kann nur an der Wand verlegt werden | La decoración se puede colocar únicamente en paredes | Декор может быть уложен только на стену.

STONE LOOK

STONE LOOK



Marvel Stone Wall Tiles / Rivestimento

WALL TILES p. 524

MATTE SURFACE / SUPERFICIE MATT

3D WALL TILES / RIVESTIMENTO 3D

± 8,5 mm

50x110 cm 19⁵/₈"x43¹/₄"
AZOV Marvel Clauzetto White 110
AZOW Marvel Desert Beige 110
AZOX Marvel Cardoso Elegant 110

± 11 mm

50x110 cm 19⁵/₈"x43¹/₄"
AZOY Marvel 3D Plot Clauzetto White 110
AZOZ Marvel 3D Plot Desert Beige 110

± 8,5 mm

40x80 cm 15⁵/₄"x31¹/₂"
9MSH Marvel Clauzetto White 40x80
9MSL Marvel Desert Beige 40x80
9MSE Marvel Cardoso Elegant 40x80

± 10 mm

40x80 cm 15⁵/₄"x31¹/₂"
AZOJ Marvel 3D Mesh Clauzetto White 40x80
AZOK Marvel 3D Mesh Desert Beige 40x80

TRIM TILES / PEZZI SPECIALI

LSSU Marvel Clauzetto White Spigolo
0,8x20 cm - 3¹/₈"x7⁷/₈"

AS1C Marvel Clauzetto White Spigolo A.E.
0,8x0,8 cm - 3¹/₈"x3³/₈"

LS1C Marvel Clauzetto White Spigolo 10 mm *
1x20 cm - 3¹/₈"x7⁷/₈"

LSSS Marvel Desert Beige Spigolo
0,8x20 cm - 3¹/₈"x7⁷/₈"

AS1T Marvel Desert Beige Spigolo A.E.
0,8x0,8 cm - 3¹/₈"x3³/₈"

LS1D Marvel Desert Beige Spigolo 10 mm *
1x20 cm - 3¹/₈"x7⁷/₈"

LSSO Marvel Cardoso Elegant Spigolo
0,8x20 cm - 3¹/₈"x7⁷/₈"

AS1O Marvel Cardoso Elegant Spigolo A.E.
0,8x0,8 cm - 3¹/₈"x3³/₈"

DECORATIVE RANGE / GAMMA DECORATIVA

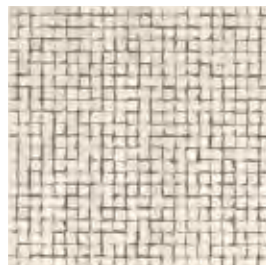

TUMBLED MOSAIC

* THESE PARTS ARE SUPPLIED TO ORDER . I PEZZI SONO DISPONIBILI SU ORDINAZIONE
Les pièces sont disponibles sur commande | Die Teile sind auf Bestellung lieferbar | Las piezas se hacen por encargo | Изготавливаются на заказ



The 10 mm edge matches three-dimensional wall tiles having a 10-11 mm thickness / Lo spigolo 10 mm si abbina a rivestimenti tridimensionali di spessore 10-11 mm / Le bord 10 mm s'adapte aux revêtements tridimensionnels épaisseur 10-11 mm / Die 10 mm Kante ist mit dreidimensionalen Wandfliesen mit einer Dicke von 10-11 mm kombinierbar / La arista de 10 mm se combina con revestimientos tridimensionales de 10 -11 mm de grosor / Угловой элемент 10 мм сочетается с трехмерной настенной плиткой толщиной 10-11 мм.

MATTE SURFACE | SUPERFICIE MATT | Surface Mat | Matt oberfläche | Superficie Mate | Матовая поверхность



CARDOSO ELEGANT



DESERT BEIGE



CLAUZETTO WHITE



3D MESH DESERT BEIGE



3D MESH CLAUZETTO WHITE



3D PLOT DESERT BEIGE



3D PLOT CLAUZETTO WHITE



V2 SLIGHT VARIATION

Clauzetto White,
Desert Beige,
Cardoso Elegant,
3D Mesh Clauzetto White
3D Plot Clauzetto White
3D Mesh Desert Beige
3D Plot Desert Beige



SEASTONE

PORCELAIN TILES

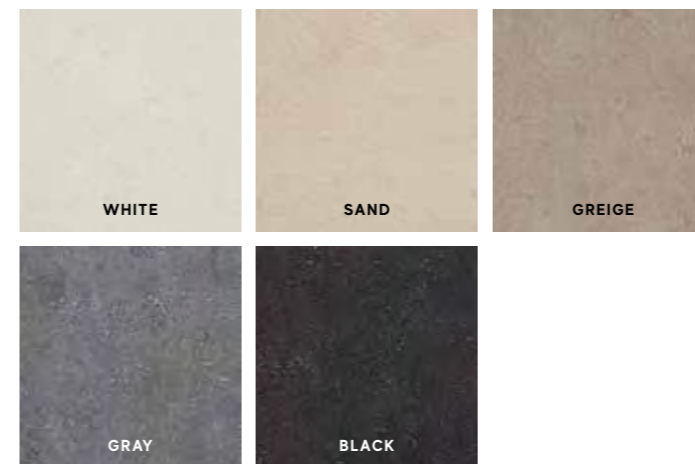

Porcelain Tiles / Gres Porcellanato

COLOURED BODY PORCELAIN TILES - RECTIFIED MONOCALIBER
GRES PORCELLANATO COLORATO IN MASSA - RETTIFICATO MONOCALIBRO

LARGE SIZES p. 366

Sizes	Thickness	Surface finish
60x60 cm - 23 ⁵ / ₈ "x23 ⁵ / ₈ "	± 9 mm	Matte R9 A
30x60 cm - 11 ³ / ₄ "x23 ⁵ / ₈ "	± 9 mm	Matte R9 A

Outdoor Paving and Wet Areas

OUTDOOR PAVING p. 408

Sizes	Thickness	Surface finish
60x60 cm - 23 ⁵ / ₈ "x23 ⁵ / ₈ "	± 20 mm	Textured R11 A+B+C



COLOURED BODY PORCELAIN TILES | GRES PORCELLANATO COLORATO IN MASSA | Grès cérame coloré dans la masse | Durchgefärbtes Feinsteinzeug | Gres porcelánico coloreado en masa | Керамический гранит окрашенный в массе
RECTIFIED MONOCALIBER | RETTIFICATO MONOCALIBRO | Rectifié mono-calibre | Geschliffen einkalibrig | Rectificado monocalibré | Ретифицированный в одном калибре



Seastone Porcelain Tiles / Gres Porcellanato

MATTE SURFACE / SUPERFICIE MATT

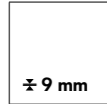

60x60 cm 23⁵/₈"x23⁵/₈"
8S25 Seastone White 60
8S24 Seastone Sand 60
8S23 Seastone Greige 60
8S22 Seastone Gray 60
8S21 Seastone Black 60

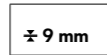

30x60 cm 11³/₄"x23⁵/₈"
D140 Seastone White 30x60
D139 Seastone Sand 30x60
D138 Seastone Greige 30x60
D137 Seastone Gray 30x60
D136 Seastone Black 30x60

Modulo Multiformato

± 9 mm

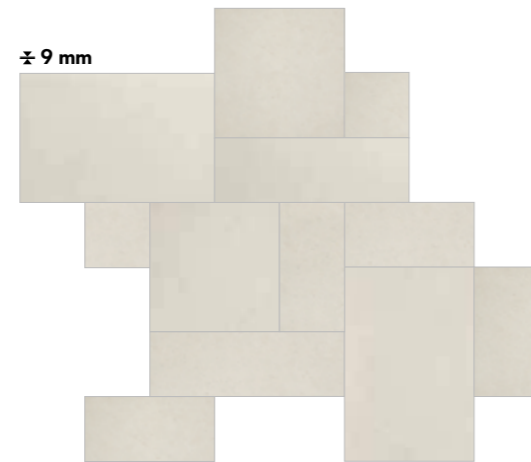

8S4E Seastone White Multiformato ***
8S4D Seastone Sand Multiformato ***
8S47 Seastone Greige Multiformato ***
8S46 Seastone Gray Multiformato ***
8S45 Seastone Black Multiformato ***

1 pcs 40x60 - 15³/₄"x23⁵/₈"
1 pcs 20x60 - 7⁷/₈"x23⁵/₈"
1 pcs 40x40 - 15³/₄"x15³/₄"
2 pcs 20x40 - 7⁷/₈"x15³/₄"
1 pcs 20x20 - 7⁷/₈"x7⁷/₈"

- To be ordered in multiples of 2
Ordinabile in multipli di 2
Peut être commandé en multiples de 2
Zum Bestellen als Vielfache von 2
Es posible efectuar pedidos en múltiplos de 2
Заказываются в количестве кратном 2
- The miniatures of the Multiformato Module are not in proportion.
I minimali nel Modulo Multiformato non sono in proporzione.
Les illustrations à échelle réduite dans le Module Multiformato ne sont pas proportionnelles.
Die Abbildungen im Modul Multiformato sind nicht verhältnismäßig.
Los miniaturas en el Módulo Multiformato no están en proporción.
Изображения Multiformato модуля не соблюдают пропорций.
- Two boxes are needed to create a complete Module. Each box contains:
Per comporre un Modulo intero occorrono due scatole. Ogni scatola contiene:
Deux cartons sont nécessaires pour composer un Module entier. Chaque carton contient:
Für ein vollständiges Modul benötigt man zwei Kartons. Jeder Karton enthält:
Para componer un módulo completo sirven dos cajas. Cada caja contiene:
Для составления одного модуля требуются две коробки. Каждая коробка содержит:

MATTE



WHITE



GREIGE



GREIGE

OUTDOOR PAVING ± 20 mm



SAND



GRAY



GRAY



OUTDOOR PAVING ± 20 mm / PAVIMENTI DA ESTERNO ± 20 mm

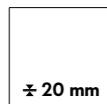

60x60 cm 23⁵/₈"x23⁵/₈"
8S41 Seastone Greige 60 LASTRA 20mm
8S42 Seastone Gray 60 LASTRA 20mm
AV0X Seastone Black 60 LASTRA 20mm



BLACK



BLACK



V2 SLIGHT VARIATION

White,
Sand,
Greige,
Gray,
Black

Seastone Porcelain Tiles / Gres Porcellanato

DECOR RANGE / GAMMA DECORI



8582 Seastone White Mosaico
30x30 - 11³/₄"x11³/₄"

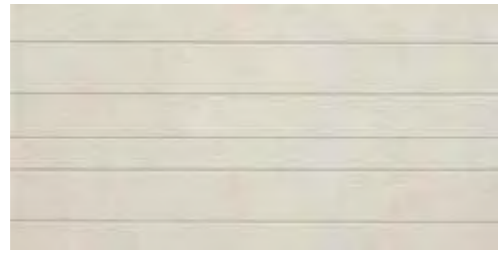

8572 Seastone White Mosaico Linea Mix2
30x60 - 11³/₄"x23⁵/₈"

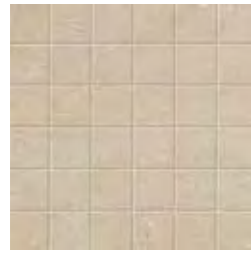

8581 Seastone Sand Mosaico
30x30 - 11³/₄"x11³/₄"



8571 Seastone Sand Mosaico Linea Mix2
30x60 - 11³/₄"x23⁵/₈"



8580 Seastone Greige Mosaico
30x30 - 11³/₄"x11³/₄"



8570 Seastone Greige Mosaico Linea Mix2
30x60 - 11³/₄"x23⁵/₈"



8579 Seastone Gray Mosaico
30x30 - 11³/₄"x11³/₄"



8569 Seastone Gray Mosaico Linea Mix2
30x60 - 11³/₄"x23⁵/₈"



8578 Seastone Black Mosaico
30x30 - 11³/₄"x11³/₄"



8568 Seastone Black Mosaico Linea Mix2
30x60 - 11³/₄"x23⁵/₈"

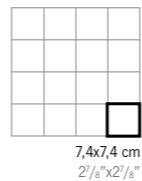
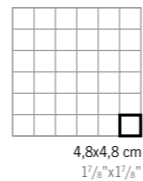

8567 Seastone White Brick 60
30x60 - 11³/₄"x23⁵/₈"



8564 Seastone Gray Brick 60
30x60 - 11³/₄"x23⁵/₈"



8566 Seastone Sand Brick 60
30x60 - 11³/₄"x23⁵/₈"



8563 Seastone Black Brick 60
30x60 - 11³/₄"x23⁵/₈"

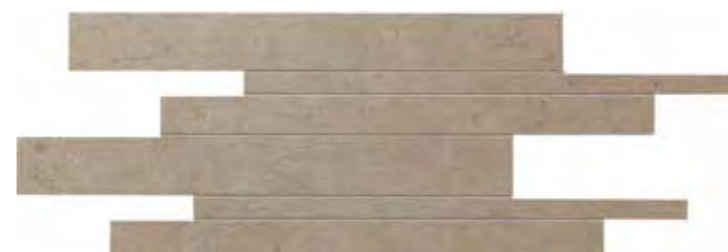

8565 Seastone Greige Brick 60
30x60 - 11³/₄"x23⁵/₈"

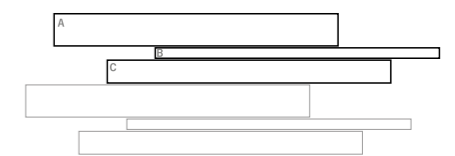





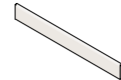
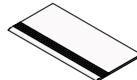
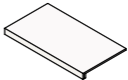
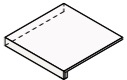

A 4,7x59,5 cm - 1⁷/₈"x11³/₄"
B 2,5x59,5 cm - 1"x23⁵/₈"
C 7,1x59,5 cm - 2⁷/₈"x23⁵/₈"

TRIM TILES / PEZZI SPECIALI

p. 424

UPEC p. 571

						
	Battiscopa 7,2x60 2 ⁷ / ₈ "x23 ⁵ / ₈ "	Gradino * 30x60 11 ³ / ₄ "x23 ⁵ / ₈ "	Scalino * 33x60 13"x23 ⁵ / ₈ "	Scalino Angolare * 33x33 13"x13"	Battiscopa Sag. Scala 7,2x30 - 2 ⁷ / ₈ "x11 ³ / ₄ "	
					DX *	SX *
 White	8587	8592	850I	850Q	ABMR	ABMW
 Sand	8586	8591	850K	850O	ABMQ	ABMV
 Greige	8585	8590	850J	850N	ABMP	ABMU
 Gray	8584	8589	850H	850M	ABMO	ABMT
 Black	8583	8588	850G	850L	ABMN	ABMS

* THESE PARTS ARE SUPPLIED TO ORDER | PEZZI SONO DISPONIBILI SU ORDINAZIONE | Les pièces sont disponibles sur commande | Die Teile sind auf Bestellung lieferbar | Las piezas se hacen por encargo | Изготавливаются на заказ



atlas concorde

TRUST
PORCELAIN TILES

Porcelain Tiles / Gres Porcellanato

COLOURED BODY PORCELAIN TILES - RECTIFIED MONOCALIBER
GRES PORCELLANATO COLORATO IN MASSA - RETTIFICATO MONOCALIBRO



Sizes	Thickness	Surface finish
45x90 cm - 17 ³ / ₄ "x35 ³ / ₈ "	± 9 mm	Matte R10 A+B
22,5x90 cm - 8 ⁷ / ₈ "x35 ³ / ₈ "	± 9 mm	Matte R10 A+B
60x60 cm - 23 ⁵ / ₈ "x23 ⁵ / ₈ "	± 9 mm	Matte R10 A+B
40x60 cm - 15 ³ / ₄ "x23 ⁵ / ₈ "	± 9 mm	Matte R10 A+B
30x60 cm - 11 ³ / ₄ "x23 ⁵ / ₈ "	± 9 mm	Matte R10 A+B
20x60 cm - 7 ⁷ / ₈ "x23 ⁵ / ₈ "	± 9 mm	Matte R10 A+B
30x30 cm - 11 ³ / ₄ "x11 ³ / ₄ "	± 9 mm	Matte R10 A+B

Outdoor Paving and Wet Areas

OUTDOOR PAVING p. 408

Sizes	Thickness	Surface finish
30x60 cm - 11 ³ / ₄ "x23 ⁵ / ₈ "	± 9 mm	Grip R12 A+B+C
120x120 cm - 47 ¹ / ₄ "x47 ¹ / ₄ "	± 20 mm	Textured R11 A+B+C
60x120 cm - 23 ⁵ / ₈ "x47 ¹ / ₄ "	± 20 mm	Textured R11 A+B+C
60x60 cm - 23 ⁵ / ₈ "x23 ⁵ / ₈ "	± 30 mm	Textured R11 A+B+C
60x60 cm - 23 ⁵ / ₈ "x23 ⁵ / ₈ "	± 20 mm	Textured R11 A+B+C
45x90 cm - 17 ³ / ₄ "x35 ³ / ₈ "	± 20 mm	Textured R11 A+B+C
30x60 cm - 11 ³ / ₄ "x23 ⁵ / ₈ "	± 20 mm	Textured R11 A+B+C



COLOURED BODY PORCELAIN TILES | GRES PORCELLANATO COLORATO IN MASSA | Grés céramique coloré dans la masse | Durchgefärbtes Feinsteinzeug | Gres porcelánico coloreado en masa | Керамический гранит окрашенный в массу
RECTIFIED MONOCALIBER | RETTIFICATO MONOCALIBRO | Rectifié mono-calibre | Geschliffen einkalibrig | Rettificado monocalibril | Ретифицированный в одном калибре



Trust Porcelain Tiles / Gres Porcellanato

MATTE SURFACE / SUPERFICIE MATT

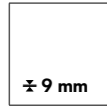

60x60 cm 23⁵/₈"x23⁵/₈"
AA8C Trust Moon 60
AC11 Trust Ivory 60
AC13 Trust Gold 60
AC14 Trust Silver 60
AC15 Trust Copper 60
AC16 Trust Titanium 60

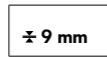

30x60 cm 11³/₄"x23⁵/₈"
D234 Trust Moon 30x60
D156 Trust Ivory 30x60
D157 Trust Gold 30x60
D158 Trust Silver 30x60
D159 Trust Copper 30x60
D160 Trust Titanium 30x60

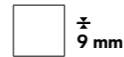

30x30 cm 11³/₄"x11³/₄"
AA8F Trust Moon 30
AC14 Trust Ivory 30
AC15 Trust Gold 30
AC16 Trust Silver 30
AC17 Trust Copper 30
AC18 Trust Titanium 30



45x90 cm 17³/₈"x35³/₈"
AA8A Trust Moon 45x90
AKA6 Trust Ivory 45x90
AKA7 Trust Gold 45x90
AKA8 Trust Silver 45x90
AKA9 Trust Copper 45x90
AKBA Trust Titanium 45x90

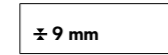

22,5x90 cm 8⁷/₈"x35³/₈"
AA8B Trust Moon 22,5x90
ANBZ Trust Ivory 22,5x90
ANBØ Trust Gold 22,5x90
ANB2 Trust Silver 22,5x90
ANB4 Trust Copper 22,5x90
ANB6 Trust Titanium 22,5x90

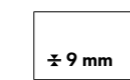

40x60 cm 15³/₄"x23⁵/₈"
AA8D Trust Moon 40x60
ACN1 Trust Ivory 40x60
ACN3 Trust Gold 40x60
ACN4 Trust Silver 40x60
ACN5 Trust Copper 40x60
ACN6 Trust Titanium 40x60

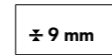

20x60 cm 7⁷/₈"x23⁵/₈"
AA8E Trust Moon 20x60
ACL1 Trust Ivory 20x60
ACL3 Trust Gold 20x60
ACL4 Trust Silver 20x60
ACL5 Trust Copper 20x60
ACL6 Trust Titanium 20x60

GRIP SURFACE / SUPERFICIE GRIP

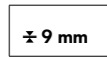

30x60 cm 11³/₄"x23⁵/₈"
D235 Trust Moon 30x60 Grip
D161 Trust Ivory 30x60 Grip
D162 Trust Gold 30x60 Grip
D163 Trust Silver 30x60 Grip
D164 Trust Copper 30x60 Grip
D165 Trust Titanium 30x60 Grip

OUTDOOR PAVING ± 20-30 mm / PAVIMENTI DA ESTERNO ± 20-30 mm

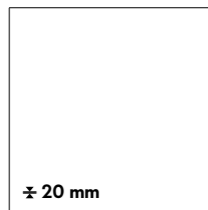

120x120 cm 47¹/₄"x47¹/₄"
AOYB Trust Gold 120x120 LASTRA 20mm
AOYC Trust Silver 120x120 LASTRA 20mm



60x120 cm 23⁵/₈"x47¹/₄"
AY4E Trust Gold 60x120 LASTRA 20 mm
AY4D Trust Silver 60x120 LASTRA 20 mm
AY4F Trust Titanium 60x120 LASTRA 20 mm
AY4G Trust Ivory 60x120 LASTRA 20 mm

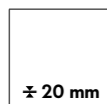

60x60 cm 23⁵/₈"x23⁵/₈"
ABLI Trust Gold LASTRA 20 mm
ABLJ Trust Silver LASTRA 20 mm
ABLK Trust Titanium LASTRA 20 mm
AY4B Trust Ivory LASTRA 20 mm

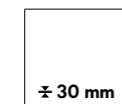

60x60 cm 23⁵/₈"x23⁵/₈"
AL7G Trust Gold LASTRA 30 mm
AL7H Trust Silver LASTRA 30 mm
AL7I Trust Titanium LASTRA 30 mm

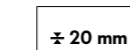

30x60 cm 11³/₄"x23⁵/₈"
ATZZ Trust Gold 30x60 LASTRA 20 mm
ACEI Trust Silver 30x60 LASTRA 20 mm
ATZØ Trust Titanium 30x60 LASTRA 20 mm
ATZY Trust Ivory 30x60 LASTRA 20 mm

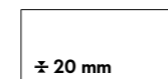

45x90 cm 17³/₈"x35³/₈"
ACHH Trust Gold 45x90 LASTRA 20 mm
ACHG Trust Silver 45x90 LASTRA 20 mm
ACHJ Trust Titanium 45x90 LASTRA 20 mm
AY4C Trust Ivory 45x90 LASTRA 20 mm

MATTE SURFACE | SUPERFICIE MATT | Surface Mat | Matt oberfläche | Superficie Mate | Матовая поверхность
GRIP SURFACE | SUPERFICIE GRIP | Surface grip | Grip oberfläche | Superficie Grip | Grip поверхность
OUTDOOR PAVING | PAVIMENTI DA ESTERNO | Sols d'extérieur | Bodenbeläge für Außenbereiche | Pavimentos para exteriores | Уличная плитка

MATTE / GRIP



MOON



IVORY



GOLD

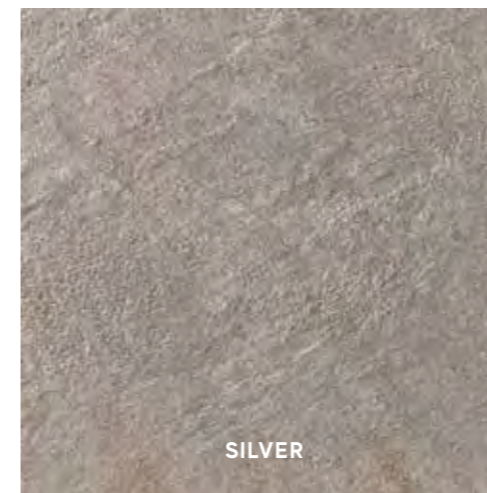

SILVER



COPPER



TITANIUM

OUTDOOR PAVING ± 20 mm



SILVER



IVORY



GOLD



V3 MODERATE VARIATION

Ivory, Gold, Silver, Copper, Titanium



V2 SLIGHT VARIATION

Moon

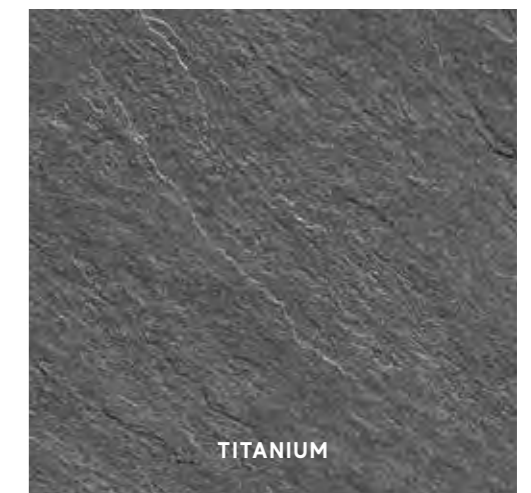

TITANIUM

Trust Porcelain Tiles / Gres Porcellanato

DECOR RANGE / GAMMA DECORI



ABDW Trust Moon Mosaico
30x30 - 11³/₄"x11³/₄"



ACLA Trust Ivory Mosaico
30x30 - 11³/₄"x11³/₄"



ACLC Trust Gold Mosaico
30x30 - 11³/₄"x11³/₄"



ACLD Trust Silver Mosaico
30x30 - 11³/₄"x11³/₄"



ACLE Trust Copper Mosaico
30x30 - 11³/₄"x11³/₄"



ACLF Trust Titanium Mosaico
30x30 - 11³/₄"x11³/₄"



ABDX Trust Moon Brick
30x60 - 11³/₄"x23⁵/₈"



ACNA Trust Ivory Brick
30x60 - 11³/₄"x23⁵/₈"



ACNB Trust Gold Brick
30x60 - 11³/₄"x23⁵/₈"



ACNC Trust Silver Brick
30x60 - 11³/₄"x23⁵/₈"

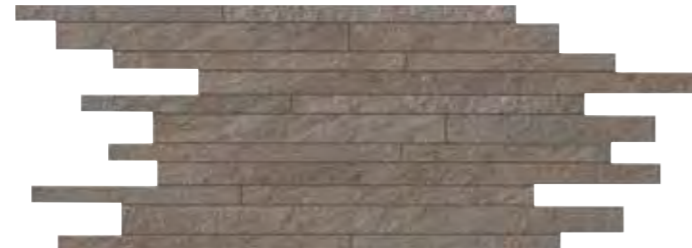

ACND Trust Copper Brick
30x60 - 11³/₄"x23⁵/₈"



ACNE Trust Titanium Brick
30x60 - 11³/₄"x23⁵/₈"

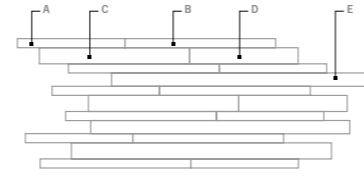

A 2,1x24,8 cm - 7/4"x9 1/4"
B 2,1x34,5 cm - 7/4"x13 3/4"
C 3,3x34,5 cm - 1 1/4"x13 3/4"
D 3,3x24,8 cm - 1 1/4"x9 1/4"
E 2,5x60 cm - 1"x23 5/8"

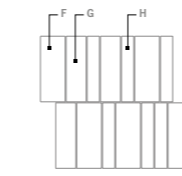

F 5,6x14,7 cm - 2 1/4"x5 7/4"
G 4,5x14,7 cm - 1 1/4"x5 7/4"
H 2,8x14,7 cm - 1 1/8"x5 7/4"

TRIM TILES / PEZZI SPECIALI

p. 424

LUPEC p. 571

	Battiscopa 7,5x30 3"x11 ³ / ₄ "	Gradino * 30x30 11 ³ / ₄ "x11 ³ / ₄ "	Scalino * 33x60 13"x23 ⁵ / ₈ "	Scalino Angolare * 33x33 13"x13"	Battiscopa Sag. Scala 7,5x30 - 3"x11 ³ / ₄ "		Elemento L * 15x30 5 7/8"x11 ³ / ₄ "	Elemento L Grip * 15x60 H. 4 5 7/8"x23 ⁵ / ₈ " H. 1 5/8"
					DX *	SX *		
Moon	AAHW	AAHX	AAHY	AAHZ	AAHØ	AAH1	AAH5	AORD
Ivory	AD94	AD89	ACYU	ACYZ	AEAL	AEAM	ABØ8	AORA
Gold	AD95	AD9Ø	ACYV	ACYØ	AEAN	AEAO	AB1A	AWRB
Silver	AD96	AD91	ACYW	ACY1	AEAP	AEAQ	AB1B	AD3M
Copper	AD97	AD92	ACYX	ACY2	AEAR	AEAT	AB1C	AORB
Titanium	AD98	AD93	ACYY	ACY3	AEAU	AEAV	AB1D	AORC

* THESE PARTS ARE SUPPLIED TO ORDER | I PEZZI SONO DISPONIBILI SU ORDINAZIONE | Les pièces sont disponibles sur commande | Die Teile sind auf Bestellung lieferbar | Las piezas se hacen por encargo | Изготавливаются на заказ



STONE LOOK

STONE LOOK

atlas concorde

Arbor

PORCELAIN&WALL TILES

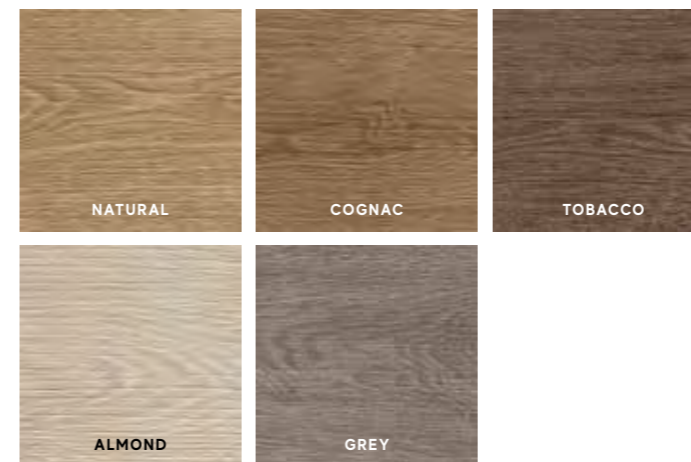

Porcelain Tiles / Gres Porcellanato

COLOURED BODY PORCELAIN TILES - RECTIFIED MONOCALIBER
GRES PORCELLANATO COLORATO IN MASSA - RETTIFICATO MONOCALIBRO

Sizes	Thickness	Surface finish
30x240 cm - 11 ³ / ₄ "x94 ¹ / ₂ "	± 9 mm	Matte R10 A
18,5x150 cm - 7 ¹ / ₄ "x59"	± 9 mm	Matte R10 A+B
15x90 cm - 5 ⁷ / ₈ "x35 ³ / ₈ "	± 9 mm	Matte R10 A+B
7,5x60 cm - 3"x23 ⁵ / ₈ "	± 8,5 mm	Matte R10 A

Outdoor Paving and Wet Areas

OUTDOOR PAVING p. 408

Sizes	Thickness	Surface finish
15x90 cm - 5 ⁷ / ₈ "x35 ³ / ₈ "	± 9 mm	Grip R11 A+B+C

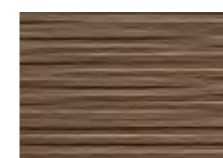

3D WOODEN TOBACCO

Wall Tiles / Rivestimento

WHITEBODY WALL TILES - RECTIFIED MONOCALIBER
RIVESTIMENTI IN PASTA BIANCA - RETTIFICATO MONOCALIBRO

3D Wall Tiles

Sizes	Thickness	Surface finish
40x80 cm - 15 ³ / ₄ "x31 ¹ / ₂ "	± 10 mm	Matte



COLOURED BODY PORCELAIN TILES | GRES PORCELLANATO COLORATO IN MASSA | Grés cérame coloré dans la masse | Durchgefärbtes Feinsteinzeug | Gres porcelánico coloreado en masa | Керамический гранит окрашенный в массе
WHITEBODY WALL TILES | RIVESTIMENTI IN PASTA BIANCA | Revêtements en pâte blanche | Weißscherbige Wandfliesen | Revestimientos en pasta blanca | Настенная плитка из белой глины
RECTIFIED MONOCALIBER | RETTIFICATO MONOCALIBRO | Rectifié mono-calibre | Geschliffen einkalibrig | Rectificado monocalibre | Ретифицированный в одном калибре
NON RECTIFIED | NON RETTIFICATO | Non rectifié | Nicht rektifiziert | No rectificada | Неретифицированные



Arbor Porcelain Tiles / Gres Porcellanato

MATTE SURFACE / SUPERFICIE MATT

± 9 mm

30x240 cm 11 3/4" x 94 1/2"

AMHU Arbor Natural 30x240
AMHV Arbor Cognac 30x240
AMHX Arbor Tobacco 30x240

TOBACCO



COGNAC



NATURAL



± 9 mm

18,5x150 cm 7 1/4" x 59"

AMFH Arbor Almond 18,5x150
AMFK Arbor Grey 18,5x150
AMFI Arbor Natural 18,5x150
AMFJ Arbor Cognac 18,5x150
AMFL Arbor Tobacco 18,5x150

TOBACCO



COGNAC



NATURAL



GREY



ALMOND



WOOD LOOK



**V3
MODERATE
VARIATION**
Tobacco,
Cognac,
Natural



**V3
MODERATE
VARIATION**
Tobacco,
Cognac,
Natural,
Almond,
Grey



Arbor Porcelain Tiles / Gres Porcellanato

MATTE SURFACE / SUPERFICIE MATT

± 9 mm

15x90 cm 5⁷/₈"x35³/₈"
AMFM Arbor Almond 15x90
AMFQ Arbor Grey 15x90
AMFN Arbor Natural 15x90
AMFO Arbor Cognac 15x90
AMFR Arbor Tobacco 15x90



Arbor Porcelain Tiles / Gres Porcellanato

GRIP SURFACE / SUPERFICIE GRIP

± 9 mm

15x90 cm 5⁷/₈"x35³/₈"
AMFS Arbor Almond 15x90 Grip
AMFV Arbor Grey 15x90 Grip
AMFT Arbor Natural 15x90 Grip
AMFU Arbor Cognac 15x90 Grip
AMFW Arbor Tobacco 15x90 Grip



WOOD LOOK

WOOD LOOK



NON RECTIFIED / NON RETTIFICATO

± 8,5 mm

7,5x60 cm 3"x23⁵/₈"
AN32 Arbor Natural 7,5x60
AN33 Arbor Cognac 7,5x60
AN34 Arbor Tobacco 7,5x60

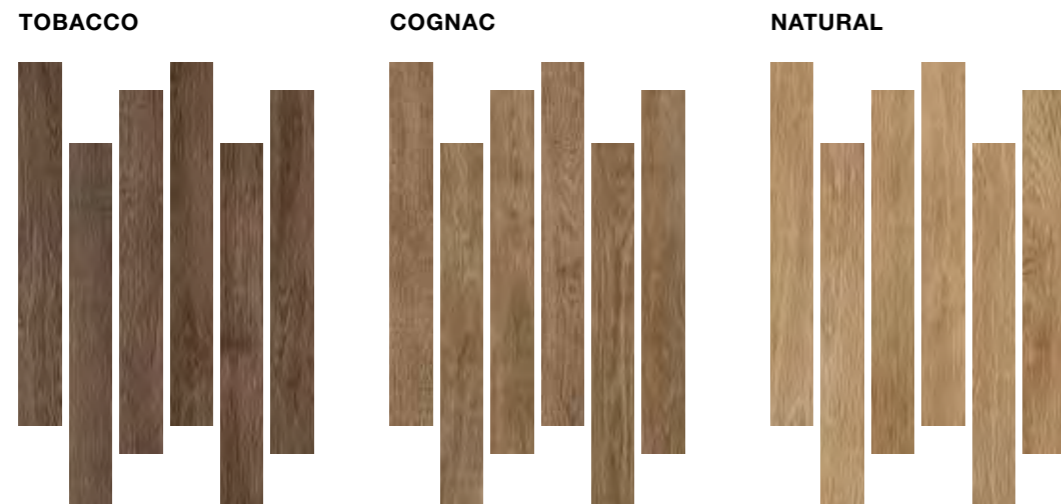

V3 MODERATE VARIATION

Tobacco,
Cognac,
Natural,
Almond,
Grey

MATTE SURFACE | SUPERFICIE MATT | Surface Mat | Matt oberfläche | Superficie Mate | Матовая поверхность
NON RECTIFIED | NON RETTIFICATO | Non rectifié | Nicht rektifiziert | No rectificada | Неретицированные

DECOR RANGE / GAMMA DECORI



2,3x90 cm
7¹/₈"x35³/₈"



V3 MODERATE VARIATION

Tobacco,
Cognac,
Natural,
Almond,
Grey

GRIP SURFACE | SUPERFICIE GRIP | Surface grip | Grip oberfläche | Superficie Grip | Grip поверхность

Arbor Porcelain Tiles / Gres Porcellanato

DECOR RANGE / GAMMA DECORI



AN4E Arbor Tobacco Herringbone
36,2x41,2 - 14¹/₈"x16¹/₈"



AN4C Arbor Cognac Herringbone
36,2x41,2 - 14¹/₈"x16¹/₈"



AN4B Arbor Natural Herringbone
36,2x41,2 - 14¹/₈"x16¹/₈"



AN4D Arbor Grey Herringbone
36,2x41,2 - 14¹/₈"x16¹/₈"



AN4A Arbor Almond Herringbone
36,2x41,2 - 14¹/₈"x16¹/₈"

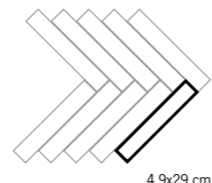

4,9x29 cm
1⁷/₈"x11³/₈"



Arbor 3D Wall Tiles / Rivestimento 3D

MATTE SURFACE / SUPERFICIE MATT



8AWT 3D Wooden Tobacco 40x80
40x80 cm - 15³/₄"x31¹/₂"

TRIM TILES / PEZZI SPECIALI

p. 424

UPEC p. 571

	 Battiscopa Digitale 7,2x90 2 ⁷ / ₈ "x35 ³ / ₈ "	 Scalino * 33x150 13"x59"	 Scalino Angolare 33x33 - 13"x13"		 Battiscopa Digitale Sag. Scala 7,2x30 - 2 ⁷ / ₈ "x11 ³ / ₄ "	
			DX *	SX *	DX *	SX *
Almond	ANWM	ANWR	ANW1	ANWW	ANXB	ANW6
Natural	ANWN	ANWS	ANW2	ANWX	ANXC	ANW7
Cognac	ANWO	ANWT	ANW3	ANWY	ANXD	ANW8
Grey	ANWP	ANWU	ANW4	ANWZ	ANXE	ANW9
Tobacco	ANWQ	ANWV	ANW5	ANWØ	ANXF	ANXA

* THESE PARTS ARE SUPPLIED TO ORDER | I PEZZI SONO DISPONIBILI SU ORDINAZIONE | Les pièces sont disponibles sur commande | Die Teile sind auf Bestellung lieferbar | Las piezas se hacen por encargo | Изготавливаются на заказ



V2
SLIGHT
VARIATION

3D Wooden Tobacco



MATTE SURFACE | SUPERFICIE MATT | Surface Mat | Matt oberfläche | Superficie Mate | Матовая поверхность



atlas concorde

AXI

PORCELAIN TILES

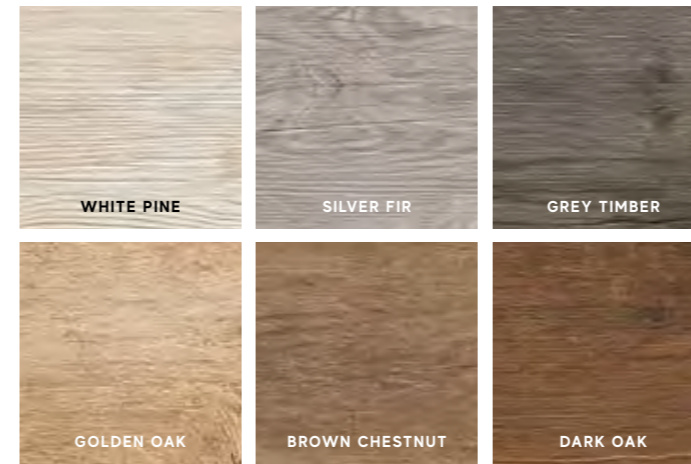

Porcelain Tiles / Gres Porcellanato

COLOURED BODY PORCELAIN TILES - RECTIFIED MONOCALIBER
GRES PORCELLANATO COLORATO IN MASSA - RETTIFICATO MONOCALIBRO

Sizes	Thickness	Surface finish
22,5x90 cm - 8 ⁷ / ₈ "x35 ³ / ₈ "	± 9,5 mm	Matte R10 A+B
15x90 cm - 5 ⁷ / ₈ "x35 ³ / ₈ "	± 9,5 mm	Matte R10 A+B

Outdoor Paving and Wet Areas

OUTDOOR PAVING p. 408

Sizes	Thickness	Surface finish
22,5x90 cm - 8 ⁷ / ₈ "x35 ³ / ₈ "	± 9,5 mm	Textured R11 A+B+C
40x120 cm - 15 ³ / ₄ "x47 ¹ / ₄ "	± 20 mm	Textured R11 A+B+C
60x60 cm - 23 ⁵ / ₈ "x23 ⁵ / ₈ "	± 20 mm	Textured R11 A+B+C
45x90 cm - 17 ³ / ₄ "x35 ³ / ₈ "	± 20 mm	Textured R11 A+B+C



atlas concorde

COLOURED BODY PORCELAIN TILES | GRES PORCELLANATO COLORATO IN MASSA | Grés cérame coloré dans la masse | Durchgefärbtes Feinsteinzeug | Gres porcelánico coloreado en masa | Керамический гранит окрашенный в массу
RECTIFIED MONOCALIBER | RETTIFICATO MONOCALIBRO | Rectifié mono-calibre | Geschliffen einkalbrig | Rectificado monocalibré | Ретифицированный в одном калибре



Axi Porcelain Tiles / Gres Porcellanato

MATTE SURFACE / SUPERFICIE MATT

± 9,5 mm

22,5x90 cm 8^{7/8}"x35^{3/8}"
AS3B Axi White Pine 22,5x90 R10
AS3D Axi Silver Fir 22,5x90 R10
AS3E Axi Grey Timber 22,5x90 R10
AS3C Axi Golden Oak 22,5x90 R10
AS3A Axi Brown Chestnut 22,5x90 R10
AS3F Axi Dark Oak 22,5x90 R10

± 9,5 mm

15x90 cm 5^{7/8}"x35^{3/8}"
AS3G Axi White Pine 15x90 R10
AS3I Axi Silver Fir 15x90 R10
AS3J Axi Grey Timber 15x90 R10
AS3H Axi Golden Oak 15x90 R10
AS3K Axi Brown Chestnut 15x90 R10
AS3L Axi Dark Oak 15x90 R10

WHITE PINE



SILVER FIR



GREY TIMBER



GOLDEN OAK



BROWN CHESTNUT



DARK OAK



V2 SLIGHT VARIATION

White Pine,
Silver Fir,
Grey Timber,
Dark Oak



V3 MODERATE VARIATION

Golden Oak,
Brown Chestnut

MATTE SURFACE | SUPERFICIE MATT | Surface Mat | Matt oberfläche | Superficie Mate | Матовая поверхность
TEXTURED SURFACE | SUPERFICIE STRUTTURATA | Surface structuré | Strukturiert oberfläche | Superficie estructurado | Структурная поверхность



Axi Porcelain Tiles / Gres Porcellanato

TEXTURED SURFACE / SUPERFICIE STRUTTURATA

± 9,5 mm

22,5x90 cm 8^{7/8}"x35^{3/8}"
AE7O Axi White Pine Strutturato
AE7Q Axi Silver Fir Strutturato
AE7R Axi Grey Timber Strutturato
AE7P Axi Golden Oak Strutturato
AE7S Axi Brown Chestnut Strutturato
AE7T Axi Dark Oak Strutturato

WHITE PINE



SILVER FIR



GREY TIMBER



GOLDEN OAK



BROWN CHESTNUT



DARK OAK



OUTDOOR PAVING ± 20 mm / PAVIMENTI DA ESTERNO ± 20 mm

± 20 mm

60x60 cm 23^{3/8}"x23^{3/8}"
AE7G Axi Grey Timber 60 LASTRA 20mm
AE7H Axi Brown Chestnut 60 LASTRA 20mm

± 20 mm

45x90 cm 17^{3/8}"x35^{3/8}"
ADU5 Axi White Pine 45x90 LASTRA 20mm
ADU7 Axi Grey Timber 45x90 LASTRA 20mm
ADU6 Axi Golden Oak 45x90 LASTRA 20mm
ADU8 Axi Brown Chestnut 45x90 LASTRA 20mm

± 20 mm

40x120 cm 15^{3/4}"x47^{1/4}"
AMNC Axi Grey Timber 40x120 LASTRA 20mm
AMND Axi Brown Chestnut 40x120 LASTRA 20mm

GREY TIMBER

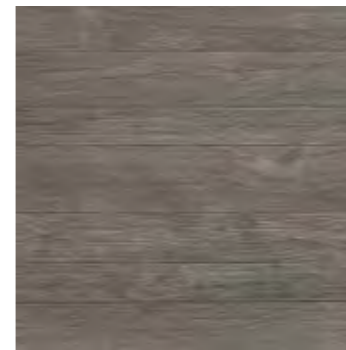

BROWN CHESTNUT

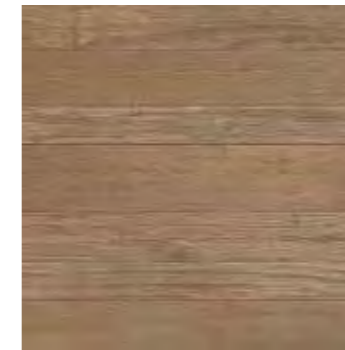

GREY TIMBER



BROWN CHESTNUT

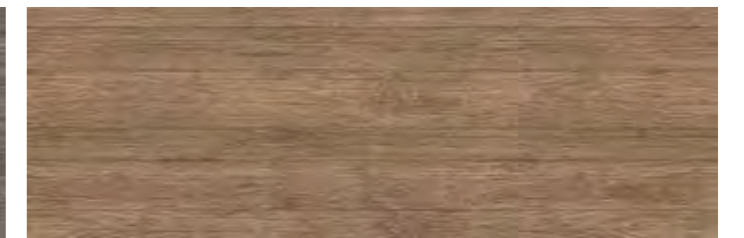

V2 SLIGHT VARIATION

White Pine,
Silver Fir,
Grey Timber,
Dark Oak



V3 MODERATE VARIATION

Golden Oak,
Brown Chestnut

TEXTURED SURFACE | SUPERFICIE STRUTTURATA | Surface structuré | Strukturiert oberfläche | Superficie estructurado | Структурная поверхность
OUTDOOR PAVING | PAVIMENTI DA ESTERNO | Sols d'extérieur | Bodenbeläge für Außenbereiche | Pavimentos para exteriores | Уличная плитка

WOOD LOOK

Axi Porcelain Tiles / Gres Porcellanato

DECOR RANGE / GAMMA DECORI



AMWG Axi White Pine
Tatami
22,5x90 - 8 7/8" x 35 3/8"



AMWI Axi Silver Fir
Tatami
22,5x90 - 8 7/8" x 35 3/8"



AMWJ Axi Grey Timber
Tatami
22,5x90 - 8 7/8" x 35 3/8"



AMWH Axi Golden Oak
Tatami
22,5x90 - 8 7/8" x 35 3/8"



AMWK Axi Brown Chestnut
Tatami
22,5x90 - 8 7/8" x 35 3/8"



AMWL Axi Dark Oak
Tatami
22,5x90 - 8 7/8" x 35 3/8"



AMV7 Axi White Pine Mosaico 3D *
35x35 - 13 3/4" x 13 3/4"



AMV1 Axi Silver Fir Mosaico 3D *
35x35 - 13 3/4" x 13 3/4"

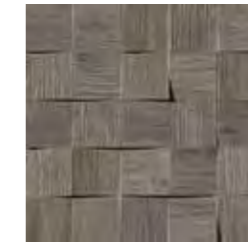

AMV4 Axi Grey Timber Mosaico 3D *
35x35 - 13 3/4" x 13 3/4"



AMVØ Axi Golden Oak Mosaico 3D *
35x35 - 13 3/4" x 13 3/4"



AMV8 Axi Brown Chestnut Mosaico 3D *
35x35 - 13 3/4" x 13 3/4"

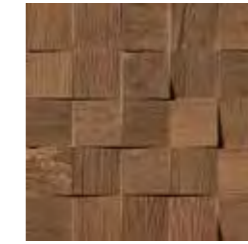

AMV9 Axi Dark Oak Mosaico 3D *
35x35 - 13 3/4" x 13 3/4"



AMWM Axi White Pine
Treccia
28x53 - 11" x 20 7/8"



AMWO Axi Silver Fir
Treccia
28x53 - 11" x 20 7/8"



AMWP Axi Grey Timber
Treccia
28x53 - 11" x 20 7/8"



AMWN Axi Golden Oak
Treccia
28x53 - 11" x 20 7/8"



AMWQ Axi Brown Chestnut
Treccia
28x53 - 11" x 20 7/8"



AMWR Axi Dark Oak
Treccia
28x53 - 11" x 20 7/8"



ANIO Axi Bottone Decorato Mix 4
7,5x7,5 - 3" x 3"



AMWA White Pine
Brick 3D *
20x44 - 7 7/8" x 17 3/8"



AMWC Axi Silver Fir
Brick 3D *
20x44 - 7 7/8" x 17 3/8"



AMWD Axi Grey Timber
Brick 3D *
20x44 - 7 7/8" x 17 3/8"



AMWB Axi Golden Oak
Brick 3D *
20x44 - 7 7/8" x 17 3/8"



AMWE Axi Brown Chestnut
Brick 3D *
20x44 - 7 7/8" x 17 3/8"



AMWF Axi Dark Oak
Brick 3D *
20x44 - 7 7/8" x 17 3/8"

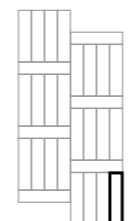

3,3x14 cm
1 1/4" x 5 1/2"

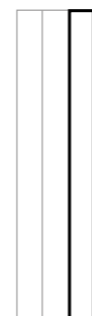

7,2x89,5 cm
2 7/8" x 35 1/4"

*** MULTI-THICKNESS MOSAIC, CLOSE JOINT INSTALLATION WITHOUT GROUTING.**

MOSAICO MULTISPESORE, POSA SENZA STUCCATURA A GIUNTO UNITO.
Mosaïque multi-épaisseur, pose sans mortier avec joint nul.
Mosaik mit verschieden Stärken, fugenlose Verlegung ohne Mörtel.
Mosaico multiespesor, colocación sin mástique y sin juntas.
Мозаика разной толщины; укладка встык без затирки швов.

THE DECORATION CAN ONLY BE LAID ON THE WALL | IL DECORO SI PUÒ POSARE SOLO A RIVESTIMENTO
Décor uniquement mural | Das Dekor kann nur an der Wand verlegt werden | La decoración se puede colocar únicamente en paredes | Декор может быть уложен только на стену.

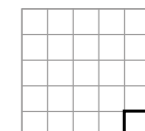

6,9x6,9 cm
2 3/4" x 2 3/4"

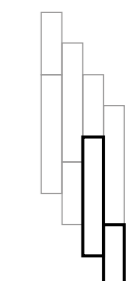

5x29 cm - 2" x 11 3/8"
5x15 cm - 2" x 5 7/8"

Axi Porcelain Tiles / Gres Porcellanato

DECOR RANGE / GAMMA DECORI



ANIT Axi Brown Chestnut Rosone Mini ♦
45x45 - 17³/₈"x17³/₈"



Layout 1



Layout 2

♦ TO BE ORDERED IN MULTIPLES OF 4. ORDINABILE IN MULTIPLI DI 4
Peut être commandé en multiples de 4. Zum Bestellen als Vielfache von 4. Es posible efectuar pedidos en múltiplos de 4. Заказываются в количестве кратном 4.



ANIQ Axi Angolo Elegance ♦
90x90 - 35³/₈"x35³/₈"



ANIS Axi Fascia Elegance ♦
90x90 - 35³/₈"x35³/₈"

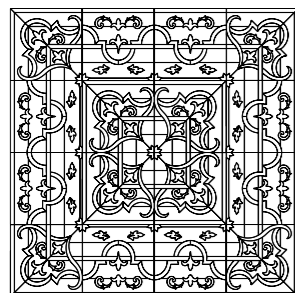

Layout 1
360x360 - 141³/₄"x141³/₄"

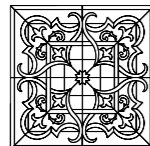

Layout 2
180x180 - 70⁷/₈"x70⁷/₈"

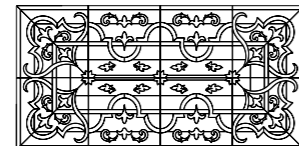

Layout 3
180x360 - 70⁷/₈"x141³/₄"

TRIM TILES / PEZZI SPECIALI

p. 424

UPEC p. 571

	Battiscopa 7,2x90 2 ⁷ / ₈ "x35 ³ / ₈ "	Scalino ♦ 22,5x90 8 ⁷ / ₈ "x35 ³ / ₈ "	Scalino Angolare 22,5x22,5 - 8 ⁷ / ₈ "x8 ⁷ / ₈ "		Battiscopa Sag. Scala 7,2x30 - 2 ⁷ / ₈ "x11 ³ / ₄ "		Elemento L Strutturato ♦ 22,5x90 H. 4 8 ⁷ / ₈ "x35 ³ / ₈ " H. 1 ¹ / ₈ "
			DX ♦	SX ♦	DX ♦	SX ♦	
White Pine	ANLH	ANLO	ANLV	ANL1	ANMA	ANMG	ANMM
Silver Fir	ANLK	ANLQ	ANLX	ANL2	ANMC	ANML	ANMO
Golden Oak	ANLJ	ANLP	ANLW	ANL5	ANMB	ANMJ	ANMN
Brown Chestnut	ANLM	ANLT	ANLZ	ANL9	ANME	ANMH	ANMQ
Dark Oak	ANLN	ANLU	ANLØ	ANL7	ANMF	ANMI	ANMR
Grey Timber	ANLL	ANLR	ANLY	ANL4	ANMD	ANMK	ANMP

♦ THESE PARTS ARE SUPPLIED TO ORDER | I PEZZI SONO DISPONIBILI SU ORDINAZIONE | Les pièces sont disponibles sur commande | Die Teile sind auf Bestellung lieferbar | Las piezas se hacen por encargo | Изготавливаются на заказ



WOOD LOOK

WOOD LOOK



atlas concorde

ETIC

PORCELAIN TILES

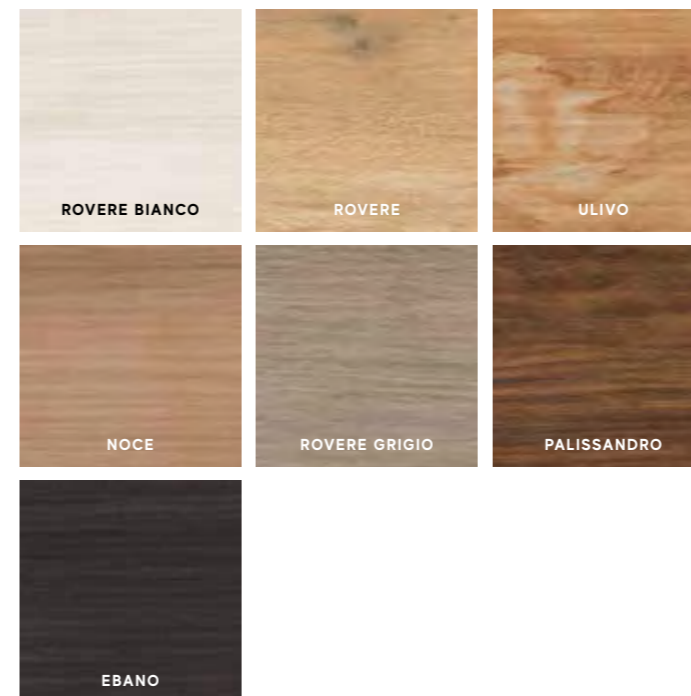

Porcelain Tiles / Gres Porcellanato

COLOURED BODY PORCELAIN TILES - RECTIFIED MONOCALIBER
GRES PORCELLANATO COLORATO IN MASSA - RETTIFICATO MONOCALIBRO

Sizes	Thickness	Surface finish
22,5x90 cm - 8 ⁷ / ₈ "x35 ³ / ₈ "	± 9,5 mm	Matte R9 A
15x90 cm - 5 ⁷ / ₈ "x35 ³ / ₈ "	± 9,5 mm	Matte R9 A
11x90 cm - 4 ³ / ₈ "x35 ³ / ₈ "	± 9 mm	Matte R9 A

Outdoor Paving and Wet Areas

OUTDOOR PAVING p. 408

Sizes	Thickness	Surface finish
22,5x90 cm - 8 ⁷ / ₈ "x35 ³ / ₈ "	± 9,5 mm	Textured R11 A+B+C



atlas concorde

COLOURED BODY PORCELAIN TILES | GRES PORCELLANATO COLORATO IN MASSA | Grés céramé coloré dans la masse | Durchgefärbtes Feinsteinzeug | Gres porcelánico coloreado en masa | Керамический гранит окрашенный в массу
RECTIFIED MONOCALIBER | RETTIFICATO MONOCALIBRO | Rectifié mono-calibre | Geschliffen einkalibrig | Rettificado monocalibre | Ретифицированный в одном калибре



Etic Porcelain Tiles / Gres Porcellanato

MATTE SURFACE / SUPERFICIE MATT

± 9,5 mm

22,5x90 cm 8⁷/₈"x35³/₈"
 AJ8D Etic Rovere 22,5x90
 AJ8E Etic Ulivo 22,5x90
 AJ8F Etic Noce 22,5x90
 AJ8G Etic Palissandro 22,5x90
 AJ78 Etic Rovere Bianco 22,5x90
 AJ8H Etic Rovere Grigio 22,5x90
 AJ8I Etic Ebano 22,5x90

± 9,5 mm

15x90 cm 5⁷/₈"x35³/₈"
 AJ8P Etic Rovere 15x90
 AJ8O Etic Ulivo 15x90
 AJ8N Etic Noce 15x90
 AJ8Q Etic Palissandro 15x90
 AJ68 Etic Rovere Bianco 15x90
 AJ69 Etic Rovere Grigio 15x90
 AJ7A Etic Ebano 15x90

± 9 mm

11x90 cm 4³/₈"x35³/₈"
 AJ8J Etic Rovere 11x90
 AJ8M Etic Ulivo 11x90
 AJ8K Etic Noce 11x90
 AJ8L Etic Palissandro 11x90
 AJ65 Etic Rovere Bianco 11x90
 AJ66 Etic Rovere Grigio 11x90
 AJ67 Etic Ebano 11x90

ROVERE



ULIVO



NOCE



PALISSANDRO



ROVERE BIANCO



ROVERE GRIGIO



EBANO



V2 SLIGHT VARIATION
 Rovere Bianco, Ebano



V3 MODERATE VARIATION
 Rovere, Rovere Grigio, Ulivo, Noce, Palissandro

MATTE SURFACE | SUPERFICIE MATT | Surface Mat | Matt oberfläche | Superficie Mate | Матовая поверхность

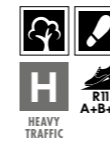

Etic Porcelain Tiles / Gres Porcellanato

TEXTURED SURFACE / SUPERFICIE STRUTTURATA

± 9,5 mm

22,5x90 cm 8⁷/₈"x35³/₈"
 AJ8Y Etic Rovere 22,5x90 Strutturato
 AJ8Z Etic Ulivo 22,5x90 Strutturato
 AJ8U Etic Noce 22,5x90 Strutturato
 AJ8Q Etic Palissandro 22,5x90 Strutturato
 AJ8R Etic Rovere Bianco 22,5x90 Strutturato
 AJ8S Etic Rovere Grigio 22,5x90 Strutturato
 AJ8T Etic Ebano 22,5x90 Strutturato

ROVERE



ULIVO



NOCE



PALISSANDRO



ROVERE BIANCO



ROVERE GRIGIO



EBANO



V2 SLIGHT VARIATION
 Rovere Bianco, Ebano



V3 MODERATE VARIATION
 Rovere, Rovere Grigio, Ulivo, Noce, Palissandro

TEXTURED SURFACE | SUPERFICIE STRUTTURATA | Surface structuré | Strukturiert oberfläche | Superficie estructurado | Структурная поверхность

WOOD LOOK

Etic Porcelain Tiles / Gres Porcellanato

DECOR RANGE / GAMMA DECORI



AM8D Etic Rovere
Tatami 22,5x90
22,5x90 - 8⁷/₈"x35³/₈"



AM8E Etic Ulivo
Tatami 22,5x90
22,5x90 - 8⁷/₈"x35³/₈"



AM8F Etic Noce
Tatami 22,5x90
22,5x90 - 8⁷/₈"x35³/₈"



AM8H Etic Palissandro
Tatami 22,5x90
22,5x90 - 8⁷/₈"x35³/₈"



AM8C Etic Rovere Bianco
Tatami 22,5x90
22,5x90 - 8⁷/₈"x35³/₈"



AM8G Etic Rovere Grigio
Tatami 22,5x90
22,5x90 - 8⁷/₈"x35³/₈"



AM8I Etic Ebano
Tatami 22,5x90
22,5x90 - 8⁷/₈"x35³/₈"



2,3x90 cm
7/8"x35 3/8"



AM8K Etic Rovere Cassettone 45
45x45 - 17³/₄"x17³/₄"



AM8L Etic Ulivo Cassettone 45
45x45 - 17³/₄"x17³/₄"



AM8M Etic Noce Cassettone 45
45x45 - 17³/₄"x17³/₄"



AM8O Etic Palissandro Cassettone 45
45x45 - 17³/₄"x17³/₄"



AM8J Etic Rovere Bianco Cassettone 45
45x45 - 17³/₄"x17³/₄"



AM8N Etic Rovere Grigio Cassettone 45
45x45 - 17³/₄"x17³/₄"



AM8P Etic Ebano Cassettone 45
45x45 - 17³/₄"x17³/₄"

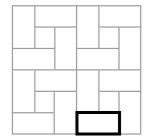

14,5x7,4 cm
5 7/8"x2 1/8"



AM8R Etic Rovere
Bottone 7x7
7x7 - 2³/₄"x2³/₄"



AM8T Etic Noce
Bottone 7x7
7x7 - 2³/₄"x2³/₄"



AM8V Etic Palissandro
Bottone 7x7
7x7 - 2³/₄"x2³/₄"



AM8S Etic Ulivo
Bottone 7x7
7x7 - 2³/₄"x2³/₄"



AM8Q Etic Rovere Bianco
Bottone 7x7
7x7 - 2³/₄"x2³/₄"



AM8U Etic Rovere Grigio
Bottone 7x7
7x7 - 2³/₄"x2³/₄"



AM8W Etic Ebano
Bottone 7x7
7x7 - 2³/₄"x2³/₄"



ADQ2 Marvel Statuario
Select Angolo 7x7
Lappato
7x7 - 2³/₄"x2³/₄"



ADQ6 Marvel Grey
Fleury Angolo 7x7
Lappato
7x7 - 2³/₄"x2³/₄"



ADQ7 Marvel Noir St.
Laurent Angolo 7x7
Lappato
7x7 - 2³/₄"x2³/₄"



ADQ4 Marvel Crema
Delicato Angolo 7x7
Lappato
7x7 - 2³/₄"x2³/₄"



ADQ3 Marvel Travertino
Alabastrino Angolo 7x7
Lappato
7x7 - 2³/₄"x2³/₄"



ADQ5 Marvel Travertino
Silver Angolo 7x7
Lappato
7x7 - 2³/₄"x2³/₄"



ASJ3 Marvel Calacatta
Angolo 7x7 Lappato
7x7 - 2³/₄"x2³/₄"



ASJ4 Marvel Moon
Angolo 7x7 Lappato
7x7 - 2³/₄"x2³/₄"



ASJ8 Marvel Grey
Angolo 7x7 Lappato
7x7 - 2³/₄"x2³/₄"



ASJ5 Marvel Champagne
Angolo 7x7 Lappato
7x7 - 2³/₄"x2³/₄"



ASJ6 Marvel Beige
Angolo 7x7 Lappato
7x7 - 2³/₄"x2³/₄"



ASJ7 Marvel Bronze
Angolo 7x7 Lappato
7x7 - 2³/₄"x2³/₄"

TRIM TILES / PEZZI SPECIALI

p. 424

	Battiscopa 7,2x90 2 ⁷ / ₈ "x35 ³ / ₈ "	Scalino * 22,5x90 8 ⁷ / ₈ "x35 ³ / ₈ "	Scalino Angolare 22,5x22,5 - 8 ⁷ / ₈ "x8 ⁷ / ₈ "		Battiscopa Sag. Scala 7,2x30 - 2 ⁷ / ₈ "x11 ³ / ₄ "		Elemento L. Strutturato * 22,5x90 H. 4 8 ⁷ / ₈ "x35 ³ / ₈ " H. 1 ¹ / ₈ "
			DX *	SX *	DX *	SX *	
Rovere Bianco	AM75	AM96	ANAE	ANCV	ANAL	ANCN	AM9Y
Rovere	AM76	AM97	ANAF	ANCW	ANCH	ANCO	AM9Z
Ulivo	AM77	AM98	ANAG	ANCX	ANCI	ANCP	AM91
Noce	AM78	AM99	ANAH	ANCZ	ANCI	ANCP	AM92
Rovere Grigio	AM79	ANAA	ANAI	ANC1	ANCK	ANCR	AM93
Palissandro	AM8A	ANAC	ANAJ	ANCØ	ANCL	ANCS	AM94
Ebano	AM8B	ANAD	ANAK	ANCY	ANCM	ANCU	AM95

* THESE PARTS ARE SUPPLIED TO ORDER | I PEZZI SONO DISPONIBILI SU ORDINAZIONE | Les pièces sont disponibles sur commande | Die Teile sind auf Bestellung lieferbar | Las piezas se hacen por encargo | Изготавливаются на заказ

UPEC p. 571

WOOD LOOK



Porcelain Tiles / Gres Porcellanato

COLOURED BODY PORCELAIN TILES - RECTIFIED MONOCALIBER
GRES PORCELLANATO COLORATO IN MASSA - RETTIFICATO MONOCALIBRO

Sizes	Thickness	Surface finish
25x150 cm - 9 ⁷ / ₈ "x59"	± 9 mm	Matte R9 A
22,5x90 cm - 8 ⁷ / ₈ "x35 ³ / ₈ "	± 9 mm	Matte R9 A
15x90 cm - 5 ⁷ / ₈ "x35 ³ / ₈ "	± 9 mm	Matte R9 A

Outdoor Paving and Wet Areas

OUTDOOR PAVING p. 408

Sizes	Thickness	Surface finish
22,5x90 cm - 8 ⁷ / ₈ "x35 ³ / ₈ "	± 9 mm	Grip R11 A+B+C
30x120 cm - 11 ³ / ₄ "x47 ¹ / ₄ "	± 20 mm	Textured R11 A+B+C



COLOURED BODY PORCELAIN TILES | GRES PORCELLANATO COLORATO IN MASSA | Grés cérame coloré dans la masse | Durchgefärbtes Feinsteinzeug | Gres porcelánico coloreado en masa | Керамический гранит окрашенный в массе
RECTIFIED MONOCALIBER | RETTIFICATO MONOCALIBRO | Rectifié mono-calibre | Geschliffen einkalibrig | Rectificado monocalibre | Ретифицированный в одном калибре



Etic Pro Porcelain Tiles / Gres Porcellanato

MATTE SURFACE / SUPERFICIE MATT

± 9 mm

25x150 cm 9 7/8" x 59"

- AV4I Etic Rovere Venice 25x150
- AV4K Etic Noce Hickory 25x150
- AV4J Etic Quercia Antique 25x150
- AV4L Etic Eucalipto Smoked 25x150

± 9 mm

22,5x90 cm 8 7/8" x 35 3/8"

- AV4M Etic Rovere Venice 22,5x90
- AV4O Etic Noce Hickory 22,5x90
- AV4N Etic Quercia Antique 22,5x90
- AV4P Etic Eucalipto Smoked 22,5x90

± 9 mm

15x90 cm 5 7/8" x 35 3/8"

- D183 Etic Rovere Venice 15x90
- D185 Etic Noce Hickory 15x90
- D184 Etic Quercia Antique 15x90
- D186 Etic Eucalipto Smoked 15x90

ROVERE VENICE



QUERCIA ANTIQUE



NOCE HICKORY



EUCALIPTO SMOKED



Etic Pro Porcelain Tiles / Gres Porcellanato

GRIP SURFACE / SUPERFICIE GRIP

± 9 mm

22,5x90 cm 8 7/8" x 35 3/8"

- AV4Y Etic Rovere Venice 22,5x90 Grip
- AV4Ø Etic Noce Hickory 22,5x90 Grip
- AV4Z Etic Quercia Antique 22,5x90 Grip
- AV41 Etic Eucalipto Smoked 22,5x90 Grip

ROVERE VENICE



QUERCIA ANTIQUE



NOCE HICKORY



EUCALIPTO SMOKED



V3 MODERATE VARIATION

Rovere Venice, Quercia Antique, Noce Hickory, Eucalipto Smoked

MATTE SURFACE | SUPERFICIE MATT | Surface Mat | Matt oberfläche | Superficie Mate | Матовая поверхность



V3 MODERATE VARIATION

Rovere Venice, Quercia Antique, Noce Hickory, Eucalipto Smoked

GRIP SURFACE | SUPERFICIE GRIP | Surface grip | Grip oberfläche | Superficie Grip | Grip поверхность

WOOD LOOK

325

WOOD LOOK



Etic Pro Porcelain Tiles / Gres Porcellanato

OUTDOOR PAVING ± 20 mm / PAVIMENTI DA ESTERNO ± 20 mm

± 20 mm

30x120 cm 11³/₄"x47¹/₂"

- AV42 Etic Rovere Venice 30x120 LASTRA 20mm
- AV44 Etic Noce Hickory 30x120 LASTRA 20mm
- AV43 Etic Quercia Antique 30x120 LASTRA 20mm
- AV45 Etic Eucalipto Smoked 30x120 LASTRA 20mm

ROVERE VENICE



QUERCIA ANTIQUE



NOCE HICKORY



EUCALIPTO SMOKED



Etic Pro Porcelain Tiles / Gres Porcellanato

DECOR RANGE / GAMMA DECORI



AWYE Etic Rovere Venice
Chevron Tatami A+B
74x22,2 - 29¹/₈"x8⁵/₈"

AWYG Etic Noce Hickory
Chevron Tatami A+B
74x22,2 - 29¹/₈"x8⁵/₈"

AWYF Etic Quercia Antique
Chevron Tatami A+B
74x22,2 - 29¹/₈"x8⁵/₈"

AWYH Etic Eucalipto Smoked
Chevron Tatami A+B
74x22,2 - 29¹/₈"x8⁵/₈"



AWVZ Etic Rovere Venice
Tatami
22,5x90 - 8⁷/₈"x35³/₈"



AWV1 Etic Noce Hickory
Tatami
22,5x90 - 8⁷/₈"x35³/₈"



AWVØ Etic Quercia Antique
Tatami
22,5x90 - 8⁷/₈"x35³/₈"

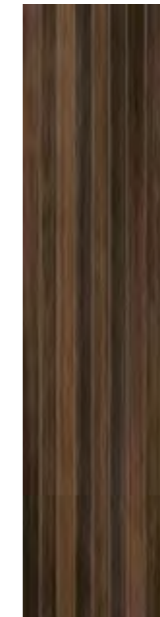

AWV2 Etic Eucalipto Smoked
Tatami
22,5x90 - 8⁷/₈"x35³/₈"

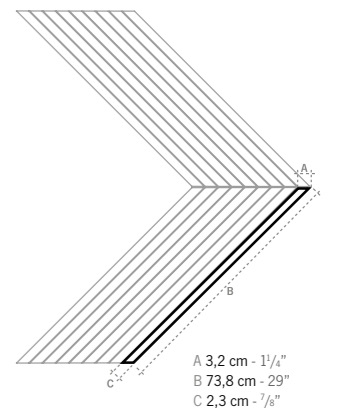

WOOD LOOK

327



**V3
MODERATE
VARIATION**

Rovere Venice,
Quercia Antique,
Noce Hickory,
Eucalipto Smoked

OUTDOOR PAVING | PAVIMENTI DA ESTERNO | Sols d'extérieur | Bodenbeläge für Außenbereiche | Pavimentos para exteriores | Уличная плитка

Etic Pro Porcelain Tiles / Gres Porcellanato

DECOR RANGE / GAMMA DECORI



AWYI Etic Rovere Venice Industrial 3D *
44x28,5 - 17³/₈"x11¹/₄"



AWYK Etic Noce Hickory Industrial 3D *
44x28,5 - 17³/₈"x11¹/₄"



AWYJ Etic Quercia Antique Industrial 3D *
44x28,5 - 17³/₈"x11¹/₄"



AWYL Etic Eucalipto Smoked Industrial 3D *
44x28,5 - 17³/₈"x11¹/₄"



AWV3 Etic Rovere Venice Herringbone
36,2x41,2 - 14¹/₈"x16¹/₈"



AWV5 Etic Noce Hickory Herringbone
36,2x41,2 - 14¹/₈"x16¹/₈"



AWV4 Etic Quercia Antique Herringbone
36,2x41,2 - 14¹/₈"x16¹/₈"



AWV6 Etic Eucalipto Smoked Herringbone
36,2x41,2 - 14¹/₈"x16¹/₈"



AWV7 Etic Rovere Venice Chevron A+B
35x34,5 - 13³/₄"x13³/₈"



AWV9 Etic Noce Hickory Chevron A+B
35x34,5 - 13³/₄"x13³/₈"



AWV8 Etic Quercia Antique Chevron A+B
35x34,5 - 13³/₄"x13³/₈"



AWVD Etic Eucalipto Smoked Chevron A+B
35x34,5 - 13³/₄"x13³/₈"

• **MULTI-THICKNESS MOSAIC, CLOSE JOINT INSTALLATION WITHOUT GROUTING.**
MOSAICO MULTISPESORE, POSA SENZA STUCCATURA A GIUNTO UNITO.
Mosaik multi-épaisseur, pose sans mastic avec joint nul.
Mosaik mit verschiedenen Stärken, fugenlose Verlegung ohne Mörtel.
Mosaico multiespesor, colocación sin mástico y sin juntas.
Мозаика разной толщины; укладка встык без затирки швов.

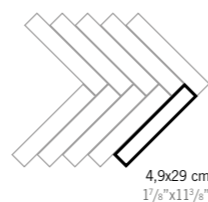
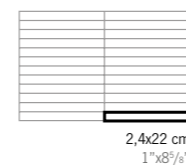

A 17 cm - 6³/₄"
B 39,8 cm - 15⁵/₈"
C 14,7 cm - 5³/₄"

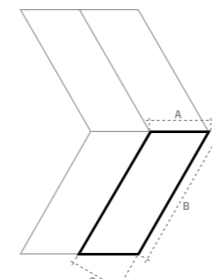

THE DECORATION CAN ONLY BE LAID ON THE WALL | IL DECORO SI PUÒ POSARE SOLO A RIVESTIMENTO
Décor uniquement mural | Das Dekor kann nur an der Wand verlegt werden | La decoración se puede colocar únicamente en paredes | Декор может быть уложен только на стену.



TRIM TILES / PEZZI SPECIALI

p. 424

UPEC p. 571

	Battiscopa 7,2x90 2 ⁷ / ₈ "x35 ³ / ₈ "	Scalino * 22,5x90 8 ⁷ / ₈ "x35 ³ / ₈ "	Scalino * 33x150 13"x59"	Scalino Angolare 22,5x22,5 - 8 ⁷ / ₈ "x8 ⁷ / ₈ "	Battiscopa Sag. Scala 7,2x30 - 2 ⁷ / ₈ "x11 ³ / ₄ "		Elemento L Grip * 22,5x90 H. 4 8 ⁷ / ₈ "x35 ³ / ₈ " H. 1 ⁵ / ₈ "	
				DX *	SX *	DX *	SX *	
Rovere Venice	AV68	AV7Z	AZFC	AV78	AV73	AV8G	AV8C	AV8K
Noce Hickory	AV7A	AV71	AZSH	AV8A	AV75	AV8I	AV8E	AV8M
Quercia Antique	AV69	AV70	AZSF	AV79	AV74	AV8H	AV8D	AV8L
Eucalipto Smoked	AV7B	AV72	AZSG	AV8B	AV77	AV8J	AV8F	AV8N

* THESE PARTS ARE SUPPLIED TO ORDER | I PEZZI SONO DISPONIBILI SU ORDINAZIONE | Les pièces sont disponibles sur commande | Die Teile sind auf Bestellung lieferbar | Las piezas se hacen por encargo | Изготавливаются на заказ



EXENCE

PORCELAIN TILES

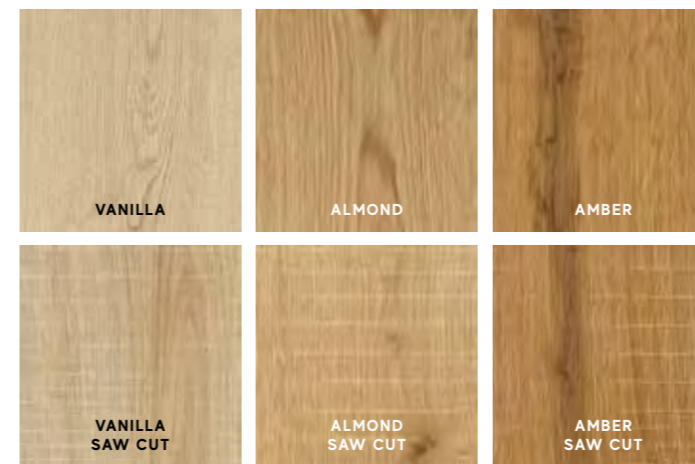

Porcelain Tiles / Gres Porcellanato

COLOURED BODY PORCELAIN TILES - RECTIFIED MONOCALIBER
GRES PORCELLANATO COLORATO IN MASSA - RETTIFICATO MONOCALIBRO

Sizes	Thickness	Surface finish
18,5x150 cm - 7 ¹ / ₄ "x59"	± 9 mm	Matte R10 A+B
20x120 cm - 7 ⁷ / ₈ "x47 ¹ / ₄ "	± 9 mm	Matte R10 A+B

Outdoor Paving and Wet Areas

OUTDOOR PAVING p. 408

Sizes	Thickness	Surface finish
18,5x150 cm - 7 ¹ / ₄ "x59"	± 9 mm	Grip R11 A+B+C
30x120 cm - 11 ³ / ₄ "x47 ¹ / ₄ "	± 20 mm	Textured R11 A+B+C



COLOURED BODY PORCELAIN TILES | GRES PORCELLANATO COLORATO IN MASSA | Grés cérame coloré dans la masse | Durchgefärbtes Feinsteinzeug | Gres porcelánico coloreado en masa | Керамический гранит окрашенный в массу
RECTIFIED MONOCALIBER | RETTIFICATO MONOCALIBRO | Rectifié mono-calibre | Geschliffen einkalbrig | Rettificado monocalibre | Ретифицированный в одном калибре



Exence Porcelain Tiles / Gres Porcellanato

MATTE SURFACE / SUPERFICIE MATT

± 9 mm

± 9 mm

18,5x150 cm 7 1/4"x59"
AOUH Exence Vanilla 18,5x150
AL88 Exence Amber 18,5x150
AL87 Exence Almond 18,5x150

20x120 cm 7 7/8"x47 1/4"
AO47 Exence Vanilla 20x120
AO49 Exence Amber 20x120
AO48 Exence Almond 20x120

± 9 mm

18,5x150 cm 7 1/4"x59"
AOUN Exence Vanilla Saw Cut 18,5x150
AOUM Exence Amber Saw Cut 18,5x150
AOUL Exence Almond Saw Cut 18,5x150

VANILLA

ALMOND

AMBER

VANILLA

ALMOND

AMBER



WOOD LOOK

WOOD LOOK



**V2
SLIGHT
VARIATION**

Vanilla,
Amber,
Almond



**V2
SLIGHT
VARIATION**

Vanilla,
Amber,
Almond



Exence Porcelain Tiles / Gres Porcellanato

GRIP SURFACE / SUPERFICIE GRIP

± 9 mm

18,5x150 cm 7 1/4"x59"
AOUK Exence Vanilla 18,5x150 Grip
AOUJ Exence Amber 18,5x150 Grip
AOUI Exence Almond 18,5x150 Grip

VANILLA



ALMOND



AMBER



Exence Porcelain Tiles / Gres Porcellanato

OUTDOOR PAVING ± 20 mm / PAVIMENTI DA ESTERNO ± 20 mm

± 20 mm

30x120 cm 11 3/4"x47 1/4"
A2RY Exence Almond 30x120 20 mm
A2RZ Exence Amber 30x120 20 mm

ALMOND



AMBER

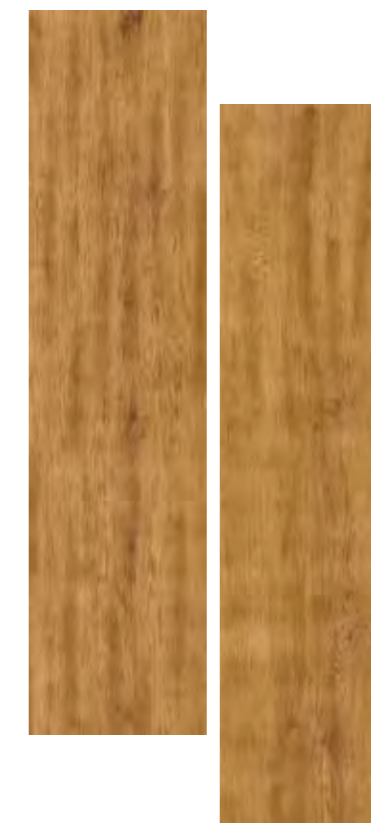

WOOD LOOK

WOOD LOOK



V2 SLIGHT VARIATION

Vanilla,
Amber,
Almond

GRIP SURFACE | SUPERFICIE GRIP | Surface grip | Grip oberfläche | Superficie Grip | Grip поверхность



V2 SLIGHT VARIATION

Vanilla,
Amber,
Almond

OUTDOOR PAVING | PAVIMENTI DA ESTERNO | Sols d'extérieur | Bodenbeläge für Außenbereiche | Pavimentos para exteriores | Уличная плитка

Exence Porcelain Tiles / Gres Porcellanato

DECOR RANGE / GAMMA DECORI

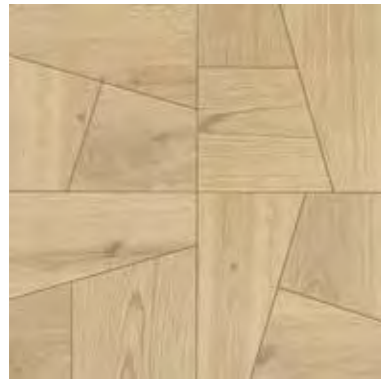

AOUU Exence
Vanilla Square
56,1x56,1 - 22"x22"

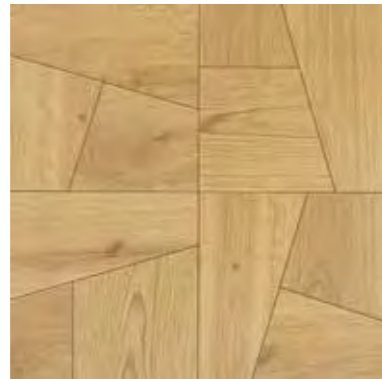

AOUV Exence
Almond Square
56,1x56,1 - 22"x22"



AOUW Exence
Amber Square
56,1x56,1 - 22"x22"

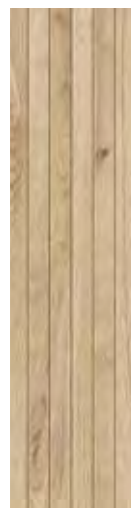

AOURL Exence
Vanilla Tatami
18,5x75 - 7 1/4"x29 1/2"



AOUS Exence
Almond Tatami
18,5x75 - 7 1/4"x29 1/2"



AOUT Exence
Amber Tatami
18,5x75 - 7 1/4"x29 1/2"



AOUG Exence
Vanilla Chevron
32,5x45 - 12 3/4"x17 3/4"



AMBJ Exence
Almond Chevron
32,5x45 - 12 3/4"x17 3/4"



AMBL Exence
Amber Chevron
32,5x45 - 12 3/4"x17 3/4"



atlas concorde

TRIM TILES / PEZZI SPECIALI

p. 424

UPEC p. 571

		Battiscopa 7,2x150 - 2 7/8"x59"		Battiscopa 7,2x120 - 2 7/8"x47 1/4"		Scalino* 33x150 - 13"x59"		Scalino Angolare* 33x33 - 13"x13"		Battiscopa Sag. Scala 7,2x30 - 2 7/8"x11 1/4"		Elemento L Grip* 18,5x150 H. 4 - 7 1/4"x59"	
								SX*	DX*	SX*	DX*		
	Vanilla	AOUX	APC4	AOUY	AOU0	AOUZ	AOU2	AOU1	AOZI				
	Almond	AMA2	APC5	AMA6	AMBA	AMA8	AMBG	AMBE	AOZJ				
	Amber	AMA5	APC6	AMA7	AMBD	AMA9	AMBH	AMBF	AOZK				

* THESE PARTS ARE SUPPLIED TO ORDER | I PEZZI SONO DISPONIBILI SU ORDINAZIONE | Les pièces sont disponibles sur commande | Die Teile sind auf Bestellung lieferbar | Las piezas se hacen por encargo | Изготавливаются на заказ

atlas concorde

HEARTWOOD

PORCELAIN TILES

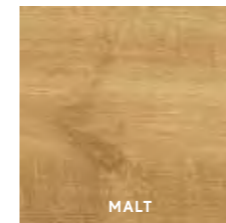

MALT

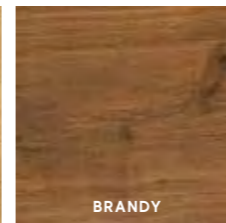

BRANDY

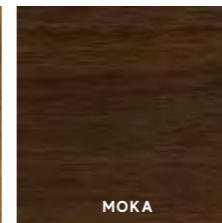

MOKA

Porcelain Tiles / Gres Porcellanato

COLOURED BODY PORCELAIN TILES - RECTIFIED MONOCALIBER
GRES PORCELLANATO COLORATO IN MASSA - RETTIFICATO MONOCALIBRO

Sizes	Thickness	Surface finish
18,5x150 cm - 7 ¹ / ₄ "x59"	± 9 mm	Matte R9 A
20x120 cm - 7 ⁷ / ₈ "x47 ¹ / ₄ "	± 9 mm	Matte R10 A+B



atlas concorde

COLOURED BODY PORCELAIN TILES | GRES PORCELLANATO COLORATO IN MASSA | Grés cérame coloré dans la masse | Durchgefärbtes Feinsteinzeug | Gres porcelánico coloreado en masa | Керамический гранит окрашенный в массе
RECTIFIED MONOCALIBER | RETTIFICATO MONOCALIBRO | Rectifié mono-calibre | Geschliffen einkalibrig | Rectificado monocalibrrel Ретицированный в одном калибре



Heartwood Porcelain Tiles / Gres Porcellanato

MATTE SURFACE / SUPERFICIE MATT

± 9 mm

18,5x150 cm 7 1/8"x59"

- AL68 Heartwood Malt 18,5x150
- AL84 Heartwood Brandy 18,5x150
- AL69 Heartwood Moka 18,5x150



± 9 mm

20x120 cm 7 7/8"x47 1/4"

- AL7E Heartwood Malt 20x120
- AL85 Heartwood Brandy 20x120
- AL7F Heartwood Moka 20x120

MALT



BRANDY



MOKA



MALT



BRANDY



MOKA



WOOD LOOK

WOOD LOOK



V3 MODERATE VARIATION
Malt,
Brandy,
Moka



V3 MODERATE VARIATION
Malt,
Brandy,
Moka

Heartwood Porcelain Tiles / Gres Porcellanato

DECOR RANGE / GAMMA DECORI



AOYG Heartwood Malt Mansion Weave
34,6x40 - 13⁷/₈"x15³/₄"



AOYH Heartwood Brandy Mansion Weave
34,6x40 - 13⁷/₈"x15³/₄"



AOYJ Heartwood Moka Mansion Weave
34,6x40 - 13⁷/₈"x15³/₄"



AO3K Heartwood Malt Marble Chevron
29,4x28,7 - 11⁵/₈"x11³/₈"
Malt + Marvel Black Atlantis



AO3L Heartwood Brandy Marble Chevron
29,4x28,7 - 11⁵/₈"x11³/₈"
Brandy + Marvel Black Atlantis



AOYI Heartwood Moka Marble Chevron
29,4x28,7 - 11⁵/₈"x11³/₈"
Moka + Marvel Black Atlantis



AOYD Heartwood Malt Tatami
18,5x75 - 7¹/₄"x29¹/₂"



AOYE Heartwood Brandy Tatami
18,5x75 - 7¹/₄"x29¹/₂"



AOYF Heartwood Moka Tatami
18,5x75 - 7¹/₄"x29¹/₂"



atlas concorde

WOOD LOOK

WOOD LOOK

TRIM TILES / PEZZI SPECIALI

p. 424

LUPEC p. 571

		Battiscopa 7,2x150 - 2 ⁷ / ₈ "x59"		Battiscopa 7,2x120 - 2 ⁷ / ₈ "x47 ¹ / ₄ "		Scalino * 33x150 - 13"x59"		Scalino Angolare * 33x33 - 13"x13"		Battiscopa Sag. Scala 7,2x30 - 2 ⁷ / ₈ "x11 ¹ / ₄ "	
								SX *	DX *	SX *	DX *
	Malt	AMAH	AMAE	AMAK		AMAR	AMAN	AMAZ	AMAW		
	Brandy	AMAI	AMAF	AMAL		AMAU	AMAO	AMAØ	AMAX		
	Moka	AMAJ	AMAG	AMAM		AMAV	AMAQ	AMA1	AMAY		

* THESE PARTS ARE SUPPLIED TO ORDER | I PEZZI SONO DISPONIBILI SU ORDINAZIONE | Les pièces sont disponibles sur commande | Die Teile sind auf Bestellung lieferbar | Las piezas se hacen por encargo | Изготавливаются на заказ



NASH
PORCELAIN TILES

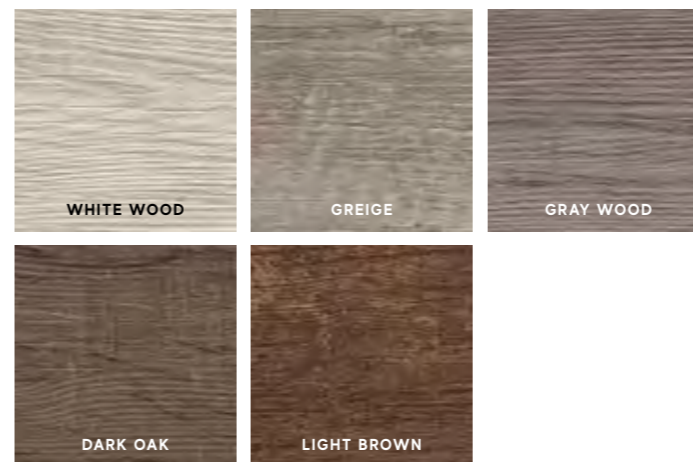

Porcelain Tiles / Gres Porcellanato

COLOURED BODY PORCELAIN TILES - RECTIFIED MONOCALIBER
GRES PORCELLANATO COLORATO IN MASSA - RETTIFICATO MONOCALIBRO

Sizes	Thickness	Surface finish
18,5x150 cm - 7 ¹ / ₄ "x59"	± 9 mm	Matte R10 A+B
20x120 cm - 7 ⁷ / ₈ "x47 ¹ / ₄ "	± 9 mm	Matte R10 A+B
7,5x60 cm - 3"x23 ⁵ / ₈ "	± 8,5 mm	Matte R10 A

Outdoor Paving and Wet Areas

OUTDOOR PAVING p. 408

Sizes	Thickness	Surface finish
20x120 cm - 7 ⁷ / ₈ "x47 ¹ / ₄ "	± 9 mm	Grip R11 A+B+C



COLOURED BODY PORCELAIN TILES | GRES PORCELLANATO COLORATO IN MASSA | Grès cérame coloré dans la masse | Durchgefärbtes Feinsteinzeug | Gres porcelánico coloreado en masa | Керамический гранит окрашенный в массе
RECTIFIED MONOCALIBER | RETTIFICATO MONOCALIBRO | Rectifié mono-calibre | Geschliffen einkalibrig | Rettificato monocaltbre | Ретифицированный в одном калибре
NON RECTIFIED | NON RETTIFICATO | Non rectifié | Nicht rektifiziert | No rectificada | Неретифицированные



Nash Porcelain Tiles / Gres Porcellanato

MATTE SURFACE / SUPERFICIE MATT

± 9 mm

18,5x150 cm 7 1/4" x 59"

- AN2D Nash White Wood 18,5x150
- AN2E Nash Greige 18,5x150
- AN2F Nash Gray Wood 18,5x150
- AN2G Nash Dark Oak 18,5x150
- AN2H Nash Light Brown 18,5x150

WHITE WOOD



GREIGE



GRAY WOOD



DARK OAK



LIGHT BROWN

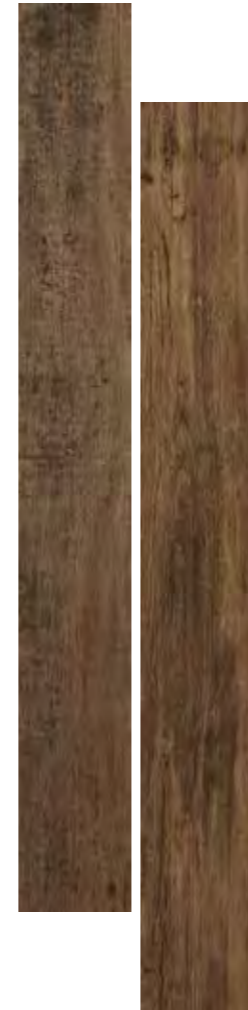

± 9 mm

20x120 cm 7 7/8" x 47 1/4"

- AN2I Nash White Wood 20x120
- AN2J Nash Greige 20x120
- AN2K Nash Gray Wood 20x120
- AN2L Nash Dark Oak 20x120
- AN2M Nash Light Brown 20x120

WHITE WOOD



GREIGE



GRAY WOOD



DARK OAK

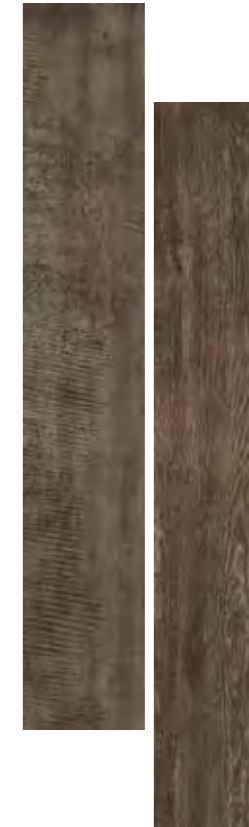

LIGHT BROWN

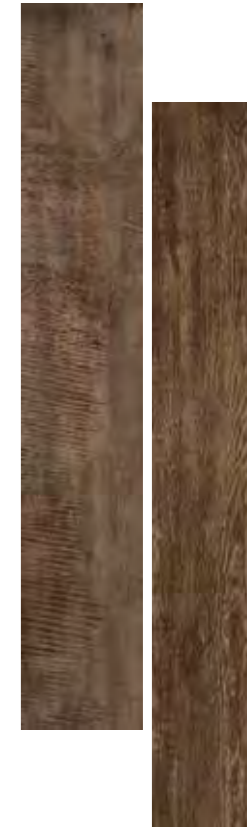

NON RECTIFIED / NON RETTIFICATO

± 8,5 mm

7,5x60 cm 3" x 23 5/8"

- AN2N Nash White Wood 7,5x60
- AN2O Nash Greige 7,5x60
- AN2Q Nash Gray Wood 7,5x60

WHITE WOOD



GREIGE



GRAY WOOD



V3 MODERATE VARIATION

White Wood, Greige, Gray Wood, Dark Oak, Light Brown



V3 MODERATE VARIATION

White Wood, Greige, Gray Wood, Dark Oak, Light Brown



Nash Porcelain Tiles / Gres Porcellanato

GRIP SURFACE / SUPERFICIE GRIP

± 9 mm

20x120 cm 7⁷/₈"x47¹/₄"
 AKCQ Nash White Wood 20x120 Grip
 AKCR Nash Greige 20x120 Grip
 AKCT Nash Gray Wood 20x120 Grip
 AKCU Nash Dark Oak 20x120 Grip
 AKCV Nash Light Brown 20x120 Grip

WHITE WOOD

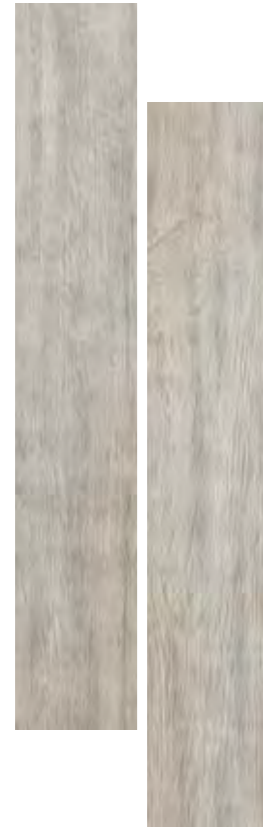

GREIGE



GRAY WOOD



DARK OAK



LIGHT BROWN

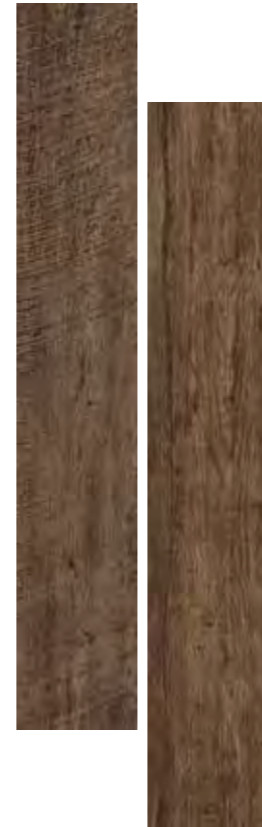

Nash Porcelain Tiles / Gres Porcellanato

DECOR RANGE / GAMMA DECORI



AONW Nash White Wood Tatami
18,5x74,4 - 7¹/₄"x29³/₈"



AONX Nash Greige Tatami
18,5x74,4 - 7¹/₄"x29³/₈"



AONY Nash Gray Wood Tatami
18,5x74,4 - 7¹/₄"x29³/₈"



AONZ Nash Dark Oak Tatami
18,5x74,4 - 7¹/₄"x29³/₈"



AONØ Nash Light Brown Tatami
18,5x74,4 - 7¹/₄"x29³/₈"



AN9R Nash White Wood Chevron
32,5x45 - 12³/₄"x17³/₄"



AN9S Nash Greige Chevron
32,5x45 - 12³/₄"x17³/₄"



AN9T Nash Gray Wood Chevron
32,5x45 - 12³/₄"x17³/₄"



AN9U Nash Dark Oak Chevron
32,5x45 - 12³/₄"x17³/₄"



AN9V Nash Light Brown Chevron
32,5x45 - 12³/₄"x17³/₄"

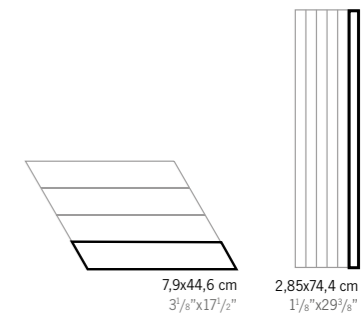

7,9x44,6 cm 3¹/₈"x17³/₄"
2,85x74,4 cm 1¹/₈"x29³/₈"

TRIM TILES / PEZZI SPECIALI

p. 424

UPEC p. 571

	Battiscopa 7,2x150 2 ⁷ / ₈ "x59"	Battiscopa 7,2x120 2 ⁷ / ₈ "x47 ¹ / ₄ "	Scalino * 33x150 13"x59"	Scalino Angolare 33x33 - 13"x13"		Battiscopa Sag. Scala 7,2x30 - 2 ⁷ / ₈ "x11 ³ / ₄ "	
				DX *	SX *	DX *	SX *
White Wood	AN3U	AN3O	AN2T	AN2Y	AN24	AN29	AN3F
Greige	AN3V	AN3P	AN2U	AN2Z	AN25	AN3A	AN3G
Gray Wood	AN3W	AN3Q	AN2V	AN21	AN26	AN3C	AN3H
Dark Oak	AN3X	AN3S	AN2W	AN22	AN27	AN3D	AN3I
Light Brown	AN3Y	AN3T	AN2X	AN23	AN28	AN3E	AN3J

* THESE PARTS ARE SUPPLIED TO ORDER | I PEZZI SONO DISPONIBILI SU ORDINAZIONE | Les pièces sont disponibles sur commande | Die Teile sind auf Bestellung lieferbar | Las piezas se hacen por encargo | Изготавливаются на заказ



V3 MODERATE VARIATION

White Wood,
Greige,
Gray Wood,
Dark Oak,
Light Brown



NID

PORCELAIN&WALL TILES

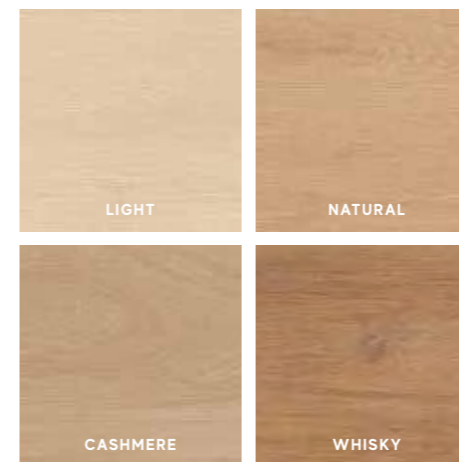

Porcelain Tiles / Gres Porcellanato

COLOURED BODY PORCELAIN TILES - RECTIFIED MONOCALIBER
GRES PORCELLANATO COLORATO IN MASSA - RETTIFICATO MONOCALIBRO

Sizes	Thickness	Surface finish
25x150 cm - 9 ⁷ / ₈ "x59"	± 9 mm	Matte R10 A
18,5x150 cm - 7 ¹ / ₄ "x59"	± 9 mm	Matte R10 A
15x90 cm - 5 ⁷ / ₈ "x35 ³ / ₈ "	± 9 mm	Matte R10 A

Outdoor Paving and Wet Areas

OUTDOOR PAVING p. 408

Sizes	Thickness	Surface finish
40x120 cm - 15 ³ / ₄ "x47 ¹ / ₄ "	± 20 mm	Textured R11 A+B+C

Wall Tiles / Rivestimento

WHITEBODY WALL TILES - RECTIFIED MONOCALIBER
RIVESTIMENTI IN PASTA BIANCA - RETTIFICATO MONOCALIBRO

3D Wall Tiles

Sizes	Thickness	Surface finish
40x80 cm - 15 ³ / ₄ "x31 ¹ / ₂ "	± 10 mm	Matte



8NWL NID 3D Wooden Mix Light-Cashmere 40x80
40x80 cm - 15³/₄"x31¹/₂"



8NWN NID 3D Wooden Mix Natural-Whisky 40x80
40x80 cm - 15³/₄"x31¹/₂"



**V2
SLIGHT
VARIATION**
Mix Natural-Whisky,
Mix Light-Cashmere



Nid Porcelain Tiles / Gres Porcellanato

MATTE SURFACE / SUPERFICIE MATT

± 9 mm

25x150 cm 9^{7/8}"x59"

AAL5 NID Light 25x150
AKSU NID Cashmere 25x150
AAL6 NID Natural 25x150
AAL7 NID Whisky 25x150

LIGHT



NATURAL



CASHMERE



WHISKY



± 9 mm

18,5x150 cm 7^{1/4}"x59"

AANK NID Light 18,5x150
AANI NID Cashmere 18,5x150
AANJ NID Natural 18,5x150
AANL NID Whisky 18,5x150

LIGHT



NATURAL



CASHMERE



WHISKY



± 9 mm

15x90 cm 5^{7/8}"x35^{3/4}"

D230 NID Light 15x90
D233 NID Cashmere 15x90
D231 NID Natural 15x90
D232 NID Whisky 15x90



OUTDOOR PAVING ± 20 mm / PAVIMENTI DA ESTERNO ± 20 mm

± 20 mm

40x120 cm 15^{3/4}"x47^{1/4}"

AAME NID Cashmere 40x120 LASTRA 20mm
AAMD NID Whisky 40x120 LASTRA 20mm

CASHMERE



WHISKY



V2 SLIGHT VARIATION
Light,
Natural,
Cashmere,
Whisky



V2 SLIGHT VARIATION
Light,
Natural,
Cashmere,
Whisky

Nid Porcelain Tiles / Gres Porcellanato

DECOR RANGE / GAMMA DECORI



AAOA NID Light Mosaico Esagono
30x35 - 11³/₄"x13³/₄"



AAOD NID Cashmere Mosaico Esagono
30x35 - 11³/₄"x13³/₄"



AAOB NID Natural Mosaico Esagono
30x35 - 11³/₄"x13³/₄"



AAOC NID Whisky Mosaico Esagono
30x35 - 11³/₄"x13³/₄"



AAN6 NID Light Herringbone
36,2x41,2 - 14¹/₈"x16¹/₈"



AAN9 NID Cashmere Herringbone
36,2x41,2 - 14¹/₈"x16¹/₈"



AAN7 NID Natural Herringbone
36,2x41,2 - 14¹/₈"x16¹/₈"



AAN8 NID Whisky Herringbone
36,2x41,2 - 14¹/₈"x16¹/₈"



AAOO NID Light Mosaico Intreccio
35x35 - 13³/₄"x13³/₄"



AAOR NID Cashmere Mosaico Intreccio
35x35 - 13³/₄"x13³/₄"



AAOP NID Natural Mosaico Intreccio
35x35 - 13³/₄"x13³/₄"



AAOQ NID Whisky Mosaico Intreccio
35x35 - 13³/₄"x13³/₄"



AAOF NID Natural Cassettoni
46,2x46,2 - 18¹/₄"x18¹/₄"
NID NATURAL + ARKSHADE GREY



AAOJ NID Natural Mosaico Domino
29,7x30,6 - 11⁵/₈"x12"
NID NATURAL + ARKSHADE GREY

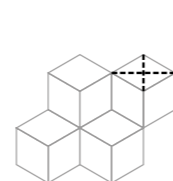
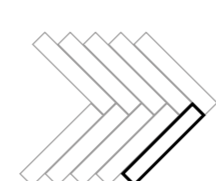
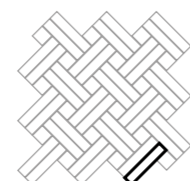
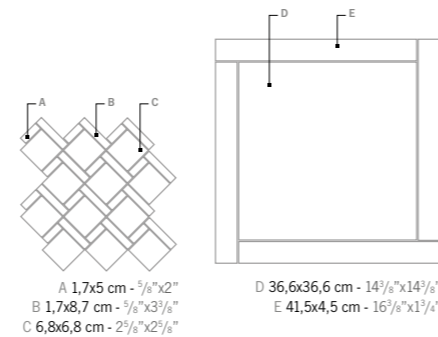

AANX NID Light Tatami
22,5x90 - 8⁷/₈"x35³/₈"



AAN1 NID Cashmere Tatami
22,5x90 - 8⁷/₈"x35³/₈"



AANY NID Natural Tatami
22,5x90 - 8⁷/₈"x35³/₈"



AANØ NID Whisky Tatami
22,5x90 - 8⁷/₈"x35³/₈"

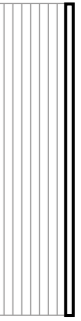

AAN2 NID Light Chevron
11,5x67 - 4¹/₂"x26³/₈"



AAN3 NID Natural Chevron
11,5x67 - 4¹/₂"x26³/₈"



AAN5 NID Cashmere Chevron
11,5x67 - 4¹/₂"x26³/₈"



AAN4 NID Whisky Chevron
11,5x67 - 4¹/₂"x26³/₈"

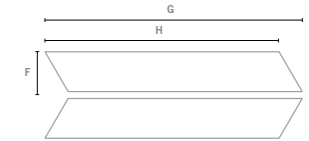

TRIM TILES / PEZZI SPECIALI

p. 424

UPEC p. 571

	Battiscopa 7,2x90 2 ⁷ / ₈ "x35 ³ / ₈ "	Scalino * 33x150 13"x59"	Scalino Angolare 33x33 - 13"x13"		Battiscopa Sag. Scala 7,2x30 - 2 ⁷ / ₈ "x11 ³ / ₄ "	
			DX *	SX *	DX *	SX *
Light	A8KF	A8KJ	A8KN	A8KR	A8KV	A8KZ
Natural	A8KG	A8KK	A8KO	A8KS	A8KW	A8KØ
Whisky	A8KH	A8KL	A8KP	A8KT	A8KX	A8K1
Cashmere	A8KI	A8KM	A8KQ	A8KU	A8KY	A8K2

* THESE PARTS ARE SUPPLIED TO ORDER | I PEZZI SONO DISPONIBILI SU ORDINAZIONE | Les pièces sont disponibles sur commande | Die Teile sind auf Bestellung lieferbar | Las piezas se hacen por encargo | Изготавливаются на заказ



atlas concorde

R O O M

PORCELAIN TILES

Porcelain Tiles / Gres Porcellanato

COLOURED BODY PORCELAIN TILES - RECTIFIED MONOCALIBER
GRES PORCELLANATO COLORATO IN MASSA - RETTIFICATO MONOCALIBRO

Sizes	Thickness	Surface finish
60x60cm - 23 ⁵ / ₈ "x23 ⁵ / ₈ "	± 9 mm	Matte R10 A
30x60 cm - 11 ³ / ₄ "x23 ⁵ / ₈ "	± 9 mm	Matte R10 A





Room Porcelain Tiles / Gres Porcellanato

MATTE SURFACE / SUPERFICIE MATT

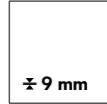

60x60 cm 23⁵/₈"x23⁵/₈"
 AZW6 Room White 60x60
 AZW7 Room Pearl 60x60
 AZW8 Room Cord 60x60
 AZW9 Room Grey 60x60

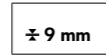

30x60 cm 11³/₄"x23⁵/₈"
 D124 Room White 30x60
 D125 Room Pearl 30x60
 D126 Room Cord 30x60
 D127 Room Grey 30x60

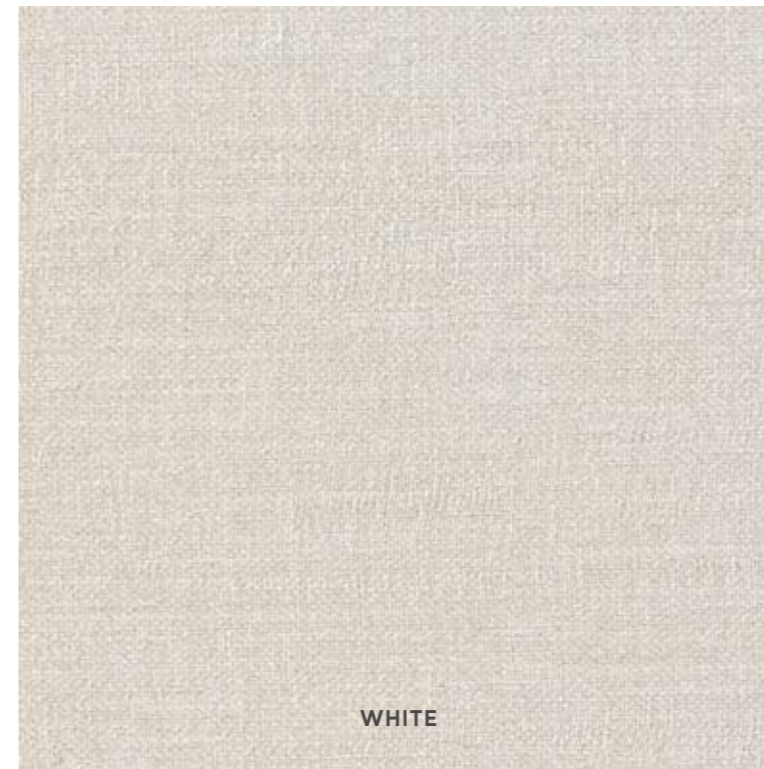

WHITE



PEARL



CORD

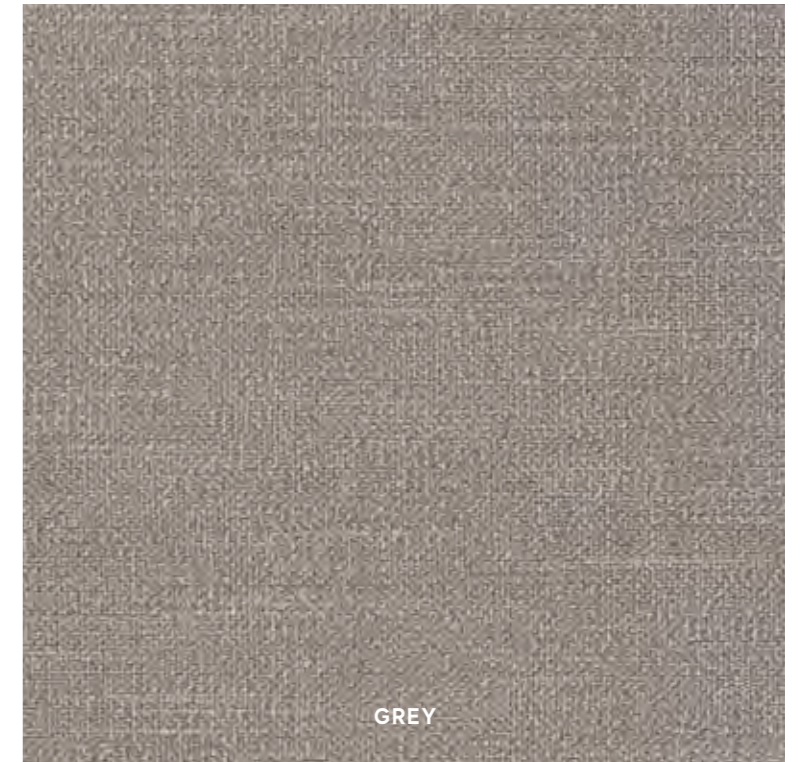

GREY

TRIM TILES / PEZZI SPECIALI

p. 424

UPEC p. 571

		Battiscopa 7,2x60 2 ⁷ / ₈ "x23 ⁵ / ₈ "	Battiscopa Digitale 4,6x60 1 ³ / ₄ "x23 ⁵ / ₈ "	Gradino * 30x60 11 ³ / ₄ "x23 ⁵ / ₈ "	Scalino * 33x60 13"x23 ⁵ / ₈ "	Scalino Angolare 33x33 - 13"x13"	Battiscopa Sag. Scala 7,2x30 - 2 ⁷ / ₈ "x11 ³ / ₄ "	DX *	SX *
	White	ATA8	ATA3	ATBC	ATBK	ATBU	ATBO	ATB3	ATBZ
	Cord	ATBA	ATA5	ATBE	ATBM	ATBW	ATBQ	ATB5	ATB1
	Grey	ATBB	ATA7	ATBF	ATBN	ATBY	ATBS	ATB6	ATB2
	Pearl	ATA9	ATA4	ATBD	ATBL	ATBV	ATBP	ATB4	ATB0

V1
UNIFORM APPEARANCE
 White,
 Pearl,
 Cord,
 Grey



Room Porcelain Tiles / Gres Porcellanato

MATTE SURFACE / SUPERFICIE MATT

CHECK

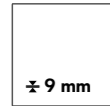

60x60 cm 23⁵/₈"x23⁵/₈"
AZXC Room Pearl Check 60x60
AZXF Room Cord Check 60x60

DOT

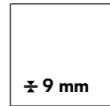

60x60 cm 23⁵/₈"x23⁵/₈"
AZXB Room Pearl Dot 60x60
AZXE Room Cord Dot 60x60

TWILL

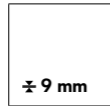

60x60 cm 23⁵/₈"x23⁵/₈"
AZXA Room Pearl Twill 60x60
AZXD Room Cord Twill 60x60

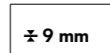

30x60 cm 11³/₄"x23⁵/₈"
D129 Room Pearl Dot 30x60
D131 Room Cord Dot 30x60

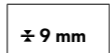

30x60 cm 11³/₄"x23⁵/₈"
D128 Room Pearl Twill 30x60
D130 Room Cord Twill 30x60

DECOR RANGE / GAMMA DECORI



AS5C Room Cord Mosaico Esagono Dek
30x35 - 11³/₄"x13³/₄"

AS5B Room Pearl Mosaico Esagono Dek
30x35 - 11³/₄"x13³/₄"



AS5D Room White Mosaico Bacchetta
30x30 - 11³/₄"x11³/₄"



AS5F Room Cord Mosaico Bacchetta
30x30 - 11³/₄"x11³/₄"



AS5E Room Pearl Mosaico Bacchetta
30x30 - 11³/₄"x11³/₄"



AS5G Room Grey Mosaico Bacchetta
30x30 - 11³/₄"x11³/₄"



PEARL CHECK



CORD CHECK



PEARL DOT



CORD DOT

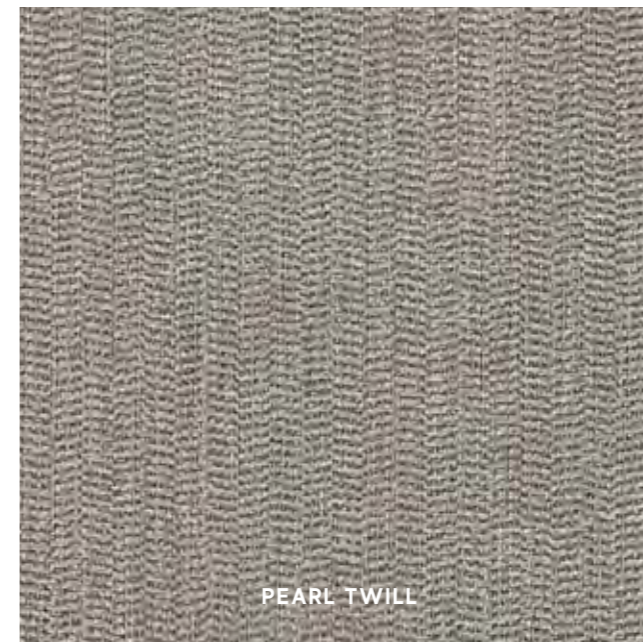

PEARL TWILL

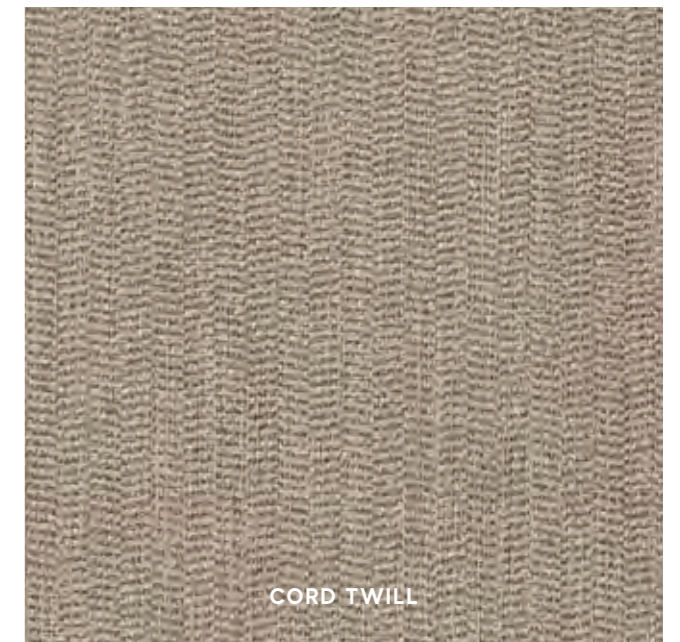

CORD TWILL

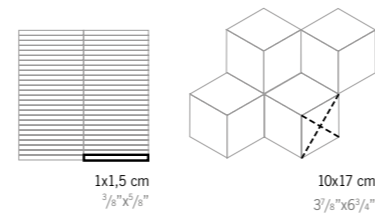

V1
UNIFORM APPEARANCE
Pearl Check,
Pearl Dot,
Pearl Twill,
Cord Check,
Cord Dot,
Cord Twill

Granigliati Porcelain Tiles / Gres Porcellanato

TECHNICAL PORCELAIN TILES
GRES PORCELLANATO TECNICO

MATTE SURFACE / SUPERFICIE MATT



3yØP Bianco Lasa 30 Matt 30x30 - 11³/₄"x11³/₄"
 3yØQ Libeccio 30 Matt 30x30 - 11³/₄"x11³/₄"
 3yØ4 Luserna 30 Matt 30x30 - 11³/₄"x11³/₄"
 3yØ3 Serizzo 30 Matt 30x30 - 11³/₄"x11³/₄"
 3yØL Grafite 30 Matt 30x30 - 11³/₄"x11³/₄"



AY4J Bianco Lasa 20 Matt 20x20 - 7⁷/₈"x7⁷/₈"
 AY4K Luserna 20 Matt 20x20 - 7⁷/₈"x7⁷/₈"
 AY4I Serizzo 20 Matt 20x20 - 7⁷/₈"x7⁷/₈"



AY4O Bianco Lasa 20 Sp. 12 mm. 20x20 - 7⁷/₈"x7⁷/₈"
 AY4P Serizzo 20 Sp. 12 mm. 20x20 - 7⁷/₈"x7⁷/₈"



V1 UNIFORM APPEARANCE

Bianco Lasa,
Libeccio,
Luserna,
Serizzo,
Grafite

TECHNICAL PORCELAIN TILES | GRES PORCELLANATO TECNICO | Grés cérame technique | Technisches Feinsteinzeug | Gres porcelánico técnico | Технический керамический гранит
 MATTE SURFACE | SUPERFICIE MATT | Surface Mat | Matt oberfläche | Superficie Mate | Матовая поверхность



TEXTURED SURFACE / SUPERFICIE STRUTTURATO

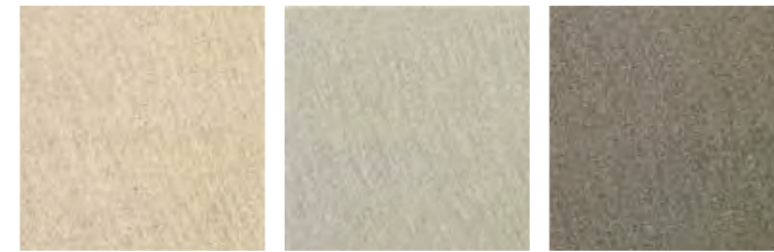

3ySP Bianco Lasa 30 Strutturato 30x30 - 11³/₄"x11³/₄"
 3yS4 Luserna 30 Strutturato 30x30 - 11³/₄"x11³/₄"
 3yS3 Serizzo 30 Strutturato 30x30 - 11³/₄"x11³/₄"



AY4L Bianco Lasa 20 Strutturato 20x20 - 7⁷/₈"x7⁷/₈"
 AY4M Serizzo 20 Strutturato 20x20 - 7⁷/₈"x7⁷/₈"















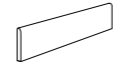
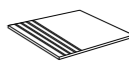
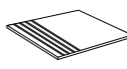

AT4S Bianco Lasa 20 Antisdrucchio P. Diam. 20x20 - 7⁷/₈"x7⁷/₈"

TRIM TILES / PEZZI SPECIALI

p. 424

UPEC p. 571

						
	Sguscia C.B. 10x20 - 3 ⁷ / ₈ "x7 ⁷ / ₈ "	Sguscia Ang. Est. C.B. H. 10 - 3 ⁷ / ₈ "	Sguscia Ang. Int. C.B. H. 10 - 3 ⁷ / ₈ "	Racc. a Pavimento 10x20 - 3 ⁷ / ₈ "x7 ⁷ / ₈ "	Angolo Esterno H. 10 - 3 ⁷ / ₈ "	Angolo Interno H. 10 - 3 ⁷ / ₈ "
	1WBP	8YEP	8YIP	1WØP	8WEP	8WAP
	1WB4	8YE4	8YI4	1WØ4	8WS4	8WA4
	1WB3	8YE3	8YI3	1WØ3	8WS3	8WA3
						
	Battiscopa Matt 10x30 - 3 ⁷ / ₈ "x11 ³ / ₄ "	Gradino Matt 30x30 - 11 ³ / ₄ "x11 ³ / ₄ "	Gradino Strutturato 30x30 - 11 ³ / ₄ "x11 ³ / ₄ "			
	6WØP	3yGP	3yRP			
	6WØL	3yGL	-			
	6WØQ	3yGQ	-			
	6WØ4	3yG4	3yR4			
	6WØ3	3yG3	3yR3			

Some items of the Granigliati collection are manufactured in France.
 Alcuni articoli della collezione Granigliati sono realizzati in Francia.

TECHNICAL PORCELAIN TILES | GRES PORCELLANATO TECNICO | Grés cérame technique | Technisches Feinsteinzeug | Gres porcelánico técnico | Технический керамический гранит
 TEXTURED SURFACE | SUPERFICIE STRUTTURATA | Surface structurée | Strukturiert oberfläche | Superficie estructurada | Структурная поверхность

Greencolors Porcelain Tiles / Gres Porcellanato

GLAZED PORCELAIN TILES
GRES PORCELLANATO SMALTATO

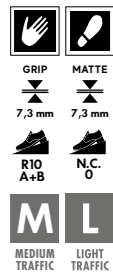

MATTE&GRIP SURFACE / SUPERFICIE MATT E GRIP

210A GC. Neve 20 2101 GC. Neve 20 Grip 20x20 - 7 7/8"x7 7/8"	210B GC. Ghiaccio 20 20x20 - 7 7/8"x7 7/8"	210C GC. Cemento 20 2103 GC. Cemento 20 Grip 20x20 - 7 7/8"x7 7/8"	210D GC. Fumo 20 20x20 - 7 7/8"x7 7/8"	210E GC. Notte 20 20x20 - 7 7/8"x7 7/8"	
210F GC. Avorio 20 2104 GC. Avorio 20 Grip 20x20 - 7 7/8"x7 7/8"	210G GC. Sabbia 20 20x20 - 7 7/8"x7 7/8"	210H GC. Corda 20 2106 GC. Corda 20 Grip 20x20 - 7 7/8"x7 7/8"	210I GC. Fango 20 20x20 - 7 7/8"x7 7/8"	210K GC. Moka 20 20x20 - 7 7/8"x7 7/8"	
210N GC. Menta 20 2107 GC. Menta 20 Grip 20x20 - 7 7/8"x7 7/8"	210O GC. Lime 20 20x20 - 7 7/8"x7 7/8"	210P GC. Prato 20 20x20 - 7 7/8"x7 7/8"	210W GC. Mais 20 20x20 - 7 7/8"x7 7/8"	210U GC. Mandarino 20 20x20 - 7 7/8"x7 7/8"	210T GC. Cremisi 20 20x20 - 7 7/8"x7 7/8"
210J GC. Celeste 20 20x20 - 7 7/8"x7 7/8"	210L GC. Indaco 20 2108 GC. Indaco 20 Grip 20x20 - 7 7/8"x7 7/8"	210M GC. Zaffiro 20 20x20 - 7 7/8"x7 7/8"	210Q GC. Glicine 20 20x20 - 7 7/8"x7 7/8"	210R GC. Lavanda 20 20x20 - 7 7/8"x7 7/8"	210S GC. Malva 20 20x20 - 7 7/8"x7 7/8"

TRIM TILES / PEZZI SPECIALI

p. 424

	3x20 - 1 1/8"x7 7/8" Canaletta Esterna	3x20 - 1 1/8"x7 7/8" Canaletta Interna	3x3 - 1 1/8"x1 1/8" Canaletta A/E	3x3 - 1 1/8"x1 1/8" Canaletta A/I	3x3 - 1 1/8"x1 1/8" Piede
GC. Neve	AKAB	AKAH	AKAN	AKAT	AKAZ
GC. Cemento	AKAC	AKAI	AKAO	AKAU	AKAØ
GC. Avorio	AKAD	AKAJ	AKAP	AKAV	AKA1
GC. Corda	AKAE	AKAK	AKAQ	AKAW	AKA2
GC. Menta	AKAF	AKAL	AKAR	AKAX	AKA3
GC. Indaco	AKAG	AKAM	AKAS	AKAY	AKA4

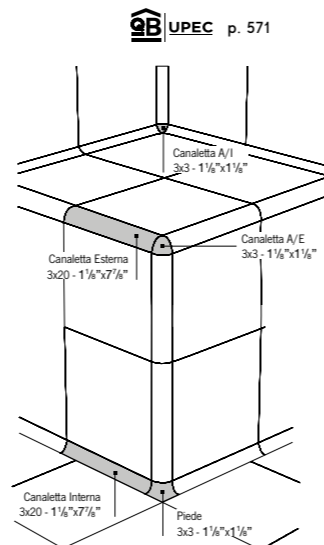

PEI 5: GC. Neve Grip, GC. Avorio Grip; PEI 4: GC. Cemento Grip, GC. Corda Grip, GC. Menta Grip, GC. Indaco Grip, GC. Neve, GC. Ghiaccio, GC. Cemento, GC. Avorio, GC. Sabbia, GC. Corda, GC. Lime, GC. Menta, GC. Glicine, GC. Celeste, GC. Lavanda, GC. Mais, GC. Mandarino, GC. Cremisi, GC. Fumo; PEI 3: GC. Notte, GC. Fango, GC. Prato, GC. Indaco, GC. Zaffiro, GC. Malva; PEI 2: GC. Moka.

GLAZED PORCELAIN TILES | GRES PORCELLANATO SMALTATO | Grés cérame émaillé | Glasiertes Feinsteinzeug | Gres porcelánico esmaltado | Глазурованный керамический гранит
MATTE SURFACE | SUPERFICIE MATT | Surface Mat | Matt oberfläche | Superficie Mate | Матовая поверхность
GRIP SURFACE | SUPERFICIE GRIP | Surface grip | Grip oberfläche | Superficie Grip | Grip поверхность

Groundtrack Porcelain Tiles / Gres Porcellanato

TECHNICAL PORCELAIN TILES
GRES PORCELLANATO TECNICO



MATTESURFACE / SUPERFICIE MATT



MT68 GT Yellow STOP
30x30 - 11 3/4"x11 3/4"

MT64 GT White STOP
30x30 - 11 3/4"x11 3/4"

MT72 GT Black STOP
30x30 - 11 3/4"x11 3/4"

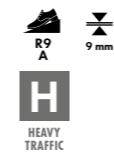
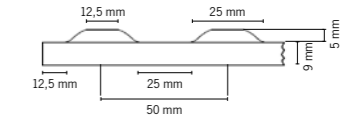

MT67 GT Yellow GO
30x30 - 11 3/4"x11 3/4"

MT63 GT White GO
30x30 - 11 3/4"x11 3/4"

MT71 GT Black GO
30x30 - 11 3/4"x11 3/4"

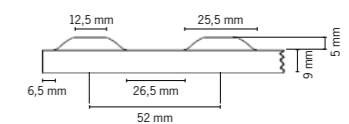

MT69 GT Yellow TURN
30x30 - 11 3/4"x11 3/4"

MT65 GT White TURN
30x30 - 11 3/4"x11 3/4"

MT73 GT Black TURN
30x30 - 11 3/4"x11 3/4"



MT70 GT Yellow CROSS
30x30 - 11 3/4"x11 3/4"

MT62 GT White CROSS
30x30 - 11 3/4"x11 3/4"

MT74 GT Black CROSS
30x30 - 11 3/4"x11 3/4"

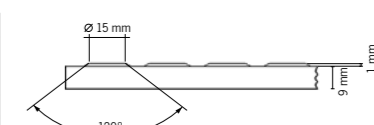

V1
UNIFORM
APPEARANCE

XL

LARGE SIZES | PORCELAIN TILES

COLOURED BODY PORCELAIN TILES - RECTIFIED MONOCALIBER
GRES PORCELLANATO COLORATO IN MASSA - RETTIFICATO MONOCALIBRO

 atlas concorde



RECTIFIED / RETTIFICATO

120x120 cm - 47¹/₄"x47¹/₄"
± 6, 9 mm

120x240 cm - 47¹/₄"x94¹/₂"
± 9 mm

120x278 cm - 47¹/₄"x109¹/₂"
± 6 mm

160x160 cm - 63"x63"
± 6 mm

160x320 cm - 63"x126"
± 6 mm

atlas concorde

atlasPLAN



NON-RECTIFIED / NON RETTIFICATO

162x324 cm - 63³/₄"x127¹/₂"
± 6, 12, 20 mm





atlas concorde

LARGE SIZES



atlas concorde

LARGE SIZES

XL Large Sizes

Porcelain Tiles / Gres Porcellanato

MARBLE LOOK

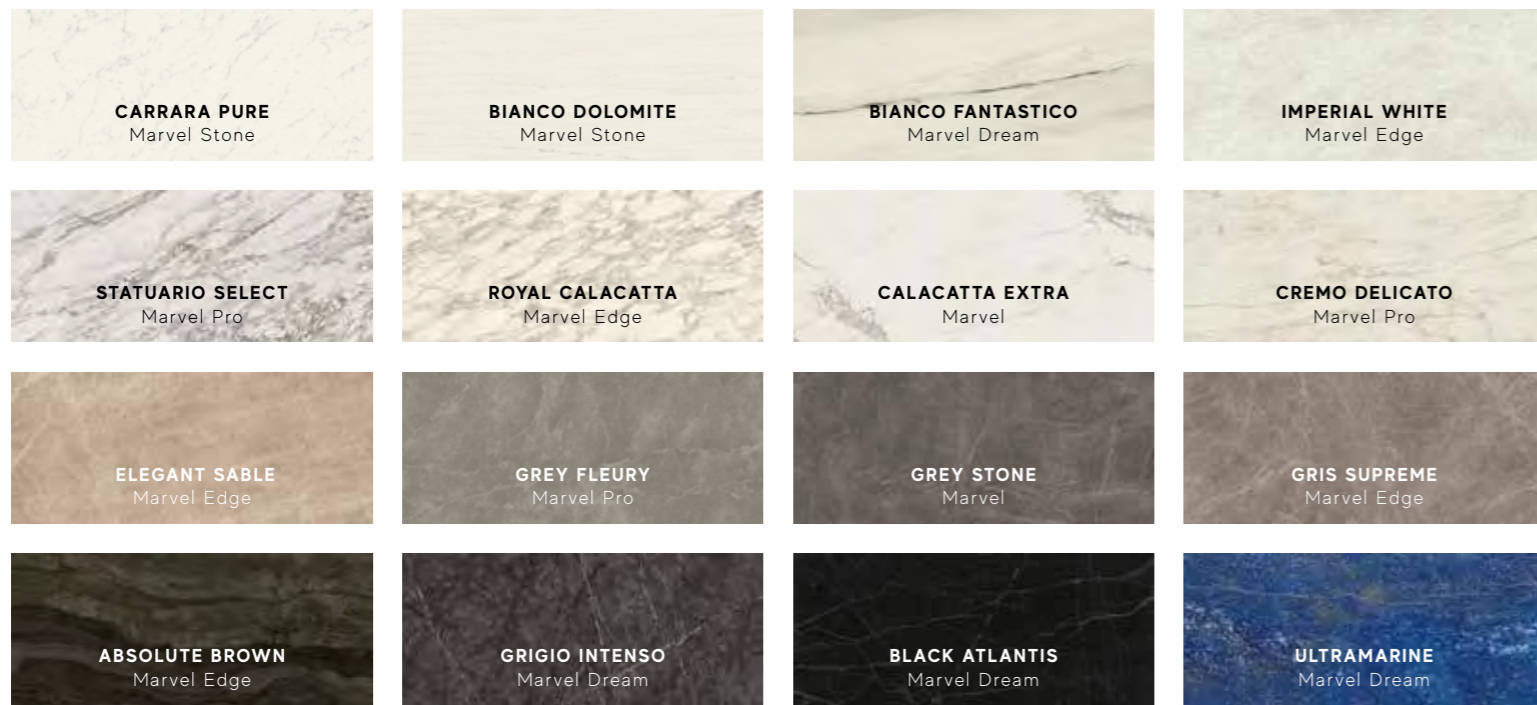

METAL LOOK

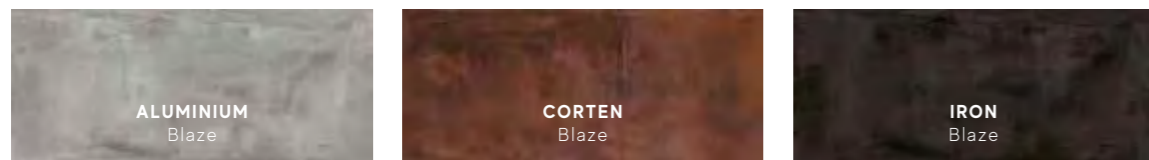

CONCRETE LOOK

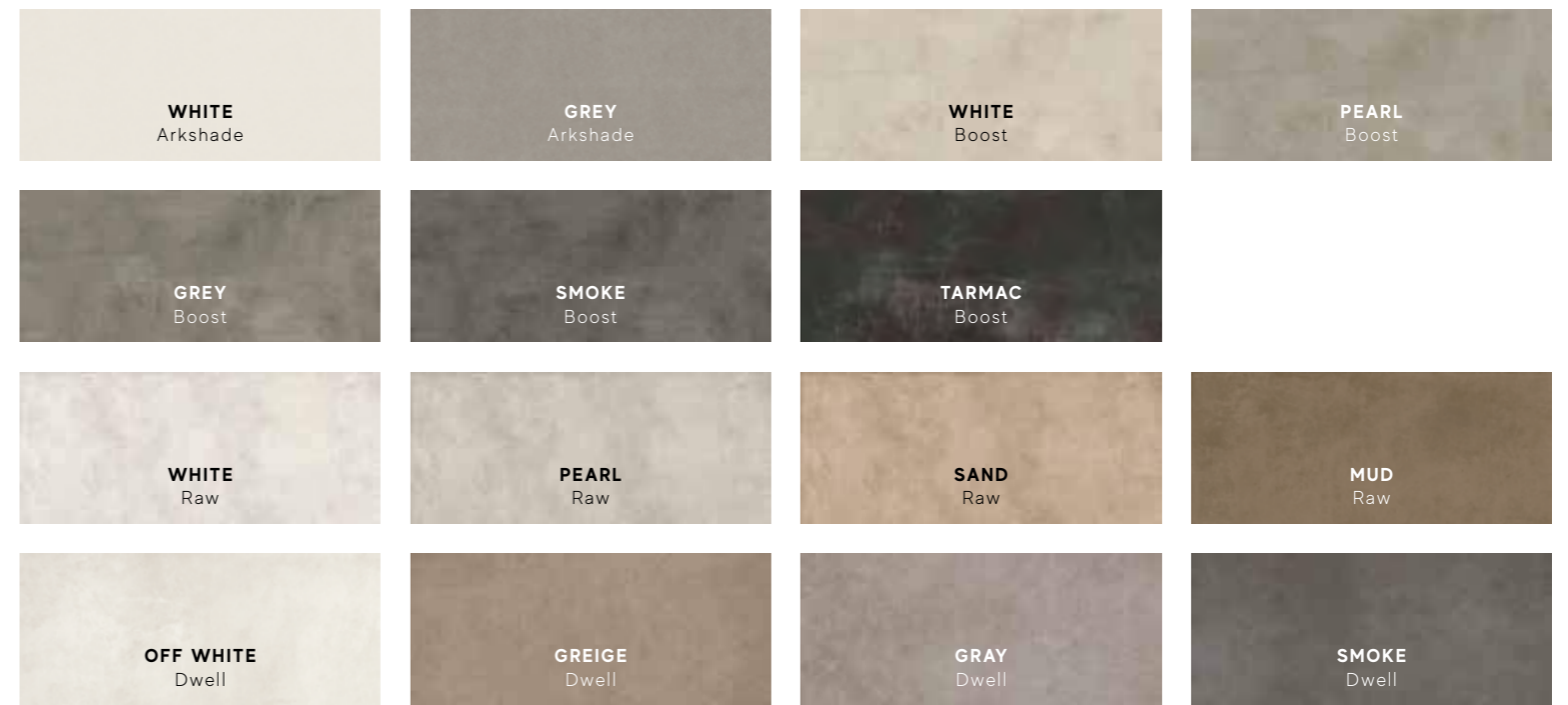

STONE LOOK

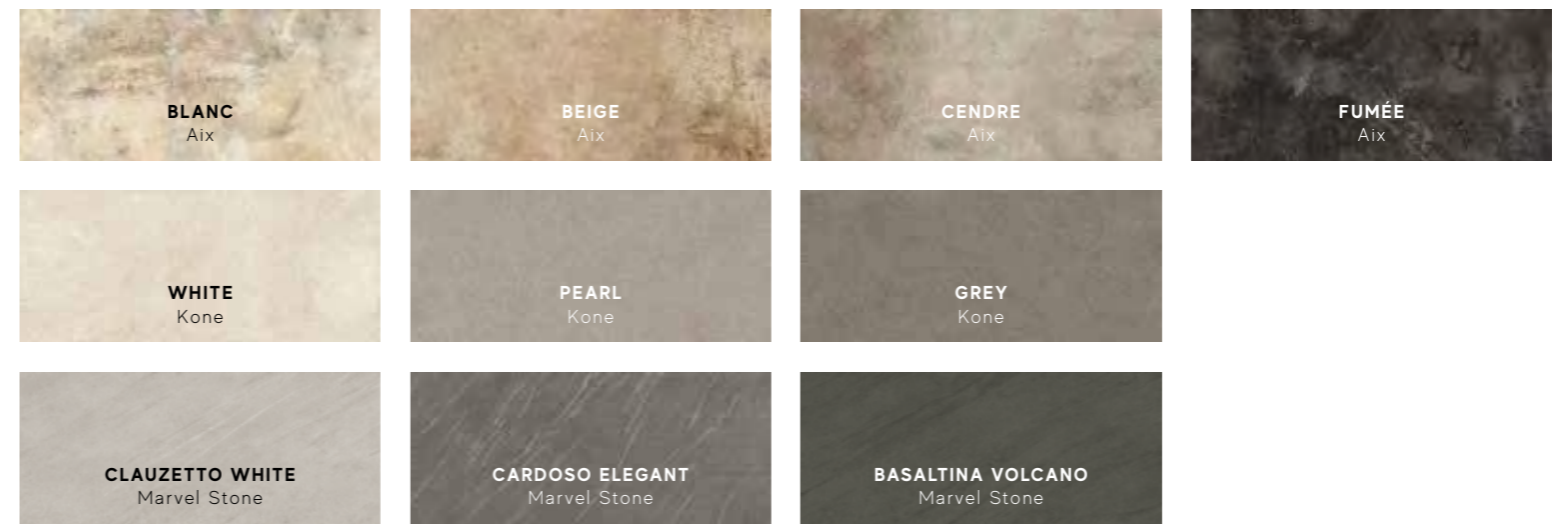

More choices for 162x324 cm Non-Rectified Size

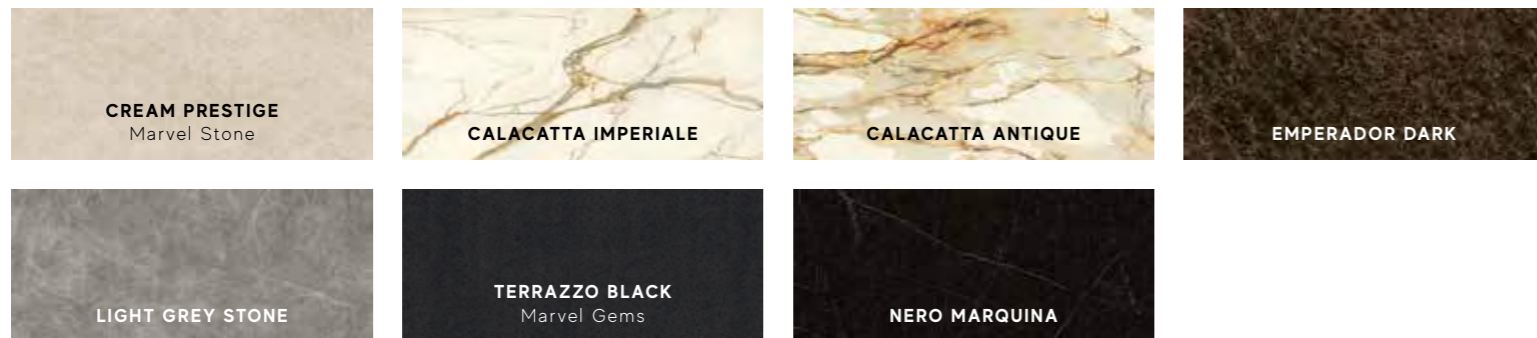

More choices for 162x324 cm Non-Rectified Size

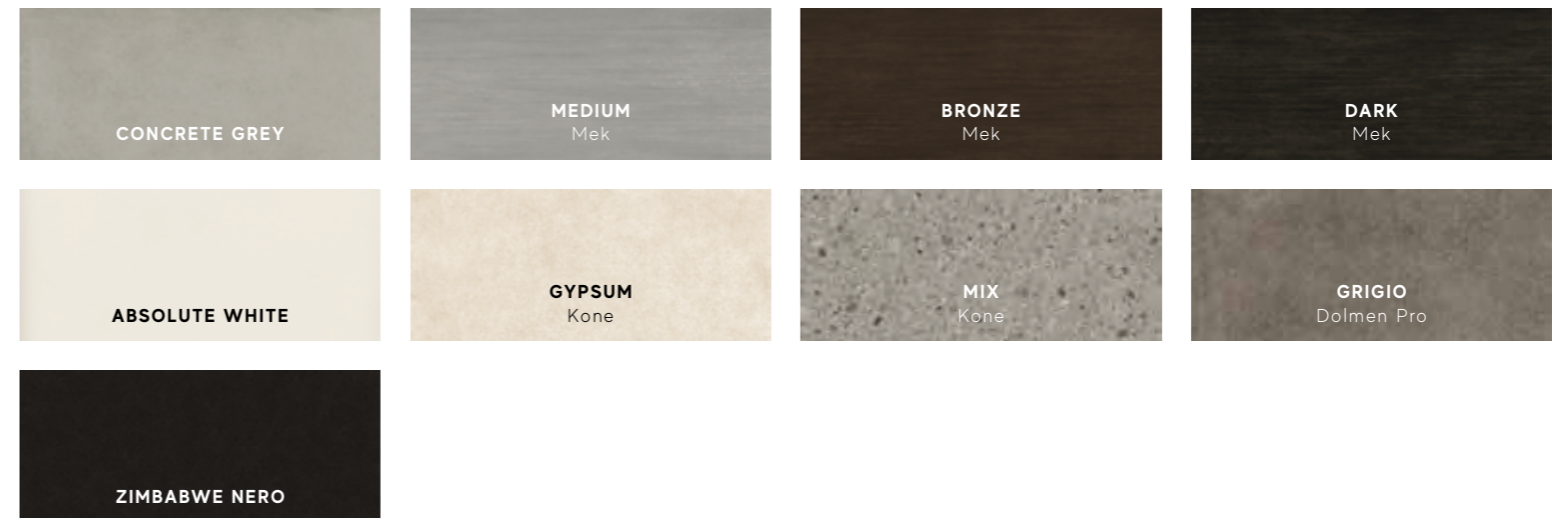

XL Large Sizes

Porcelain Tiles / Gres Porcellanato

MARBLE LOOK



Marvel Stone
CARRARA PURE

Sizes	Thickness	Surface finish
120x120 cm - 47 1/4"x47 1/4"	± 9 mm	Polished Matte
120x240 cm - 47 1/4"x94 1/2"	± 9 mm	Polished
120x278 cm - 47 1/4"x109 1/2"	± 6 mm	Polished Matte
162x324 cm - 63 3/4"x127 1/2"	± 12 mm	Silk

> NON-RECTIFIED

atlas^{PLAN} 162x324 cm - 63 3/4"x127 1/2"

- ▼
- A207 Marvel Carrara Pure 120x120
- AZTU Marvel Carrara Pure 120x120 Lappato
- AZTW Marvel Carrara Pure 120x240 Lappato
- A2RV Marvel Carrara Pure 120x278 Matt
- A2RW Marvel Carrara Pure 120x278 Lappato

- ▼
- AAVR Carrara Pure Silk - 12mm
- AAV3 Carrara Pure Silk - 12mm ST *



Marvel Stone
BIANCO DOLOMITE

Sizes	Thickness	Surface finish
120x120 cm - 47 1/4"x47 1/4"	± 9 mm	Polished Matte
120x240 cm - 47 1/4"x94 1/2"	± 9 mm	Polished
120x278 cm - 47 1/4"x109 1/2"	± 6 mm	Polished Matte
160x160 cm - 63"x63"	± 6 mm	Polished
160x320 cm - 63"x126"	± 6 mm	Polished

162x324 cm - 63 3/4"x127 1/2" ± 12 mm Lappato Lux

> NON-RECTIFIED

atlas^{PLAN} 162x324 cm - 63 3/4"x127 1/2"

- ▼
- A204 Marvel Bianco Dolomite 120x120 Matt
- AZTT Marvel Bianco Dolomite 120x120 Lappato
- AZTV Marvel Bianco Dolomite 120x240 Lappato
- A2RS Marvel Bianco Dolomite 120x278 Matt
- A0BP Marvel Bianco Dolomite 120x278 Lappato
- A0S3 Marvel Bianco Dolomite 160x160RT Lappato
- A0S5 Marvel Bianco Dolomite 160x320RT Lappato

- ▼
- AAVO Bianco Dolomite A Lap Lux - 12mm
- AAVG Bianco Dolomite A Lap Lux - 12mm ST *



Marvel Dream
BIANCO FANTASTICO

Sizes	Thickness	Surface finish
120x120 cm - 47 1/4"x47 1/4"	± 9 mm	Polished Matte
120x240 cm - 47 1/4"x94 1/2"	± 9 mm	Polished
120x278 cm - 47 1/4"x109 1/2"	± 6 mm	Polished Matte

- ▼
- A203 Marvel Bianco Fantastico 120x120 Matt
- AL7N Marvel Bianco Fantastico 120x120 Lappato
- A03P Marvel Bianco Fantastico 120x240 Lappato
- A2RR Marvel Bianco Fantastico 120x278 Matt
- A0SE Marvel Bianco Fantastico 120x278 Lappato

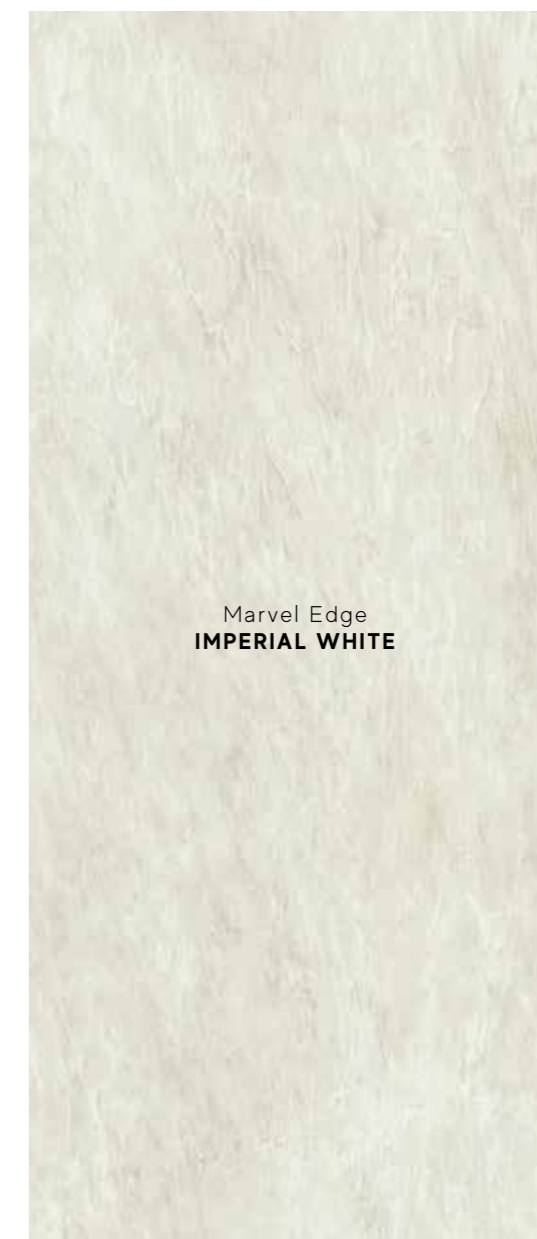

Marvel Edge
IMPERIAL WHITE

Sizes	Thickness	Surface Finish
120x120 cm - 47 1/4"x47 1/4"	± 9 mm	Polished
120x240 cm - 47 1/4"x94 1/2"	± 9 mm	Polished
120x278 cm - 47 1/4"x109 1/2"	± 6 mm	Polished

- ▼
- AENQ Marvel Imperial White 120x120 Lappato
- AENV Marvel Imperial White 120x240 Lappato
- A0BK Marvel Imperial White 120x278 Lappato

XL Large Sizes

Porcelain Tiles / Gres Porcellanato

MARBLE LOOK

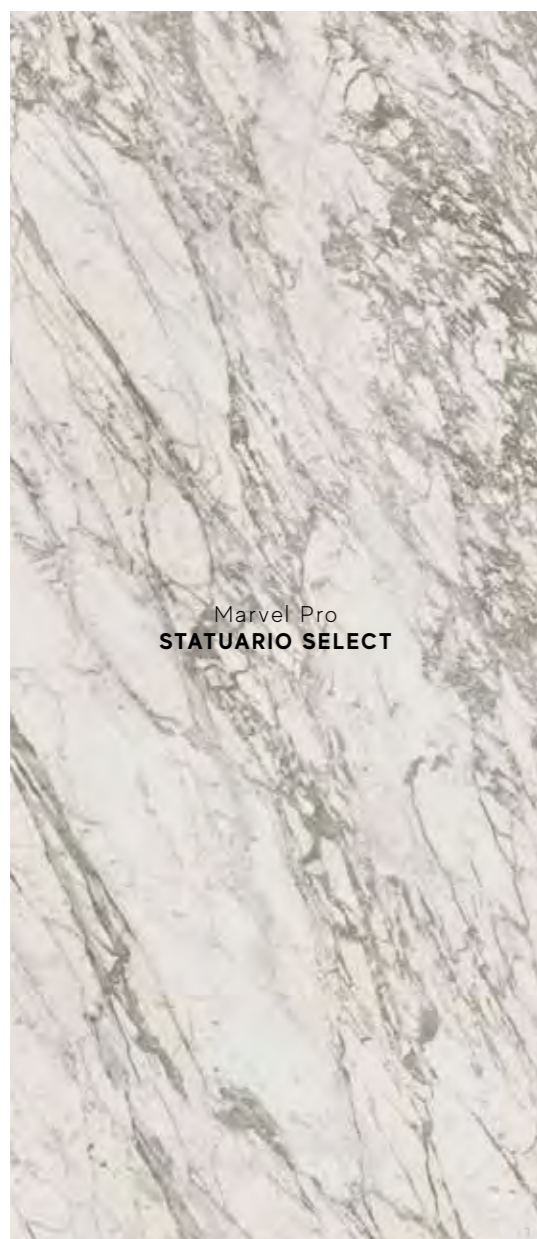

Marvel Pro
STATUARIO SELECT

Sizes	Thickness	Surface finish
120x120 cm - 47 1/4"x47 1/4"	± 9 mm	Polished
120x240 cm - 47 1/4"x94 1/2"	± 9 mm	Polished
120x278 cm - 47 1/4"x109 1/2"	± 6 mm	Polished
160x320 cm - 63"x126"	± 6 mm	Polished

- ▼
- AY2T Marvel Statuario Select 120x120 Lappato
- AY2P Marvel Statuario Select 120x240 Lappato
- A0BN Marvel Statuario Select 120x278 Lappato
- A0SV Marvel Statuario Select 160x320RT Lappato

atlasPLAN

162x324 cm - 63 3/4"x127 1/2" ± 12 mm Lappato Lux I Silk
NON-RECTIFIED

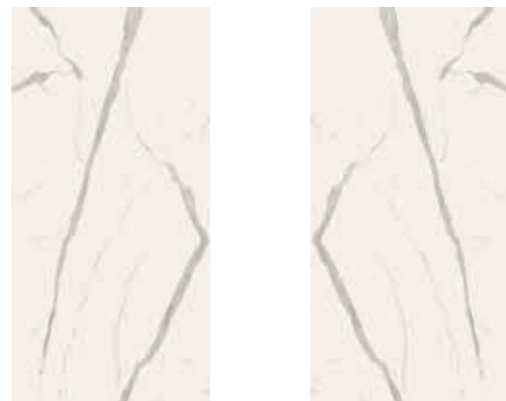

BOOKMATCH

- ▼
- ANV1 Statuario Select Lap Lux - 12mm
- ANV2 Statuario Select Lap Lux - 12mm ST *
- AMJ1 Statuario Select Silk - 12mm
- AMJ2 Statuario Select Silk - 12mm ST *
- ▼
- ANV3 Statuario Select Bookmatch Lap Lux - 12mm
- ANV4 Statuario Select Bookmatch Lap Lux - 12mm ST *
- AMJ3 Statuario Select Bookmatch Silk - 12mm
- AMJ4 Statuario Select Bookmatch Silk - 12mm ST *



Marvel Edge
ROYAL CALACATTA

Sizes	Thickness	Surface finish
120x120 cm - 47 1/4"x47 1/4"	± 9 mm	Polished
120x240 cm - 47 1/4"x94 1/2"	± 9 mm	Polished
120x278 cm - 47 1/4"x109 1/2"	± 6 mm	Polished

- ▼
- AENP Marvel Royal Calacatta 120x120 Lappato
- AENU Marvel Royal Calacatta 120x240 Lappato
- A0BH Marvel Royal Calacatta 120x278 Lappato

120x278 cm - 47 1/4"x109 1/2" ± 6 mm Polished

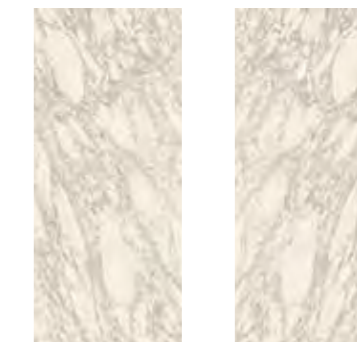

BOOKMATCH A

BOOKMATCH B

- ▼
- A0BI Marvel Royal Calacatta Bookmatch A 120x278 Lappato
- A0BJ Marvel Royal Calacatta Bookmatch B 120x278 Lappato

atlasPLAN

162x324 cm - 63 3/4"x127 1/2" ± 12 mm Lappato Lux I Silk
NON-RECTIFIED



BOOKMATCH

- ▼
- AA16 Calacatta Royal Lap Lux - 12mm
- AA17 Calacatta Royal Lap Lux - 12mm ST *
- AMJW Calacatta Royal Silk - 12mm
- AMJX Calacatta Royal Silk - 12mm ST *
- ▼
- ABFB Calacatta Royal Bookmatch Lap Lux - 12mm
- AA9M Calacatta Royal Bookmatch Lap Lux - 12mm ST *
- AMJY Calacatta Royal Bookmatch Silk - 12mm
- AMJZ Calacatta Royal Bookmatch Silk - 12mm ST *

LARGE SIZES

LARGE SIZES



Marvel
CALACATTA EXTRA

Sizes	Thickness	Surface finish
120x120 cm - 47 1/4"x47 1/4"	± 9 mm	Polished Matte
120x240 cm - 47 1/4"x94 1/2"	± 9 mm	Polished
120x278 cm - 47 1/4"x109 1/2"	± 6 mm	Polished Matte
160x160 cm - 63"x63"	± 6 mm	Polished Matte
160x320 cm - 63"x126"	± 6 mm	Polished Matte

- ▼
- A20Y** Marvel Calacatta Extra 120x120 Matt
- AY2R** Marvel Calacatta Extra 120x120 Lappato
- AY2N** Marvel Calacatta Extra 120x240 Lappato
- A08T** Marvel Calacatta Extra 120x278 Matt
- A08M** Marvel Calacatta Extra 120x278 Lappato
- A054** Marvel Calacatta Extra 160x160RT Matt
- A051** Marvel Calacatta Extra 160x160RT Lappato
- A05Y** Marvel Calacatta Extra 160x320RT Matt
- A05U** Marvel Calacatta Extra 160x320RT Lappato

120x278 cm - 47 1/4"x109 1/2" ± 6 mm Polished



ENDLESS 1 **ENDLESS 2** **ENDLESS 3** **ENDLESS 4**

▼

A0UB Marvel Calacatta Extra 120x278 Endless Lp

120x278 cm - 47 1/4"x109 1/2" ± 6 mm Polished

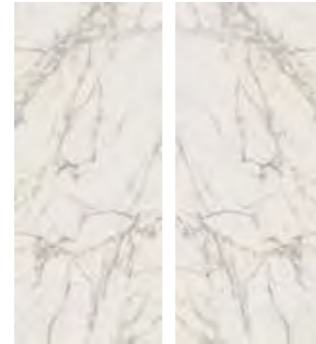

BOOKMATCH A **BOOKMATCH B**

▼

A0TJ Marvel Calacatta Extra 120x278 Bookm A Lp
A0TK Marvel Calacatta Extra 120x278 Bookm B Lp

atlasPLAN

162x324 cm - 63 3/4"x127 1/2" ± 6-12-20 mm Lappato Lux I Silk
NON-RECTIFIED

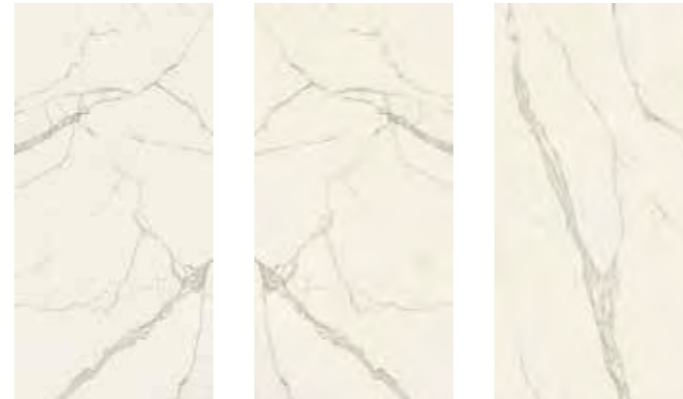

CALACATTA EXTRA A **CALACATTA EXTRA A BOOKMATCH** **CALACATTA EXTRA B**

- ▼
- AN1I** Calacatta Extra A Lap Lux - 6mm
- AN1H** Calacatta Extra A Silk - 6mm
- AN1J** Calacatta Extra A Lap Lux - 6mm ST *
- AN1G** Calacatta Extra A Silk - 6mm ST *
- AAVM** Calacatta Extra A Lap Lux - 12mm
- AA2S** Calacatta Extra A Silk - 12mm
- AAVD** Calacatta Extra A Lap Lux - 12mm ST *
- AA2T** Calacatta Extra A Silk - 12mm ST *
- AN1W** Calacatta Extra A Lap Lux - 20mm
- A0YC** Calacatta Extra A Silk - 20mm
- ▼
- AOAY** Calacatta Extra A Bookmatch Lap Lux - 6mm
- AOAV** Calacatta Extra A Bookmatch Silk - 6mm
- AOAZ** Calacatta Extra A Bookmatch Lap Lux - 6mm ST *
- AOAW** Calacatta Extra A Bookmatch Silk - 6mm ST *
- AAZW** Calacatta Extra A Bookmatch Lap Lux - 12mm
- AMJU** Calacatta Extra A Bookmatch Silk - 12mm
- AAZX** Calacatta Extra A Bookmatch Lap Lux - 12mm ST *
- AMJV** Calacatta Extra A Bookmatch Silk - 12mm ST *
- ▼
- A00H** Calacatta Extra B Lap Lux - 6mm
- A00J** Calacatta Extra B Silk - 6mm
- A00I** Calacatta Extra B Lap Lux - 6mm ST *
- A00K** Calacatta Extra B Silk - 6mm ST *
- AAVN** Calacatta Extra B Lap Lux - 12mm
- AA3F** Calacatta Extra B Silk - 12mm
- AAVF** Calacatta Extra B Lap Lux - 12mm ST *
- AA3G** Calacatta Extra B Silk - 12mm ST *
- A00E** Calacatta Extra B Lap Lux - 20mm



Marvel Pro
CREMA DELICATO

Sizes	Thickness	Surface finish
120x120 cm - 47 1/4"x47 1/4"	± 9 mm	Polished Matte
120x240 cm - 47 1/4"x94 1/2"	± 9 mm	Polished
120x278 cm - 47 1/4"x109 1/2"	± 6 mm	Polished Matte
160x160 cm - 63"x63"	± 6 mm	Polished
160x320 cm - 63"x126"	± 6 mm	Polished

- ▼
- A206** Marvel Crema Delicato 120x120 Matt
- AY2U** Marvel Crema Delicato 120x120 Lappato
- AY2Q** Marvel Crema Delicato 120x240 Lappato
- A2RU** Marvel Crema Delicato 120x278 Matt
- A080** Marvel Crema Delicato 120x278 Lappato
- A052** Marvel Crema Delicato 160x160RT Lappato
- A05W** Marvel Crema Delicato 160x320RT Lappato



Marvel Edge
ELEGANT SABLE

Sizes	Thickness	Surface finish
120x120 cm - 47 1/4"x47 1/4"	± 9 mm	Polished
120x240 cm - 47 1/4"x94 1/2"	± 9 mm	Polished
120x278 cm - 47 1/4"x109 1/2"	± 6 mm	Polished

- ▼
- AENK** Marvel Elegant Sable 120x120 Lappato
- AENR** Marvel Elegant Sable 120x240 Lappato
- A08L** Marvel Elegant Sable 120x278 Lappato

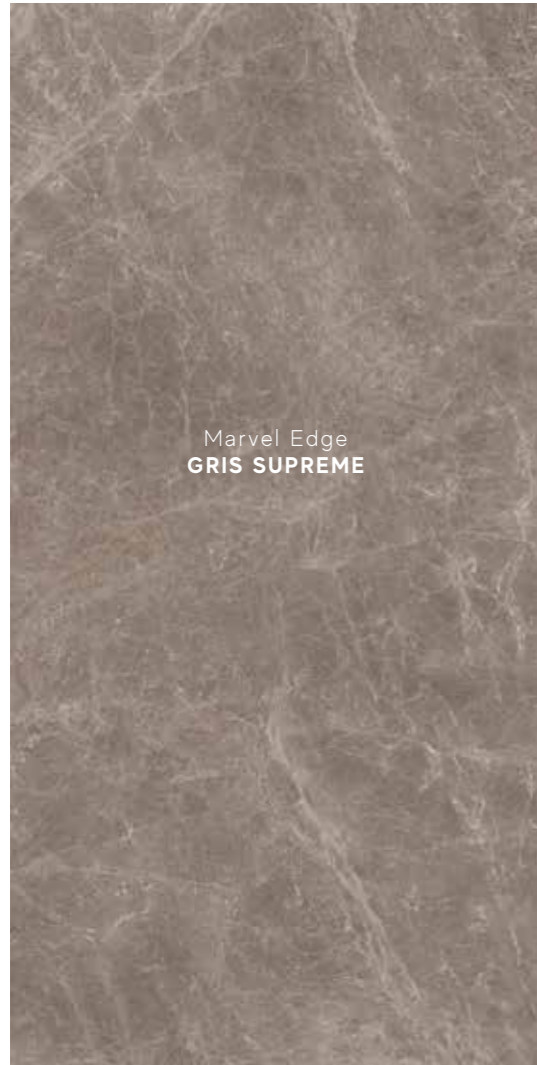

Marvel Edge
GRIS SUPREME

Sizes	Thickness	Surface finish
120x120 cm - 47 ¹ / ₄ "x47 ¹ / ₄ "	± 9 mm	Polished
120x240 cm - 47 ¹ / ₄ "x94 ¹ / ₂ "	± 9 mm	Polished

- ▼
AENN Marvel Gris Supreme 120x120 Lappato
AENS Marvel Gris Supreme 120x240 Lappato

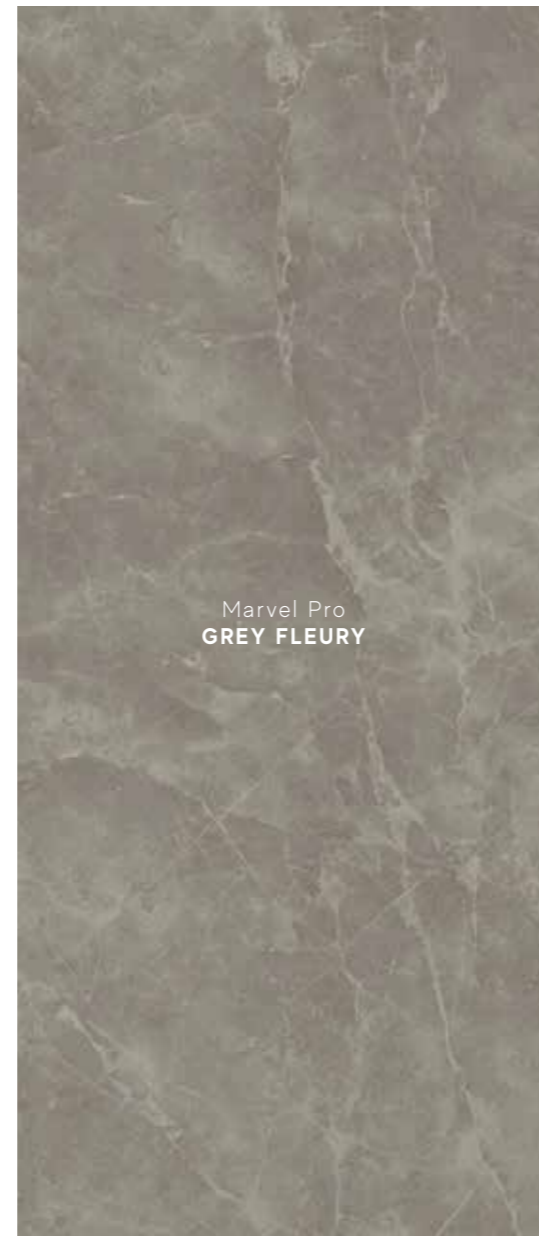

Marvel Pro
GREY FLEURY

Sizes	Thickness	Surface finish
120x120 cm - 47 ¹ / ₄ "x47 ¹ / ₄ "	± 9 mm	Polished I Matte
120x278 cm - 47 ¹ / ₄ "x109 ¹ / ₂ "	± 6 mm	Polished I Matte

- ▼
A205 Marvel Grey Fleury 120x120 Matt
A210 Marvel Grey Fleury 120x120 Lappato
A2RT Marvel Grey Fleury 120x278 Matt
A2RX Marvel Grey Fleury 120x278 Lappato



Marvel
GREY STONE

Sizes	Thickness	Surface finish
120x120 cm - 47 ¹ / ₄ "x47 ¹ / ₄ "	± 9 mm	Polished I Matte
120x240 cm - 47 ¹ / ₄ "x94 ¹ / ₂ "	± 9 mm	Polished
120x278 cm - 47 ¹ / ₄ "x109 ¹ / ₂ "	± 6 mm	Polished I Matte
162x324 cm - 63 ³ / ₄ "x127 ¹ / ₂ " > NON-RECTIFIED	± 6, 12, 20 mm	Silk

- ▼
AEQY Marvel Grey Stone 120x120 Matt
AY25 Marvel Grey Stone 120x120 Lappato
AY20 Marvel Grey Stone 120x240 Lappato
A2RP Marvel Grey Stone 120x278 Matt
AOQD Marvel Grey Stone 120x278 Lappato
atlas^{PLAN} 162x324 cm - 63³/₄"x127¹/₂"
 ▼
AN1U Grey Stone Silk - 6mm
AN1V Grey Stone Silk - 6mm ST *
AAVY Grey Stone Silk - 12mm
AAWA Grey Stone Silk - 12mm ST *
AN2B Grey Stone Silk - 20mm

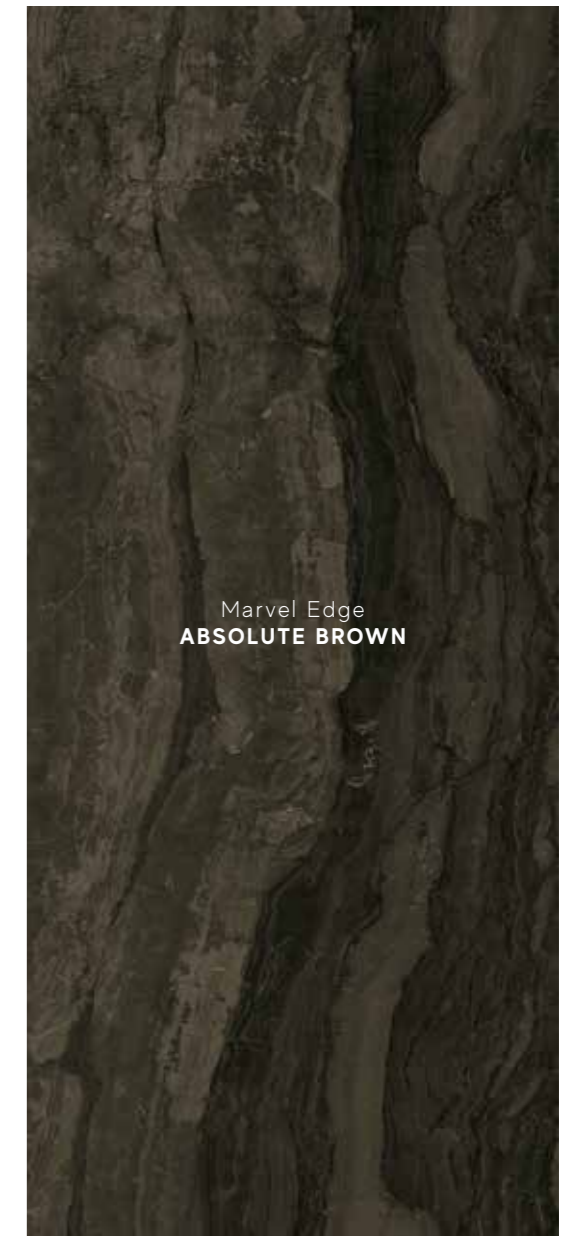

Marvel Edge
ABSOLUTE BROWN

Sizes	Thickness	Surface finish
120x120 cm - 47 ¹ / ₄ "x47 ¹ / ₄ "	± 9 mm	Polished
120x240 cm - 47 ¹ / ₄ "x94 ¹ / ₂ "	± 9 mm	Polished
120x278 cm - 47 ¹ / ₄ "x109 ¹ / ₂ "	± 6 mm	Polished

- ▼
AENO Marvel Absolute Brown 120x120 Lappato
AENT Marvel Absolute Brown 120x240 Lappato
AOQC Marvel Absolute Brown 120x278 Lappato

XL Large Sizes

Porcelain Tiles / Gres Porcellanato

MARBLE LOOK



Marvel Dream
GRIGIO INTENSO

Sizes	Thickness	Surface finish
120x120 cm - 47 1/4" x 47 1/4"	± 9 mm	Polished
120x240 cm - 47 1/4" x 94 1/2"	± 9 mm	Polished
120x278 cm - 47 1/4" x 109 1/2"	± 6 mm	Polished
162x324 cm - 63 3/4" x 127 1/2"	± 6 mm	Silk
> NON-RECTIFIED	± 12 mm	Lappato Lux

atlas PLAN 162x324 cm - 63 3/4" x 127 1/2"

- ▼
- AL70 Marvel Grigio Intenso 120x120 Lappato
- A03Q Marvel Grigio Intenso 120x240 Lappato
- A0SF Marvel Grigio Intenso 120x278 Lappato

- ▼
- A2YC Grigio Intenso Silk - 6mm
- AL7Y Grigio Intenso Silk - 6mm ST *
- A0Y8 Grigio Intenso Silk - 12mm
- A0Y9 Grigio Intenso Silk - 12mm ST *
- AL90 Grigio Intenso Lap Lux - 12mm
- AL91 Grigio Intenso Lap Lux - 12mm ST *



Marvel Dream
BLACK ATLANTIS

Sizes	Thickness	Surface finish
120x120 cm - 47 1/4" x 47 1/4"	± 9 mm	Polished Matte
120x240 cm - 47 1/4" x 94 1/2"	± 9 mm	Polished
120x278 cm - 47 1/4" x 109 1/2"	± 6 mm	Polished Matte

- ▼
- A20Z Marvel Black Atlantis 120x120 Matt
- AL7P Marvel Black Atlantis 120x120 Lappato
- A03R Marvel Black Atlantis 120x240 Lappato
- A2RQ Marvel Black Atlantis 120x278 Matt
- A0SG Marvel Black Atlantis 120x278 Lappato



Marvel Dream
ULTRAMARINE

Sizes	Thickness	Surface finish
120x278 cm - 47 1/4" x 109 1/2"	± 6 mm	Polished

- ▼
- AL2I Marvel Ultramarine 120x278 Lappato*

* Ultramarine 120x278 cm. Glazed Porcelain tiles

LARGE SIZES

LARGE SIZES



Marvel Stone
CREAM PRESTIGE

Sizes	Thickness	Surface finish
162x324 cm - 63 ³ / ₄ "x127 ¹ / ₂ " > NON-RECTIFIED	± 12 mm	Silk

atlas^{PLAN} 162x324 cm - 63³/₄"x127¹/₂"
 v
 AAVU Cream Prestige Silk - 12mm
 AAV6 Cream Prestige Silk - 12mm ST *

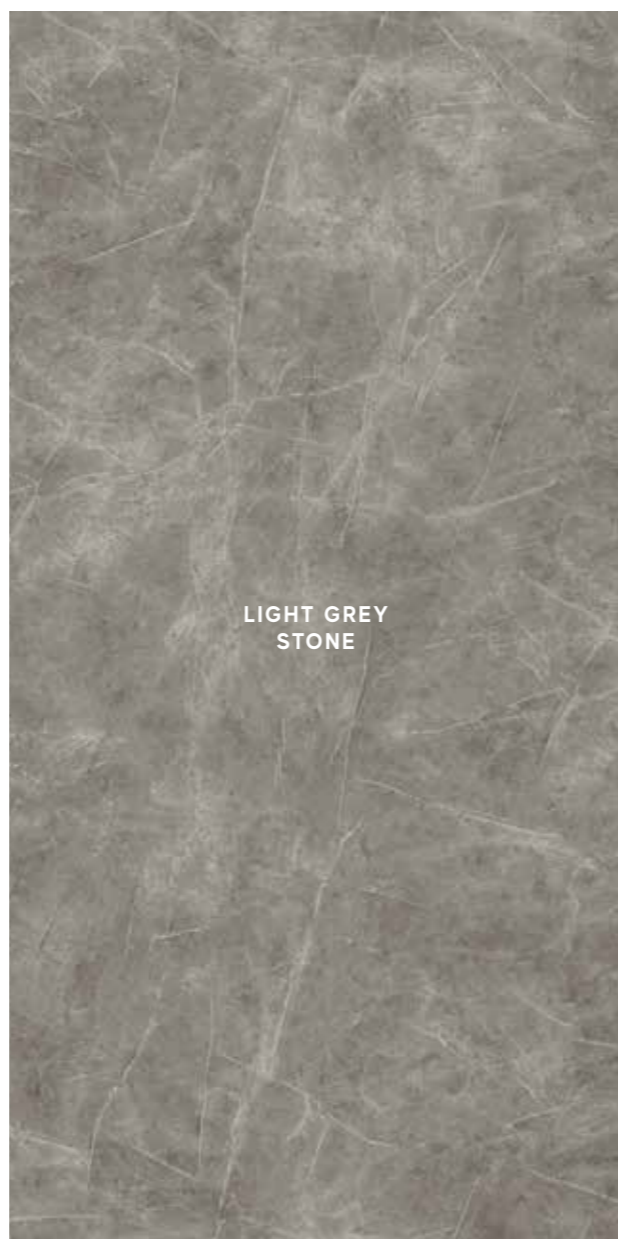

LIGHT GREY
STONE

Sizes	Thickness	Surface finish
162x324 cm - 63 ³ / ₄ "x127 ¹ / ₂ " > NON-RECTIFIED	± 12 mm	Silk

atlas^{PLAN} 162x324 cm - 63³/₄"x127¹/₂"
 v
 AMJ8 Light Grey Stone Silk - 12mm
 AMJ9 Light Grey Stone Silk - 12mm ST *



Marvel Gems
TERRAZZO BLACK

Sizes	Thickness	Surface finish
162x324 cm - 63 ³ / ₄ "x127 ¹ / ₂ " > NON-RECTIFIED	± 12 mm	Silk

atlas^{PLAN} 162x324 cm - 63³/₄"x127¹/₂"
 v
 AAV0 Terrazzo Black Silk - 12mm
 AAWC Terrazzo Black Silk - 12mm ST *

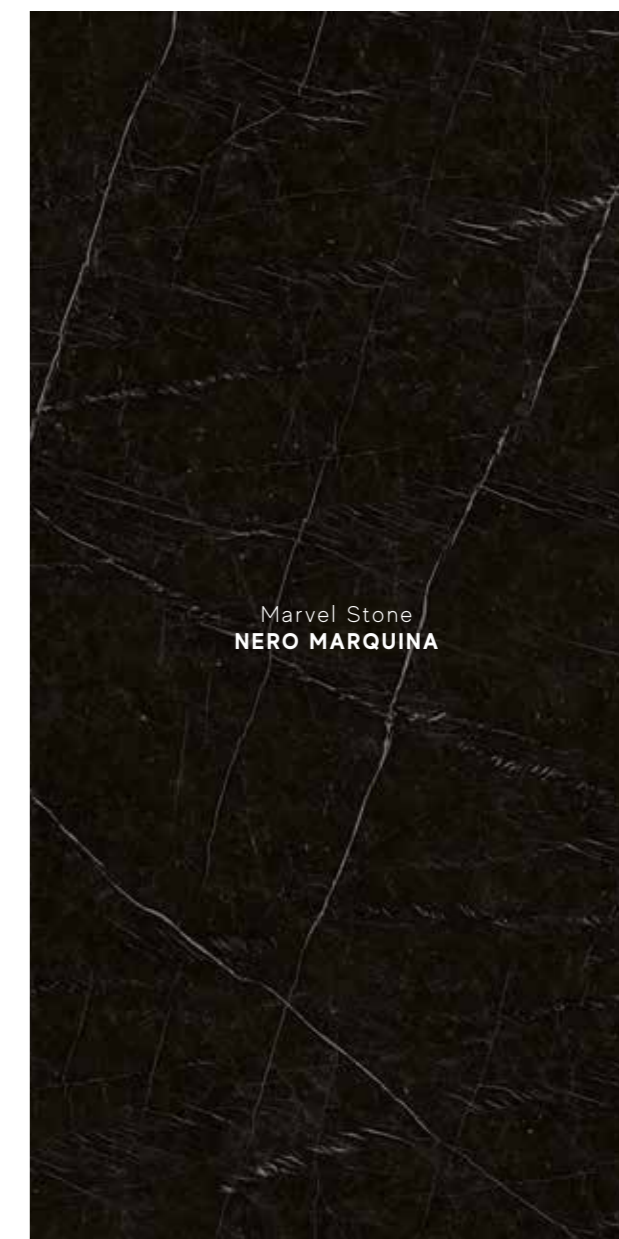

Marvel Stone
NERO MARQUINA

Sizes	Thickness	Surface finish
162x324 cm - 63 ³ / ₄ "x127 ¹ / ₂ " > NON-RECTIFIED	± 6, 12 mm ± 20 mm	Lappato Lux I Silk Silk

atlas^{PLAN} 162x324 cm - 63³/₄"x127¹/₂"
 v
 A07W Nero Marquina Silk - 6mm
 A07Y Nero Marquina Silk - 6mm ST *
 ANV9 Nero Marquina Lap Lux - 12mm
 ANWA Nero Marquina Lap Lux - 12mm ST *
 ANVJ Nero Marquina Silk - 12mm
 ANVK Nero Marquina Silk - 12mm ST *
 A2XT Nero Marquina Silk - 20mm

XL Large Sizes

Porcelain Tiles / Gres Porcellanato

MARBLE LOOK

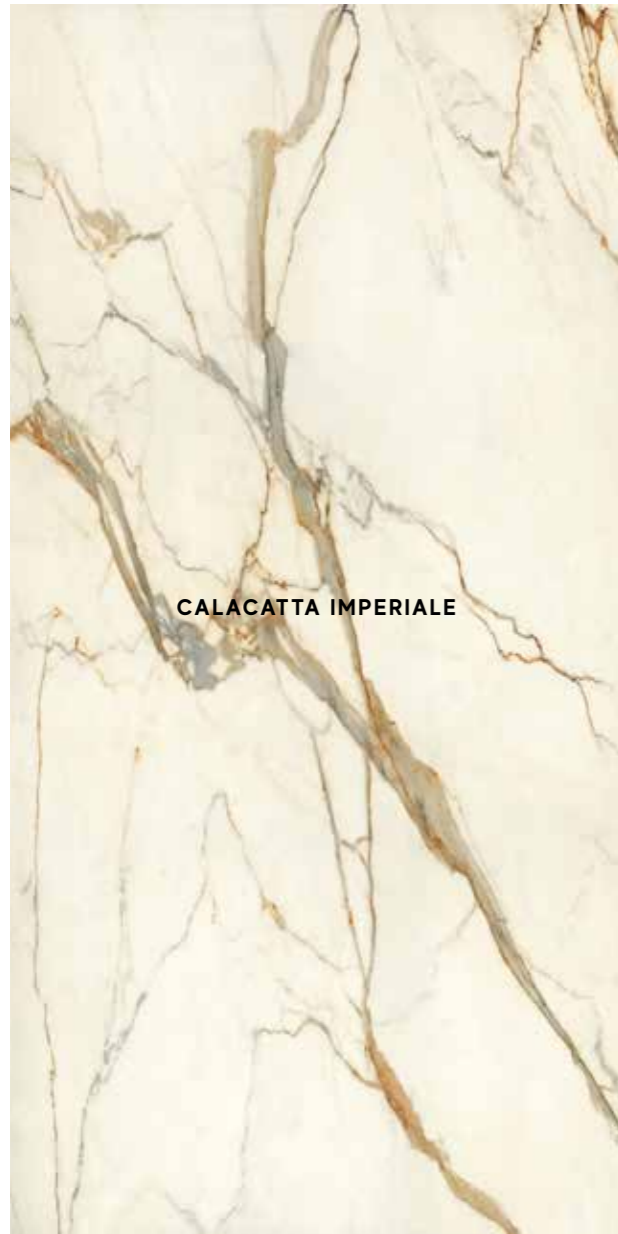

CALACATTA IMPERIALE

Sizes	Thickness	Surface finish
162x324 cm - 63 ³ / ₄ "x127 ¹ / ₂ "	± 6 mm	Silk
> NON-RECTIFIED	± 12, 20 mm	Lappato Lux I Silk

atlasPLAN 162x324 cm - 63³/₄"x127¹/₂"

- ▼
- A2YA Calacatta Imperiale Silk - 6mm
- A2YG Calacatta Imperiale Silk - 6mm ST *
- A0XJ Calacatta Imperiale Lap Lux - 12mm
- A0XI Calacatta Imperiale Lap Lux - 12mm ST *
- A1AE Calacatta Imperiale Lap Lux - 20mm NATURA VEIN
- A0XW Calacatta Imperiale Silk - 12mm
- A0XV Calacatta Imperiale Silk - 12mm ST *
- A16W Calacatta Imperiale Silk - 20mm NATURA VEIN

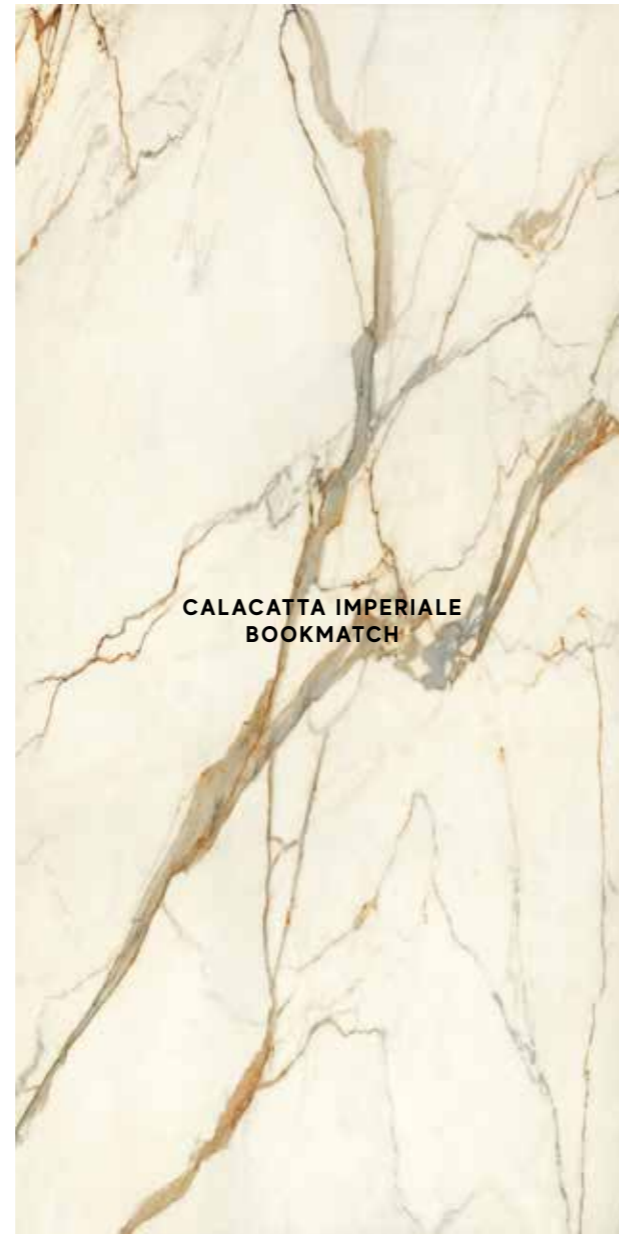

CALACATTA IMPERIALE
BOOKMATCH

Sizes	Thickness	Surface finish
162x324 cm - 63 ³ / ₄ "x127 ¹ / ₂ "	± 6 mm	Silk
> NON-RECTIFIED	± 12 mm	Lappato Lux I Silk

atlasPLAN 162x324 cm - 63³/₄"x127¹/₂"

- ▼
- A2YB Calacatta Imperiale Bookmatch Silk - 6mm
- A2YH Calacatta Imperiale Bookmatch Silk - 6mm ST *
- A0XU Calacatta Imperiale Bookmatch Lap Lux - 12mm
- A0XT Calacatta Imperiale Bookmatch Lap Lux - 12mm ST *
- A0XY Calacatta Imperiale Bookmatch Silk - 12mm
- A0XX Calacatta Imperiale Bookmatch Silk - 12mm ST *

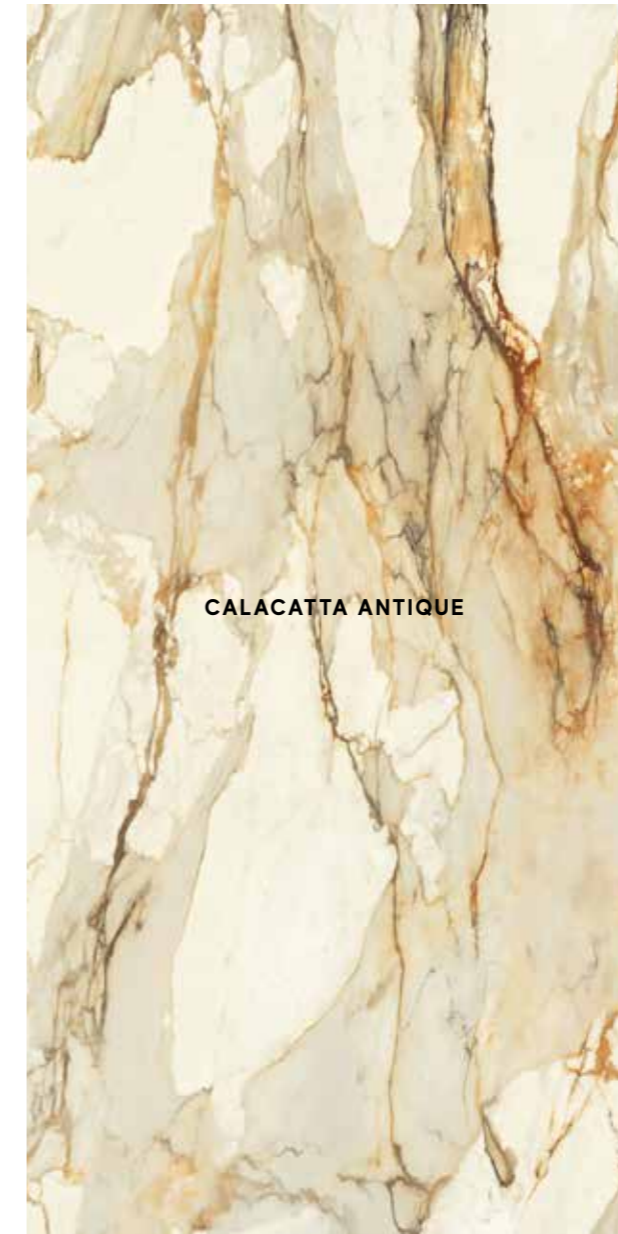

CALACATTA ANTIQUE

Sizes	Thickness	Surface finish
162x324 cm - 63 ³ / ₄ "x127 ¹ / ₂ "	± 12 mm	Lappato Lux
> NON-RECTIFIED		

atlasPLAN 162x324 cm - 63³/₄"x127¹/₂"

- ▼
- A0X0 Calacatta Antique Lap Lux - 12mm
- A0XZ Calacatta Antique Lap Lux - 12mm ST *



EMPERADOR DARK

Sizes	Thickness	Surface finish
162x324 cm - 63 ³ / ₄ "x127 ¹ / ₂ "	± 12 mm	Silk
> NON-RECTIFIED		

atlasPLAN 162x324 cm - 63³/₄"x127¹/₂"

- ▼
- ANVM Emperador Dark Silk - 12mm
- ANVN Emperador Dark Silk - 12mm ST *

LARGE SIZES

LARGE SIZES



Arkshade
WHITE

Sizes	Thickness	Surface finish
120x120 cm - 47 ¹ / ₄ "x47 ¹ / ₄ "	± 9 mm	Matte
120x240 cm - 47 ¹ / ₄ "x94 ¹ / ₂ "	± 9 mm	Matte

▼
AUG1 Arkshade White 120x120
AUGX Arkshade White 120x240

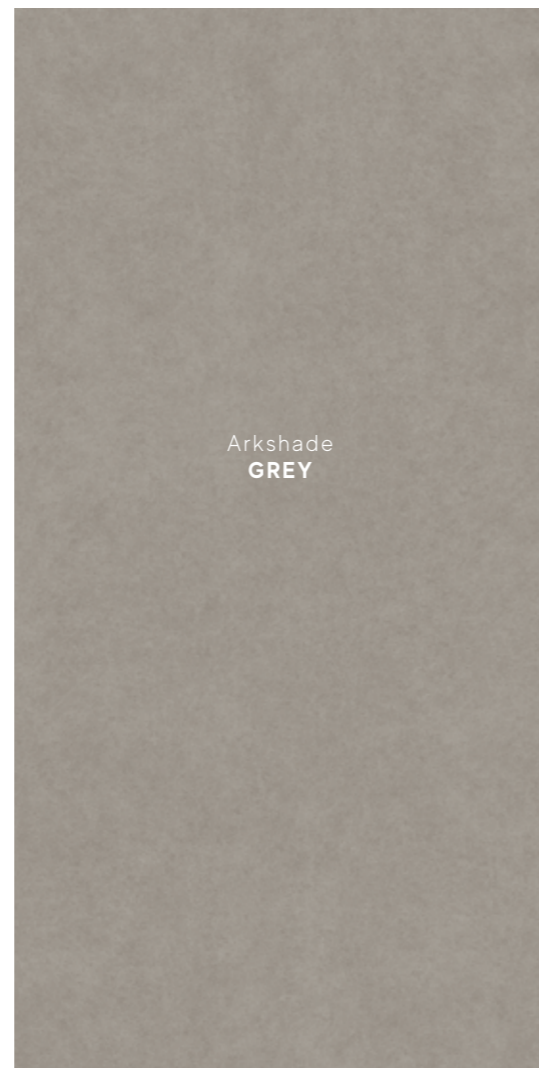

Arkshade
GREY

Sizes	Thickness	Surface finish
120x120 cm - 47 ¹ / ₄ "x47 ¹ / ₄ "	± 9 mm	Matte
120x240 cm - 47 ¹ / ₄ "x94 ¹ / ₂ "	± 9 mm	Matte

▼
AUG4 Arkshade Grey 120x120
AUG0 Arkshade Grey 120x240



Boost
WHITE

Sizes	Thickness	Surface finish
120x120 cm - 47 ¹ / ₄ "x47 ¹ / ₄ "	± 9 mm	Matte
120x240 cm - 47 ¹ / ₄ "x94 ¹ / ₂ "	± 9 mm	Matte
120x120 cm - 47 ¹ / ₄ "x47 ¹ / ₄ "	± 6 mm	Matte
120x278 cm - 47 ¹ / ₄ "x109 ¹ / ₂ "	± 6 mm	Matte
160x160 cm - 63"x63"	± 6 mm	Matte
160x320 cm - 63"x126"	± 6 mm	Matte
162x324 cm - 63 ³ / ₄ "x127 ¹ / ₂ "	± 6-12 mm	Matte

> **NON-RECTIFIED**

atlasPLAN 162x324 cm - 63³/₄"x127¹/₂"

▼
A2TK Boost White 120x120 6mm
AMGI Boost White 120x120
AMGD Boost White 120x240
A08D Boost White 120x278
A08E Boost White 160x160RT
A0SZ Boost White 160x320RT

▼
AN1L Boost White Matt - 6mm
AN1M Boost White Matt - 6mm ST *
ANVW Boost White Matt - 12mm
ANVX Boost White Matt - 12mm ST *



Boost
PEARL

Sizes	Thickness	Surface finish
120x120 cm - 47 ¹ / ₄ "x47 ¹ / ₄ "	± 9 mm	Matte
120x240 cm - 47 ¹ / ₄ "x94 ¹ / ₂ "	± 9 mm	Matte
120x120 cm - 47 ¹ / ₄ "x47 ¹ / ₄ "	± 6 mm	Matte
120x278 cm - 47 ¹ / ₄ "x109 ¹ / ₂ "	± 6 mm	Matte

- ▼
- A2TM Boost Pearl 120x120 6mm
- AMGJ Boost Pearl 120x120
- AMGE Boost Pearl 120x240
- A0BE Boost Pearl 120x278



Boost
GREY

Sizes	Thickness	Surface finish
120x120 cm - 47 ¹ / ₄ "x47 ¹ / ₄ "	± 9 mm	Matte
120x240 cm - 47 ¹ / ₄ "x94 ¹ / ₂ "	± 9 mm	Matte
120x120 cm - 47 ¹ / ₄ "x47 ¹ / ₄ "	± 6 mm	Matte
120x278 cm - 47 ¹ / ₄ "x109 ¹ / ₂ "	± 6 mm	Matte

- ▼
- A2TN Boost Grey 120x120 6mm
- AMGK Boost Grey 120x120
- AMGF Boost Grey 120x240
- A0BF Boost Grey 120x278



Boost
SMOKE

Sizes	Thickness	Surface finish
120x120 cm - 47 ¹ / ₄ "x47 ¹ / ₄ "	± 9 mm	Matte
120x240 cm - 47 ¹ / ₄ "x94 ¹ / ₂ "	± 9 mm	Matte
120x120 cm - 47 ¹ / ₄ "x47 ¹ / ₄ "	± 6 mm	Matte
120x278 cm - 47 ¹ / ₄ "x109 ¹ / ₂ "	± 6 mm	Matte
160x160 cm - 63"x63"	± 6 mm	Matte
160x320 cm - 63"x126"	± 6 mm	Matte
162x324 cm - 63 ³ / ₄ "x127 ¹ / ₂ "	± 6, 12, 20 mm	Matte
» NON-RECTIFIED		

atlasFLAN 162x324 cm - 63³/₄"x127¹/₂"

- ▼
- A2TO Boost Smoke 120x120 6mm
- AMGL Boost Smoke 120x120
- AMGG Boost Smoke 120x240
- A0BG Boost Smoke 120x278
- A0DF Boost Smoke 160x160RT
- A050 Boost Smoke 160x320RT
- ▼
- AN1N Boost Smoke Matt - 6mm
- AN1O Boost Smoke Matt - 6mm ST *
- ANVY Boost Smoke Matt - 12mm
- ANV0 Boost Smoke Matt - 12mm ST *
- A2XV Boost Smoke Matt - 20mm

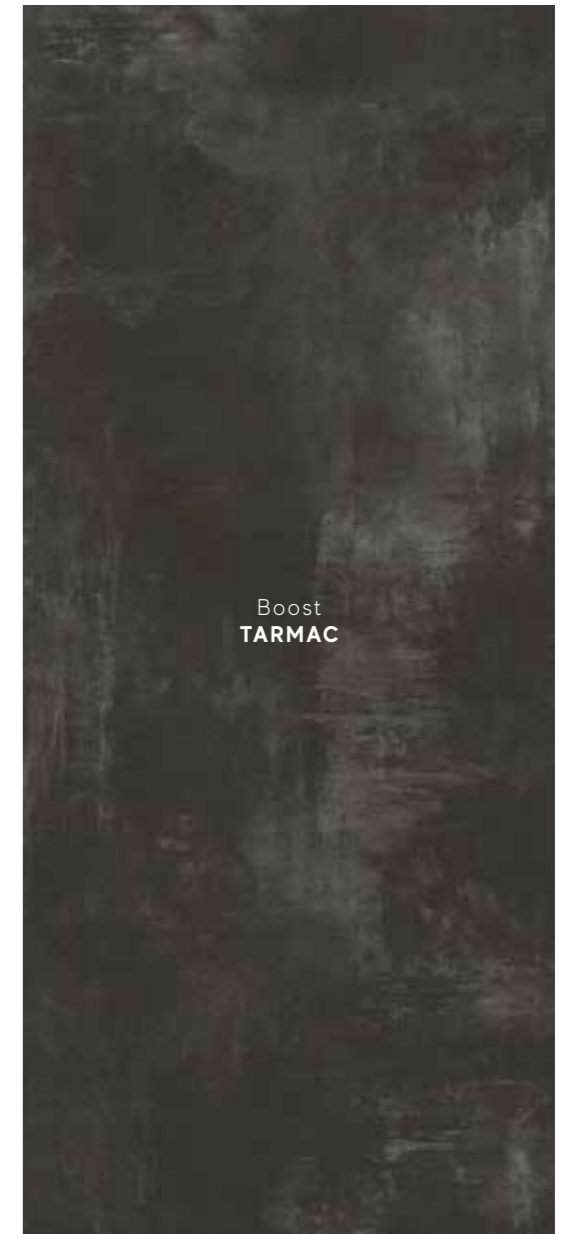

Boost
TARMAC

Sizes	Thickness	Surface finish
120x120 cm - 47 ¹ / ₄ "x47 ¹ / ₄ "	± 9 mm	Matte
120x240 cm - 47 ¹ / ₄ "x94 ¹ / ₂ "	± 9 mm	Matte
120x120 cm - 47 ¹ / ₄ "x47 ¹ / ₄ "	± 6 mm	Matte
120x278 cm - 47 ¹ / ₄ "x109 ¹ / ₂ "	± 6 mm	Matte

- ▼
- A2TP Boost Tarmac 120x120 6mm
- AMGM Boost Tarmac 120x120
- AMGH Boost Tarmac 120x240
- A0QB Boost Tarmac 120x278

XL Large Sizes

Porcelain Tiles / Gres Porcellanato

CONCRETE LOOK



Raw
WHITE

Sizes	Thickness	Surface finish
120x120 cm - 47 ¹ / ₄ "x47 ¹ / ₄ "	± 9 mm	Matte
120x278 cm - 47 ¹ / ₄ "x109 ¹ / ₂ "	± 6 mm	Matte

▼
APMK Raw White 120x120
APMW Raw White 120x278



Raw
PEARL

Sizes	Thickness	Surface finish
120x120 cm - 47 ¹ / ₄ "x47 ¹ / ₄ "	± 9 mm	Matte
120x278 cm - 47 ¹ / ₄ "x109 ¹ / ₂ "	± 6 mm	Matte

▼
APML Raw Pearl 120x120
APMX Raw Pearl 120x278



Raw
SAND

Sizes	Thickness	Surface finish
120x120 cm - 47 ¹ / ₄ "x47 ¹ / ₄ "	± 9 mm	Matte
120x278 cm - 47 ¹ / ₄ "x109 ¹ / ₂ "	± 6 mm	Matte

▼
APMU Raw Sand 120x120
APMY Raw Sand 120x278



Raw
MUD

Sizes	Thickness	Surface finish
120x120 cm - 47 ¹ / ₄ "x47 ¹ / ₄ "	± 9 mm	Matte
120x278 cm - 47 ¹ / ₄ "x109 ¹ / ₂ "	± 6 mm	Matte

▼
APMV Raw Mud 120x120
APMZ Raw Mud 120x278

LARGE SIZES

LARGE SIZES

XL Large Sizes

Porcelain Tiles / Gres Porcellanato

CONCRETE LOOK

STONE LOOK



Dwell
OFF WHITE

Sizes	Thickness	Surface finish
120x120 cm - 47 ¹ / ₄ "x47 ¹ / ₄ "	± 9 mm	Matte



Dwell
GREIGE

Sizes	Thickness	Surface finish
120x120 cm - 47 ¹ / ₄ "x47 ¹ / ₄ "	± 9 mm	Matte



Aix
BLANC

Sizes	Thickness	Surface finish
120x120 cm - 47 ¹ / ₄ "x47 ¹ / ₄ "	± 9 mm	Matte



Aix
CENDRE

Sizes	Thickness	Surface finish
120x120 cm - 47 ¹ / ₄ "x47 ¹ / ₄ "	± 9 mm	Matte



Dwell
GRAY

Sizes	Thickness	Surface finish
120x120 cm - 47 ¹ / ₄ "x47 ¹ / ₄ "	± 9 mm	Matte

▼
A1QJ Dwell Off White 120x120
A1QK Dwell Gray 120x120



Dwell
SMOKE

Sizes	Thickness	Surface finish
120x120 cm - 47 ¹ / ₄ "x47 ¹ / ₄ "	± 9 mm	Matte

▼
A1QL Dwell Greige 120x120
A1QM Dwell Smoke 120x120



Aix
BEIGE

Sizes	Thickness	Surface finish
120x120 cm - 47 ¹ / ₄ "x47 ¹ / ₄ "	± 9 mm	Matte

▼
A05N Aix Blanc 120x120
A05O Aix Beige 120x120



Aix
FUMÉE

Sizes	Thickness	Surface finish
120x120 cm - 47 ¹ / ₄ "x47 ¹ / ₄ "	± 9 mm	Matte

▼
A05Q Aix Cendre 120x120
A05R Aix Fumée 120x120



Kone
WHITE

Sizes	Thickness	Surface finish
120x120 cm - 47 ¹ / ₄ "x47 ¹ / ₄ "	± 9 mm	Matte
120x240 cm - 47 ¹ / ₄ "x94 ¹ / ₂ "	± 9 mm	Matte
120x278 cm - 47 ¹ / ₄ "x109 ¹ / ₂ "	± 6 mm	Matte

- ▼
- AULO** Kone White 120x120
- AULR** Kone White 120x240
- A0BR** Kone White 120x278



Kone
PEARL

Sizes	Thickness	Surface finish
120x120 cm - 47 ¹ / ₄ "x47 ¹ / ₄ "	± 9 mm	Matte
120x240 cm - 47 ¹ / ₄ "x94 ¹ / ₂ "	± 9 mm	Matte
120x278 cm - 47 ¹ / ₄ "x109 ¹ / ₂ "	± 6 mm	Matte

- ▼
- AULP** Kone Pearl 120x120
- AULS** Kone Pearl 120x240
- A0BQ** Kone Pearl 120x278



Kone
GREY

Sizes	Thickness	Surface finish
120x120 cm - 47 ¹ / ₄ "x47 ¹ / ₄ "	± 9 mm	Matte
120x240 cm - 47 ¹ / ₄ "x94 ¹ / ₂ "	± 9 mm	Matte
162x324 cm - 63 ³ / ₄ "x127 ¹ / ₂ "	± 6, 12 mm	Matte

> **NON-RECTIFIED**

- ▼
- AULQ** Kone Grey 120x120
- AULT** Kone Grey 120x240

atlasPLAN 162x324 cm - 63³/₄"x127¹/₂"

- ▼
- AN1R** Kone Grey Matt - 6mm
- AN1T** Kone Grey Matt - 6mm ST *
- ANXI** Kone Grey Matt - 12mm
- ANXH** Kone Grey Matt - 12mm ST *

XL Large Sizes

Porcelain Tiles / Gres Porcellanato

STONE LOOK



Marvel Stone
CLAUZETTO WHITE

Sizes	Thickness	Surface finish
120x120 cm - 47 ¹ / ₄ "x47 ¹ / ₄ "	± 9 mm	Matte
120x240 cm - 47 ¹ / ₄ "x94 ¹ / ₂ "	± 9 mm	Matte

- ▼
- AZT5 Marvel Clauzetto White 120x120 Matt
- AZT2 Marvel Clauzetto White 120x240 Matt

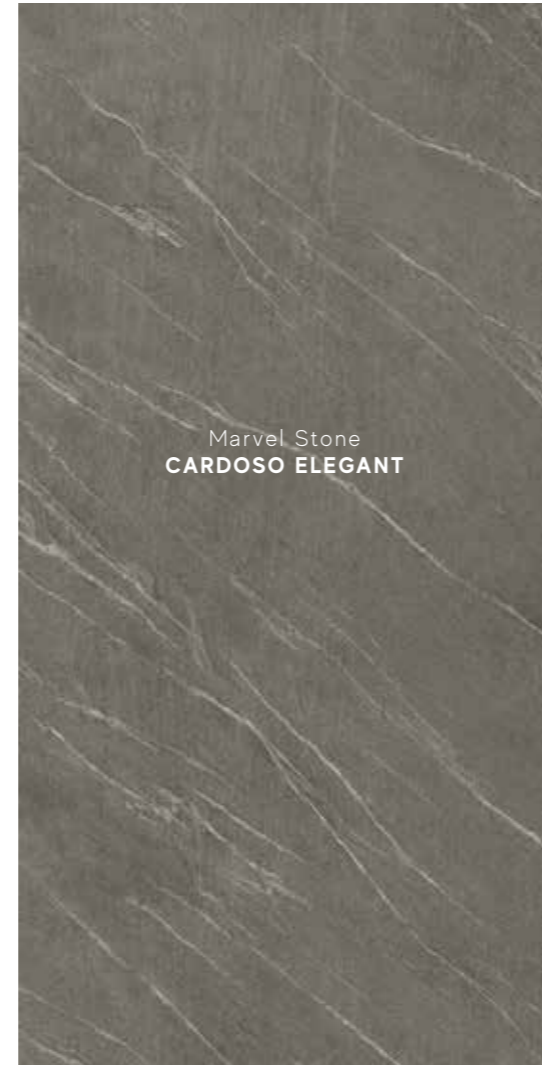

Marvel Stone
CARDOSO ELEGANT

Sizes	Thickness	Surface finish
120x120 cm - 47 ¹ / ₄ "x47 ¹ / ₄ "	± 9 mm	Matte
120x240 cm - 47 ¹ / ₄ "x94 ¹ / ₂ "	± 9 mm	Matte

- ▼
- AZT4 Marvel Cardoso Elegant 120x120
- AZT1 Marvel Cardoso Elegant 120x240



Marvel Stone
BASALTINA VOLCANO

Sizes	Thickness	Surface finish
120x120 cm - 47 ¹ / ₄ "x47 ¹ / ₄ "	± 9 mm	Matte
120x240 cm - 47 ¹ / ₄ "x94 ¹ / ₂ "	± 9 mm	Matte
162x324 cm - 63 ³ / ₄ "x127 ¹ / ₂ "	± 6, 12, 20 mm	Matte

> NON-RECTIFIED

- ▼
- AZT3 Marvel Basaltina Volcano 120x120 Matt
- AZT0 Marvel Basaltina Volcano 120x240 Matt
- AL9Y Basaltina Volcano Matt - 6mm
- AL9Z Basaltina Volcano Matt - 6mm ST *
- ANRI Basaltina Volcano Matt - 12mm
- ANVI Basaltina Volcano Matt - 12mm ST *
- A2XS Basaltina Volcano Matt - 20mm

Atlas PLAN 162x324 cm - 63³/₄"x127¹/₂"

LARGE SIZES

LARGE SIZES

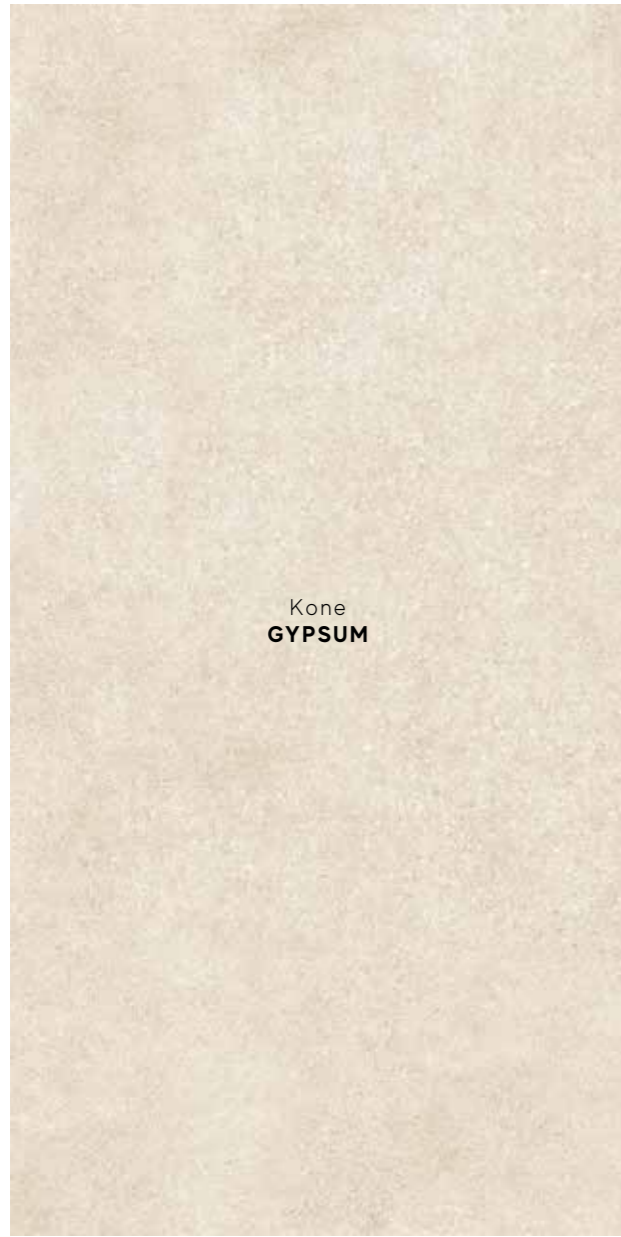

Kone
GYPSUM

Sizes	Thickness	Surface finish
162x324 cm - 63 ³ / ₄ "x127 ¹ / ₂ "	± 12 mm	Matte
> NON-RECTIFIED		

atlasPLAN 162x324 cm - 63³/₄"x127¹/₂"



- AMKC Kone Gypsum Matt - 12mm
- AMKD Kone Gypsum Matt - 12mm ST *

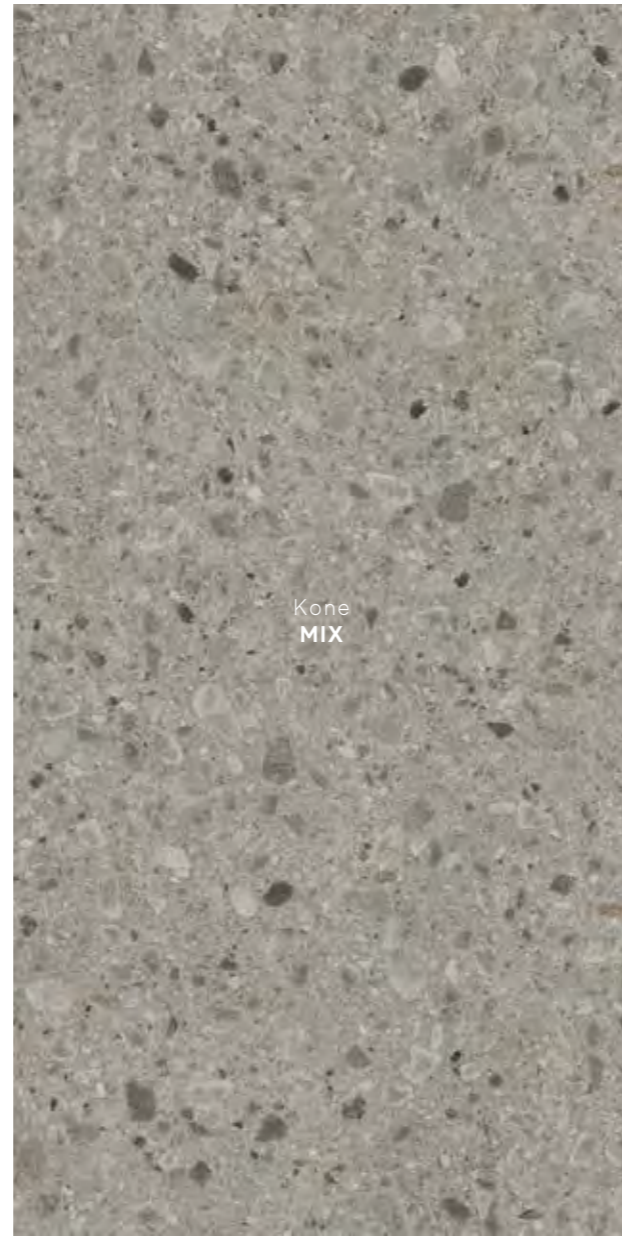

Kone
MIX

Sizes	Thickness	Surface finish
162x324 cm - 63 ³ / ₄ "x127 ¹ / ₂ "	± 6, 12 mm	Matte
> NON-RECTIFIED		

atlasPLAN 162x324 cm - 63³/₄"x127¹/₂"



- AN1P Kone Mix Matt - 6mm
- AN1Q Kone Mix Matt - 6mm ST *
- AMSQ Kone Mix Matt - 12mm
- AMSX Kone Mix Matt - 12mm ST *



Dolmen Pro
GRIGIO

Sizes	Thickness	Surface finish
162x324 cm - 63 ³ / ₄ "x127 ¹ / ₂ "	± 6, 12, 20 mm	Matte
> NON-RECTIFIED		

atlasPLAN 162x324 cm - 63³/₄"x127¹/₂"



- A2X7 Dolmen Pro Grigio Matt - 6mm
- A2YD Dolmen Pro Grigio Matt - 6mm ST *
- A0X9 Dolmen Pro Grigio Matt - 12mm
- A0X8 Dolmen Pro Grigio Matt - 12mm ST *
- A2XP Dolmen Pro Grigio Matt - 20mm

XL Large Sizes

Porcelain Tiles / Gres Porcellanato

CONCRETE LOOK



CONCRETE GREY

Sizes	Thickness	Surface finish
162x324 cm - 63 ³ / ₄ "x127 ¹ / ₂ "	± 12 mm	Silk
> NON-RECTIFIED		

atlasPLAN 162x324 cm - 63³/₄"x127¹/₂"

- ▼
- AAV Concrete Grey Silk - 12mm
- AAV7 Concrete Grey Silk - 12mm ST *



Mek
MEDIUM

Sizes	Thickness	Surface finish
162x324 cm - 63 ³ / ₄ "x127 ¹ / ₂ "	± 12 mm	Matte
> NON-RECTIFIED		

atlasPLAN 162x324 cm - 63³/₄"x127¹/₂"

- ▼
- ANVU Mek Medium Matt - 12mm
- ANVU Mek Medium Matt - 12mm ST *

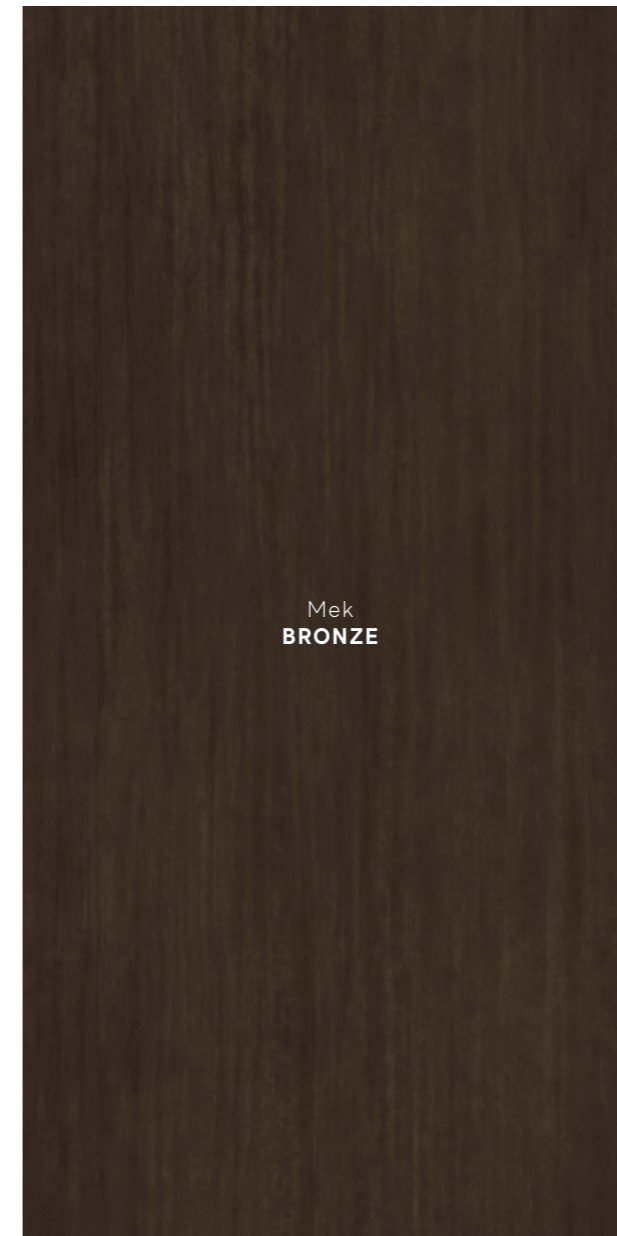

Mek
BRONZE

Sizes	Thickness	Surface finish
162x324 cm - 63 ³ / ₄ "x127 ¹ / ₂ "	± 12 mm	Matte
> NON-RECTIFIED		

atlasPLAN 162x324 cm - 63³/₄"x127¹/₂"

- ▼
- ANVS Mek Bronze Matt - 12mm
- ANVT Mek Bronze Matt - 12mm ST *



Mek
DARK

Sizes	Thickness	Surface finish
162x324 cm - 63 ³ / ₄ "x127 ¹ / ₂ "	± 12 mm	Matte
> NON-RECTIFIED		

atlasPLAN 162x324 cm - 63³/₄"x127¹/₂"

- ▼
- ANVQ Mek Dark Matt - 12mm
- ANVR Mek Dark Matt - 12mm ST *

LARGE SIZES

LARGE SIZES

XL Large Sizes

Porcelain Tiles / Gres Porcellanato

METAL LOOK

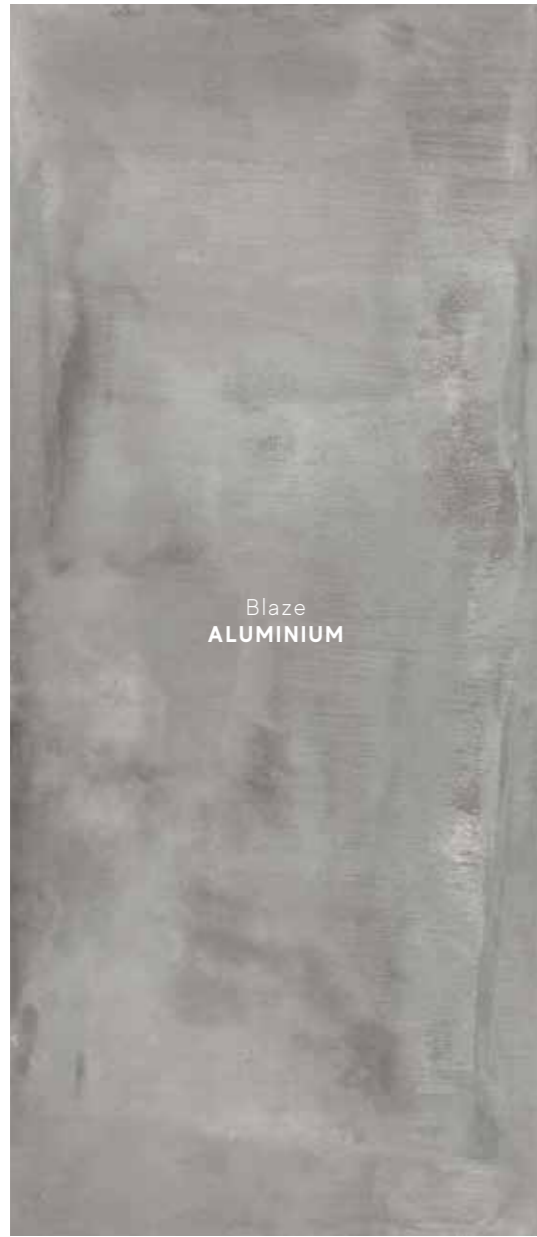

Blaze
ALUMINIUM

Sizes	Thickness	Surface finish
120x120 cm - 47 ¹ / ₄ "x47 ¹ / ₄ "	± 9 mm	Matte
120x278 cm - 47 ¹ / ₄ "x109 ¹ / ₂ "	± 6 mm	Matte

▼
APPK Blaze Aluminium 120x120
APO7 Blaze Aluminium 120x278

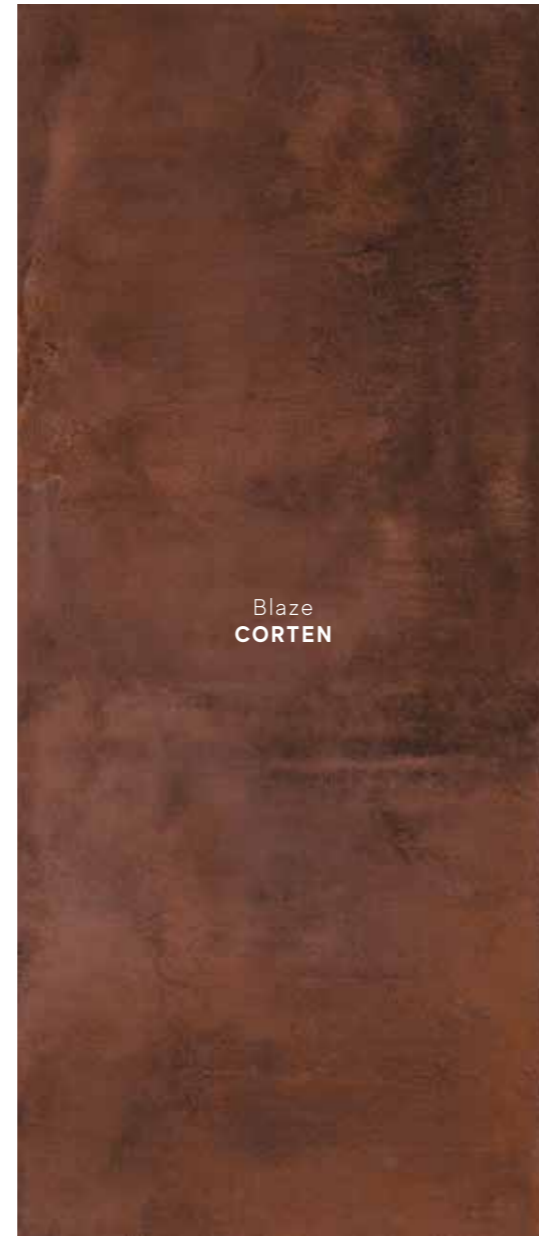

Blaze
CORTEN

Sizes	Thickness	Surface finish
120x120 cm - 47 ¹ / ₄ "x47 ¹ / ₄ "	± 9 mm	Matte
120x278 cm - 47 ¹ / ₄ "x109 ¹ / ₂ "	± 6 mm	Matte

▼
APPW Blaze Corten 120x120
APO8 Blaze Corten 120x278



Blaze
IRON

Sizes	Thickness	Surface finish
120x120 cm - 47 ¹ / ₄ "x47 ¹ / ₄ "	± 9 mm	Matte
120x278 cm - 47 ¹ / ₄ "x109 ¹ / ₂ "	± 6 mm	Matte

▼
APPX Blaze Iron 120x120
APO9 Blaze Iron 120x278

XL Large Sizes

Porcelain Tiles / Gres Porcellanato



ABSOLUTE WHITE

Sizes	Thickness	Surface finish
162x324 cm - 63 ³ / ₄ "x127 ¹ / ₂ "	± 6 mm	Matte
> NON-RECTIFIED	± 12, 20 mm	Silk

atlas^{PLAN} 162x324 cm - 63³/₄"x127¹/₂"

- ▼
- A07X Absolute White Matt - 6mm
- A07Z Absolute White Matt - 6mm ST *
- AMJ6 Absolute White Silk - 12mm
- AMJ7 Absolute White Silk - 12mm ST *
- A00B Absolute White Silk - 20mm

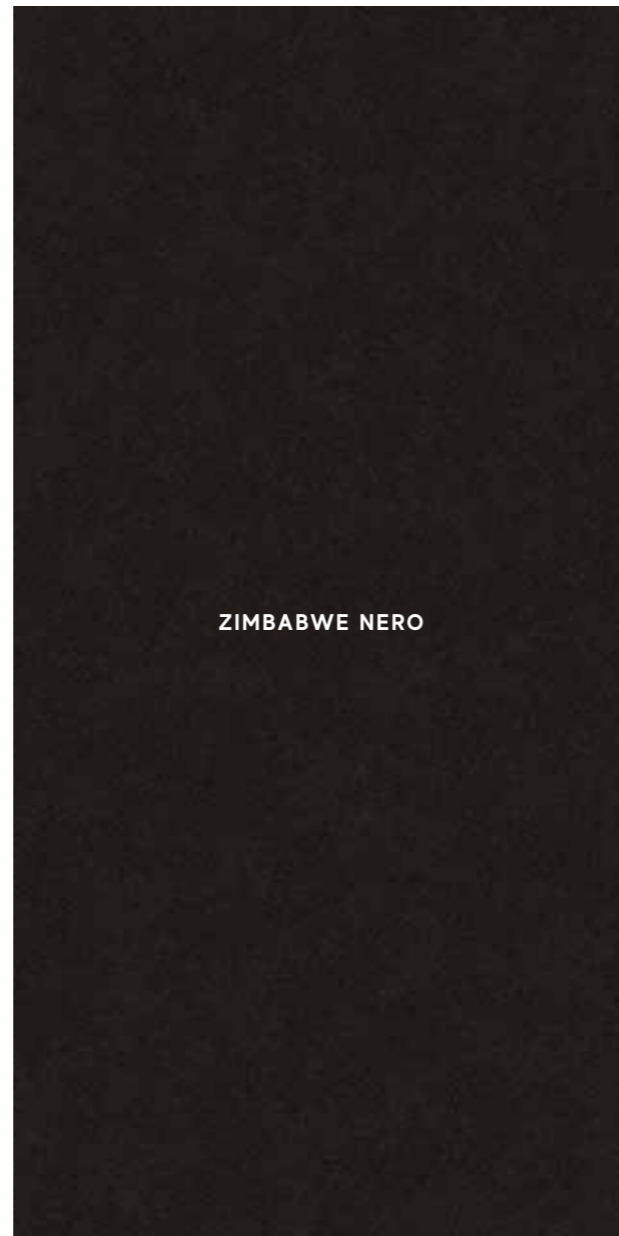

ZIMBABWE NERO

Sizes	Thickness	Surface finish
162x324 cm - 63 ³ / ₄ "x127 ¹ / ₂ "	± 6, 12, 20 mm	Matte
> NON-RECTIFIED		

atlas^{PLAN} 162x324 cm - 63³/₄"x127¹/₂"

- ▼
- A2X8 Nero Zimbabwe Matt - 6mm
- A2YE Nero Zimbabwe Matt - 6mm ST *
- A0Y4 Nero Zimbabwe Matt - 12mm
- A0Y3 Nero Zimbabwe Matt - 12mm ST *
- A2XQ Nero Zimbabwe Matt - 20mm

XL Large Sizes

Destinations of Use / Destinazione d'uso

Heavy commercial, medium commercial and residential. Commerciale pesante, commerciale medio e residenziale.			
ARKSHADE	Matte	± 9 mm	H
AIX	Matte	± 9 mm	H
BLAZE	Matte	± 6 mm	M
	Matte	± 9 mm	H
BOOST	Matte	± 6 mm	M
	Matte	± 9 mm	H
DWELL	Matte	± 9 mm	H
KONE	Matte	± 6 mm	M
	Matte	± 9 mm	H
MARVEL	Polished	± 6/9 mm	M
	Matte	± 6 mm	M
	Matte	± 9 mm	H
MARVEL DREAM	Polished	± 6/9 mm	M
	Matte	± 6 mm	M
	Matte	± 9 mm	H
MARVEL EDGE	Polished	± 6/9 mm	M
	Polished	± 6/9 mm	M
MARVEL PRO	Matte	± 6 mm	M
	Matte	± 9 mm	H
	Polished	± 6/9 mm	M
MARVEL STONE (Marble look)	Matte	± 6 mm	M
	Matte	± 9 mm	H
MARVEL STONE (Stone look)	Matte	± 9 mm	H
	Matte	± 6 mm	M
RAW	Matte	± 6 mm	M
	Matte	± 9 mm	H



Heavy commercial / Commerciali pesanti

Malls, airports, places of worship, schools, museums, squares, hospitals, hotels - foyers, undergrounds, train stations, etc.

Mall, aeroporti, luoghi di culto, scuole, musei, piazze, ospedali, hotel - hall di ingresso, metropolitane, stazioni ferroviarie, ecc...



Medium commercial / Commerciali medi

Restaurants, offices, shops, public restrooms, public offices, hotels except for foyers, business lounges, etc. with the exception of mandatory passageways and areas subject to the transit of trolleys with hard wheels or highly concentrated loads.

Ristoranti, uffici, negozi, bagni pubblici, uffici pubblici, hotel - ad esclusione delle hall di ingresso, business lounge, etc. a esclusione di passaggi obbligati e zone soggetto a transito di carrelli con ruote dure ovvero elevati carichi concentrati.



Residential / Residenziali

Bedrooms, living rooms, studies, private kitchens, private bathrooms, etc..

Camere da letto, soggiorni, studi, cucine private, bagni privati...

* WITH FIBERGLASS MESH | VERSIONE STUOIATA | Version à nattes | Ausführung mit Glasfasermatte | Versión con malla | С упрочнением из стекловолоконна

Outdoor*design*

OUTDOOR PAVING AND WET AREAS

COLOURED BODY PORCELAIN TILES - RECTIFIED MONOCALIBER
GRES PORCELLANATO COLORATO IN MASSA - RETTIFICATO MONOCALIBRO



atlas concorde

Porcelain Tiles / Gres Porcellanato

TEXTURED - GRIP SURFACE / SUPERFICIE STRUTTURATA - GRIP

STONE LOOK
± 9 mm - 9,5 mm



Sizes	Thickness	Surface finish
37,5x75 cm - 14 ³ / ₄ "x29 ¹ / ₂ " > Aix, Dolmen Pro, Klif	± 9 mm	Grip
30x60 cm - 11 ³ / ₄ "x23 ⁵ / ₈ " > Brave, Kone, Trust	± 9 mm	Grip
30x60 cm - 11 ³ / ₄ "x23 ⁵ / ₈ " > Marvel Stone	± 9 mm	Textured
22,5x45,3 cm - 8 ⁷ / ₈ "x17 ³ / ₄ " > Not Rectified Aix, Dolmen Pro	± 9 mm	Textured
22,5x22,5 cm - 8 ⁷ / ₈ "x8 ⁷ / ₈ " > Not Rectified Aix, Dolmen Pro	± 9 mm	Textured

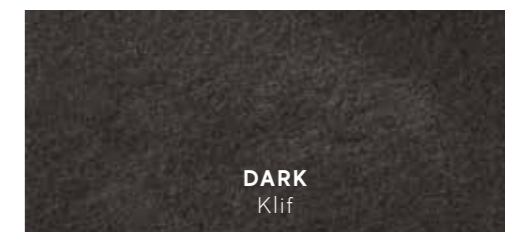
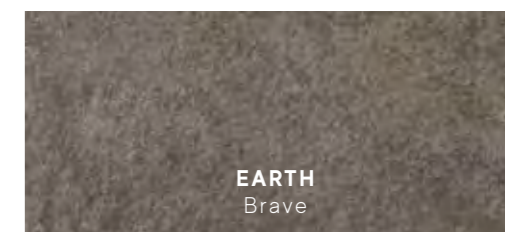
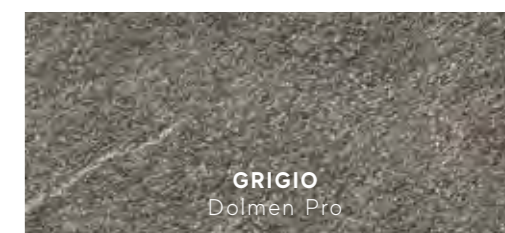
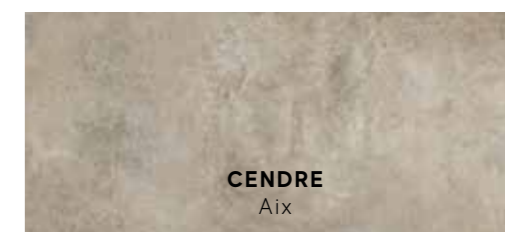
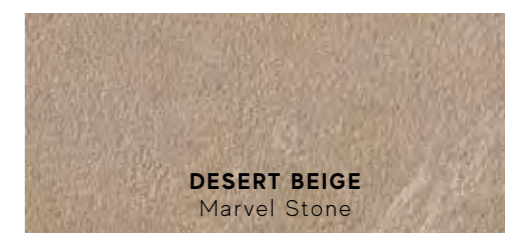
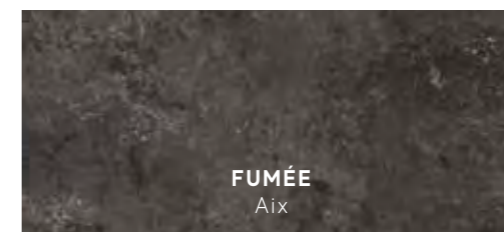
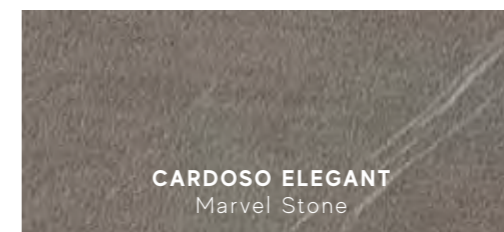
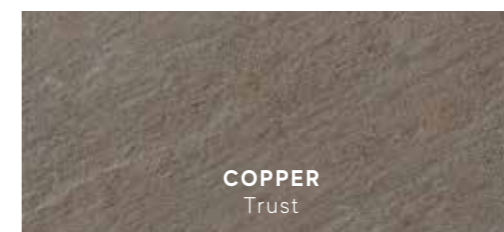
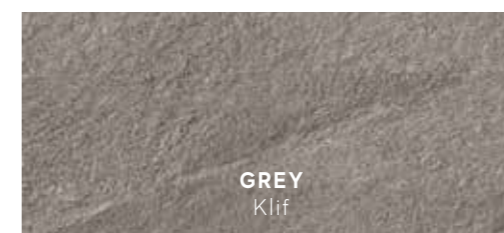
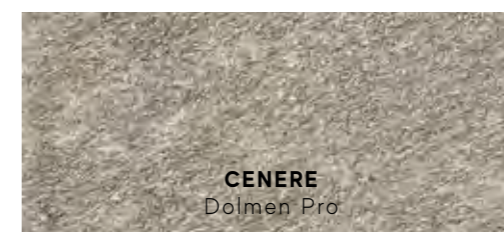
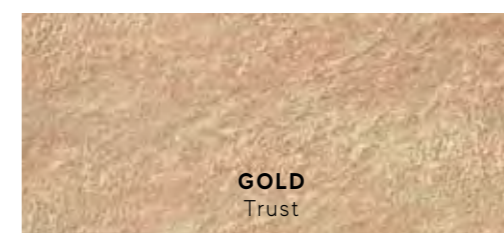
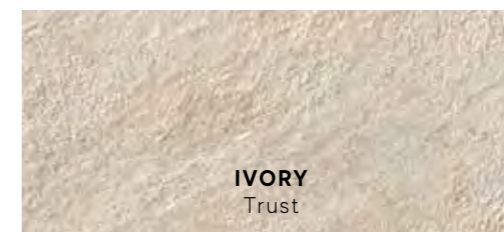
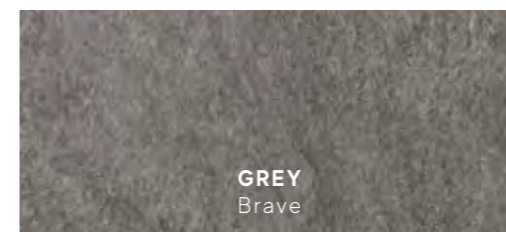
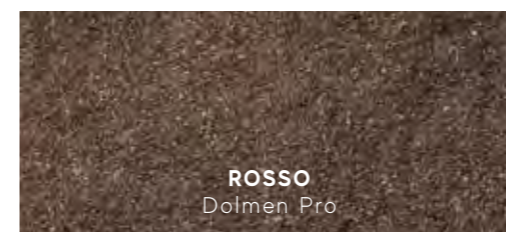
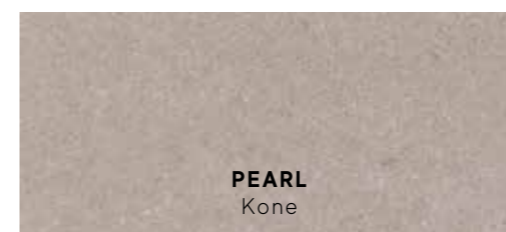
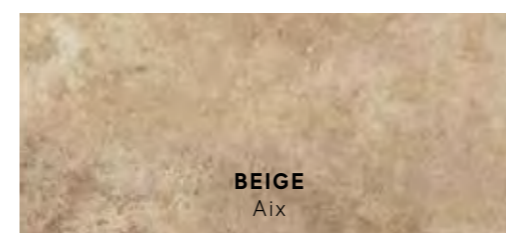
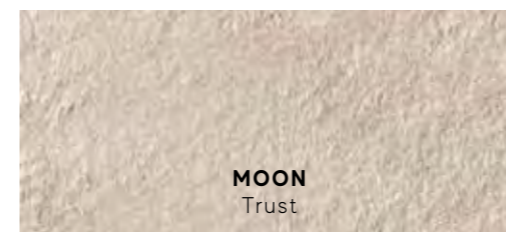
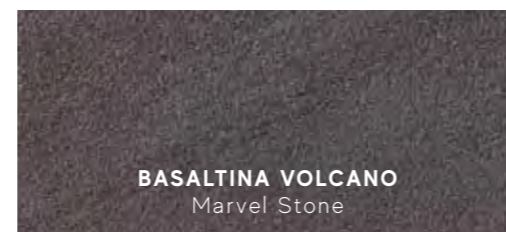
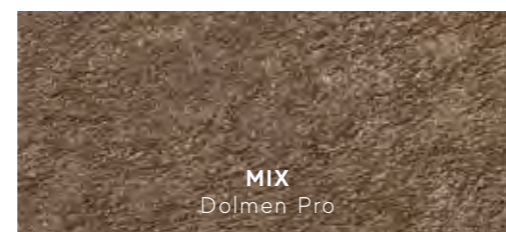
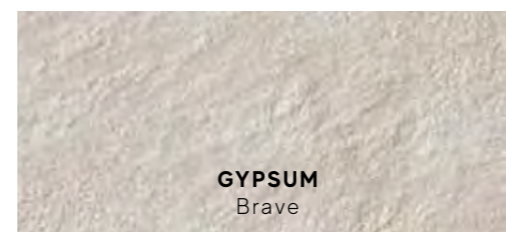
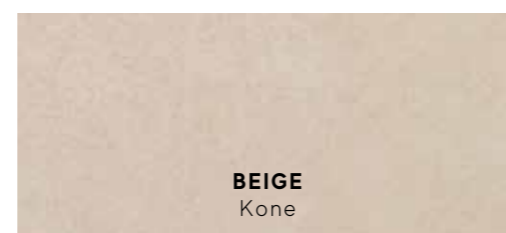

R11 A+B	R11 A+B+C	R12 A+B+C
KONE	AIX DOLMEN PRO KLIF MARVEL STONE	BRAVE TRUST

Porcelain Tiles / Gres Porcellanato

OUTDOOR PAVING / PAVIMENTI DA ESTERNO

STONE LOOK
± 20 mm - 30 mm



Sizes	Thickness	Surface finish
120x120 cm - 47 ¹ / ₄ "x47 ¹ / ₄ " > Aix, Brave, Trust	± 20 mm	Textured
60x120 cm - 23 ⁵ / ₈ "x47 ¹ / ₄ " > Brave, Dolmen Pro, Marvel Stone, Trust	± 20 mm	Textured
90x90 cm - 35 ³ / ₈ "x35 ³ / ₈ " > Echo, Klif	± 20 mm	Textured
60x90 cm - 23 ⁵ / ₈ "x35 ³ / ₈ " > Aix	± 20 mm	Textured
45x90 cm - 17 ³ / ₄ "x35 ³ / ₈ " > Brave, Klif, Kone, Trust	± 20 mm	Textured
60x60 cm - 23 ⁵ / ₈ "x23 ⁵ / ₈ " > Aix, Brave, Klif, Kone, Seastone, Sunrock, Trust	± 20 mm	Textured
60x60 cm - 23 ⁵ / ₈ "x23 ⁵ / ₈ " > Trust	± 30 mm	Textured
30x60 cm - 11 ³ / ₄ "x23 ⁵ / ₈ " > Brave, Trust	± 20 mm	Textured
22,5x45,4 cm - 8 ⁷ / ₈ "x17 ³ / ₄ " > Not Rectified Aix, Dolmen Pro	± 20 mm	Textured
22,5x22,5 cm - 8 ⁷ / ₈ "x8 ⁷ / ₈ " > Not Rectified Aix, Dolmen Pro	± 20 mm	Textured



R11
A+B+C

AIX
BRAVE
DOLMEN PRO
ECHO
KLIF
KONE
MARVEL STONE
SEASTONE
SUNROCK
TRUST

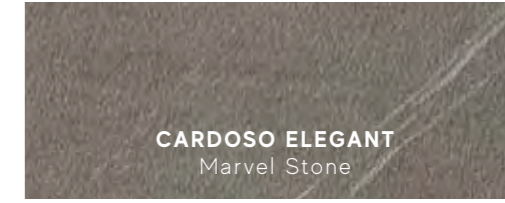
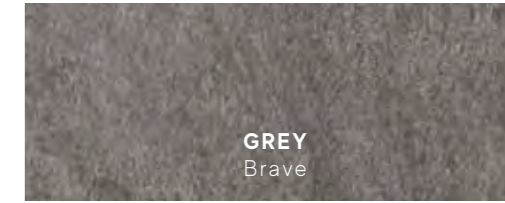
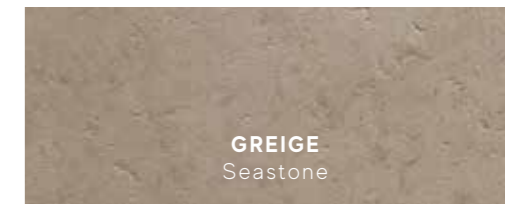
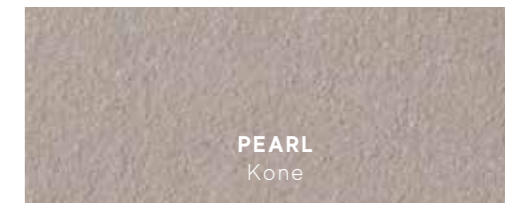
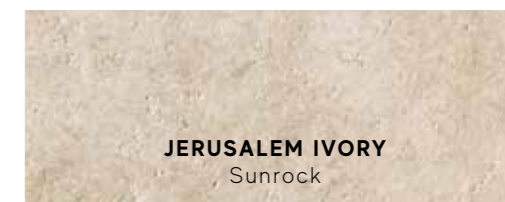
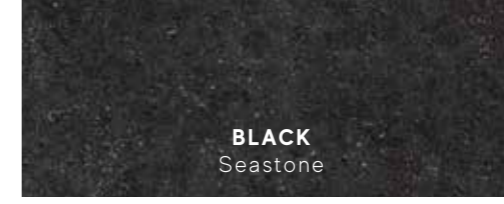
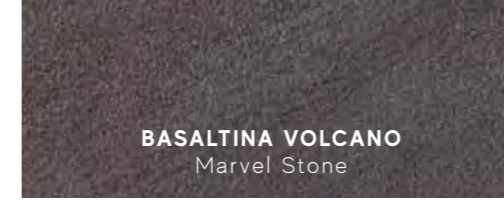
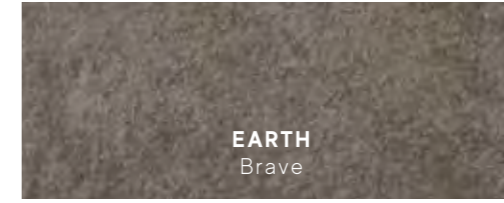
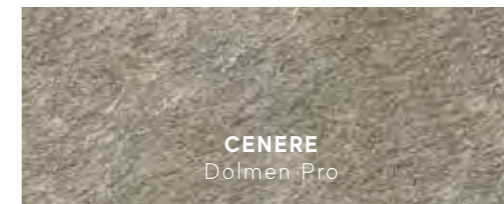
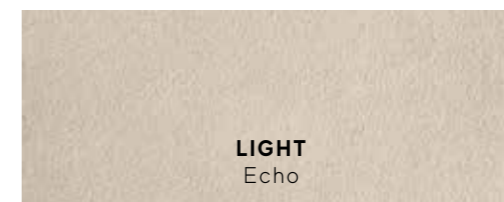
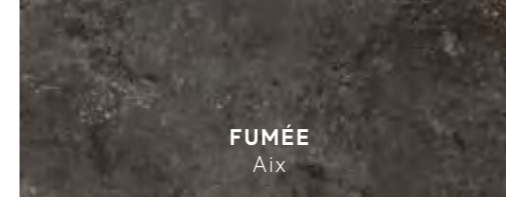
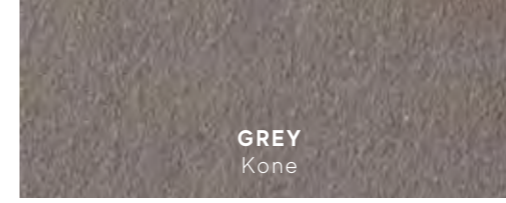
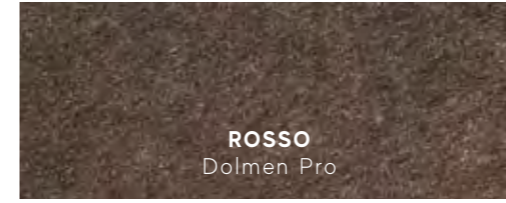
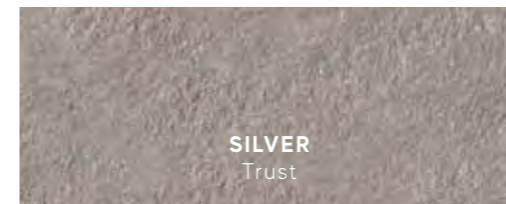
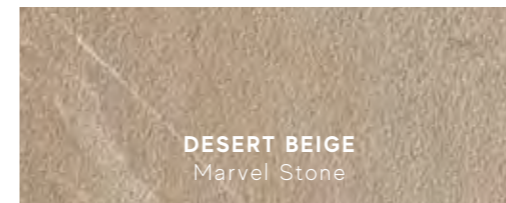
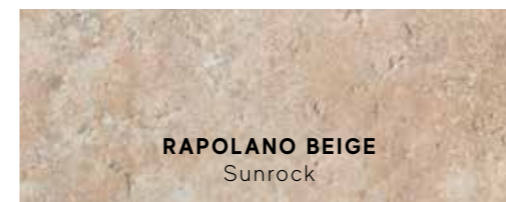
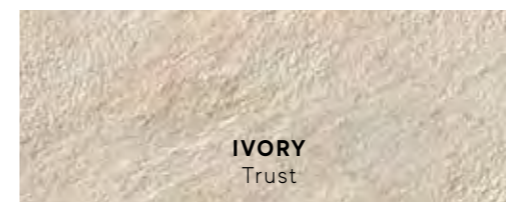
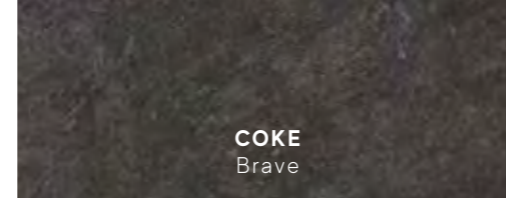
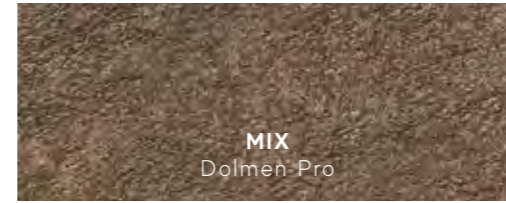
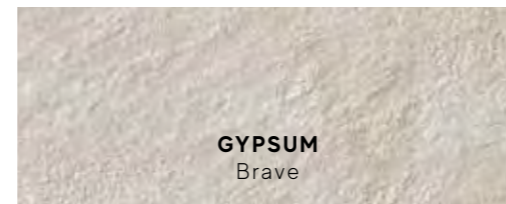
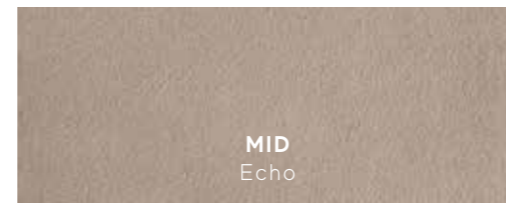
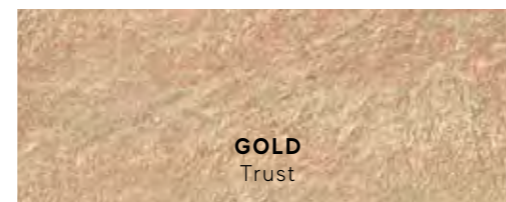

Porcelain Tiles / Gres Porcellanato

TEXTURED - GRIP SURFACE / SUPERFICIE STRUTTURATA - GRIP

WOOD LOOK ± 9 mm - 9,5 mm



Sizes	Thickness	Surface finish
18,5x150 cm - 7 ¹ / ₄ "x59" > Exence	± 9 mm	Grip
20x120 cm - 7 ⁷ / ₈ "x47 ¹ / ₄ " > Nash	± 9 mm	Grip
22,5x90 cm - 8 ⁷ / ₈ "x35 ³ / ₈ " > Axi, Etic	± 9,5 mm	Textured
22,5x90 cm - 8 ⁷ / ₈ "x35 ³ / ₈ " > Etic Pro	± 9 mm	Grip
15x90 cm - 5 ⁷ / ₈ "x35 ³ / ₈ " > Arbor	± 9 mm	Grip

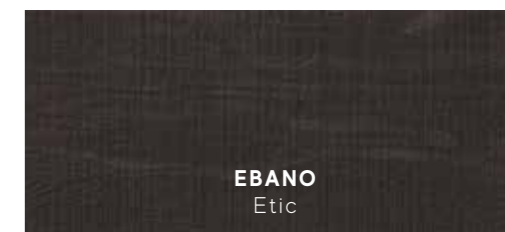
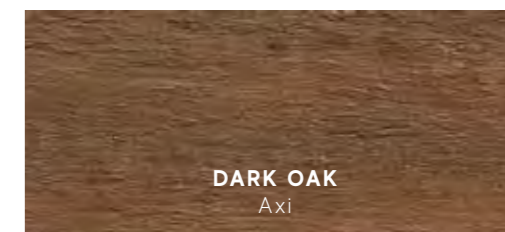
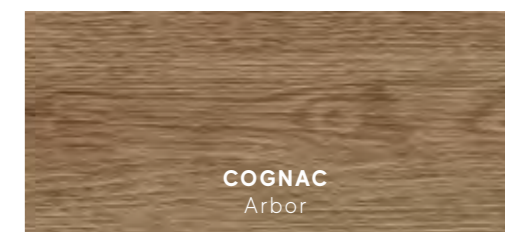
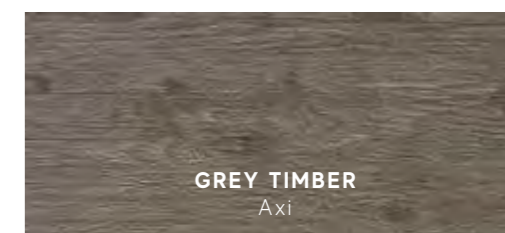
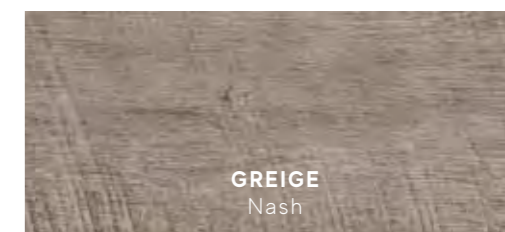
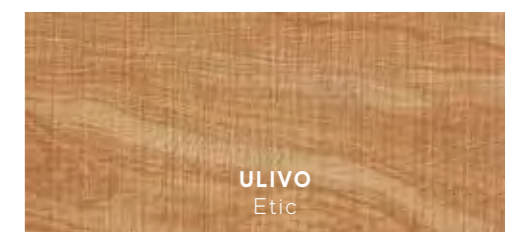
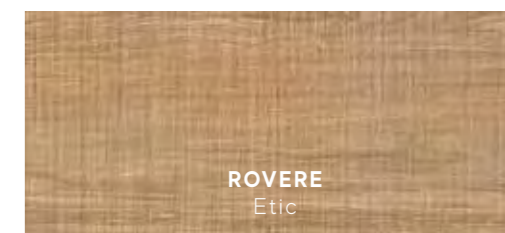
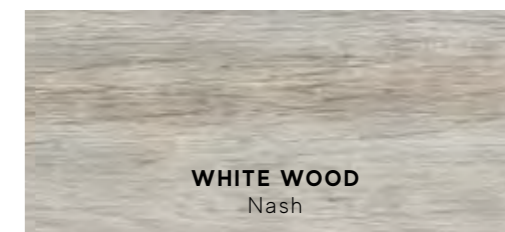
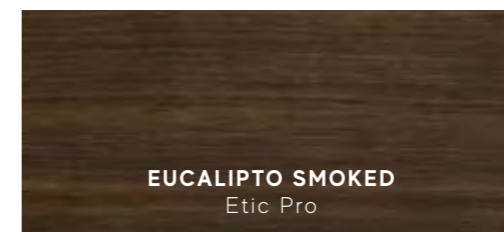
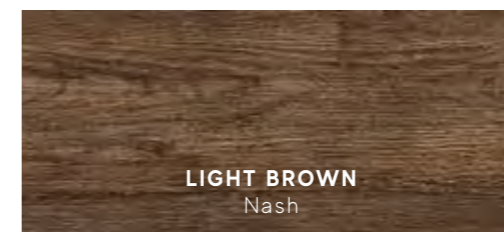
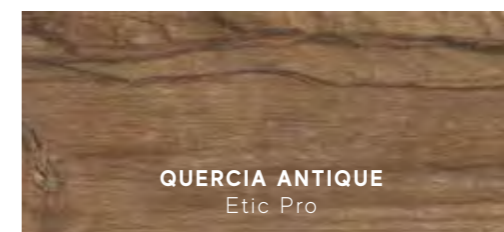
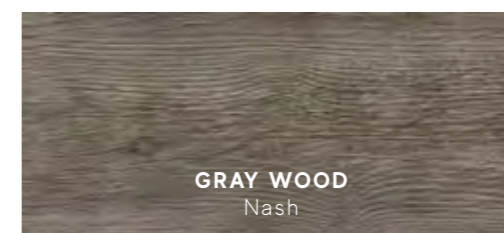
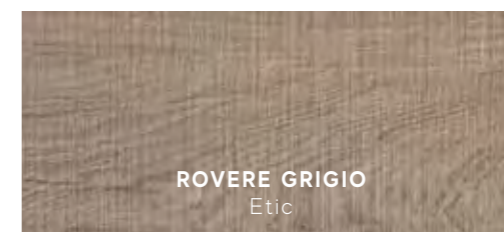
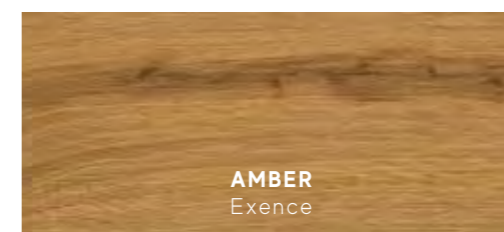
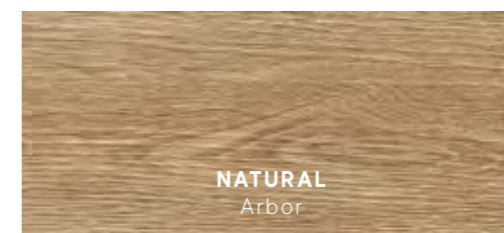
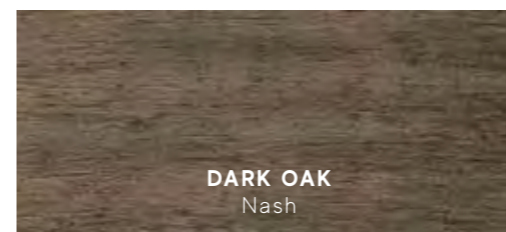
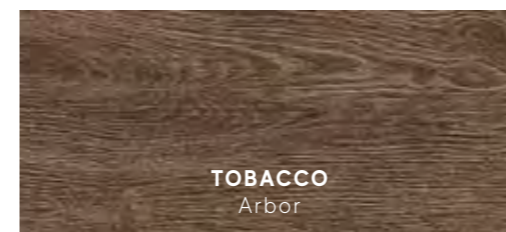
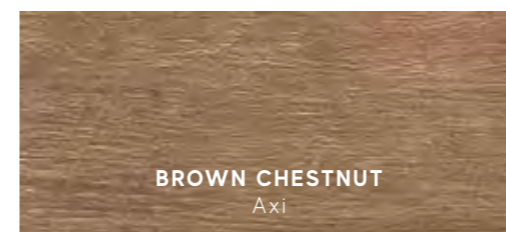
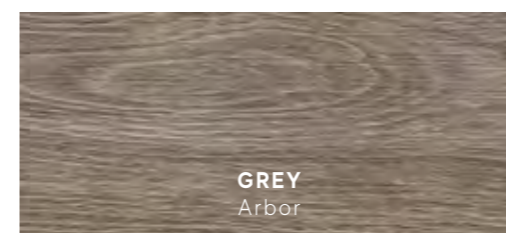
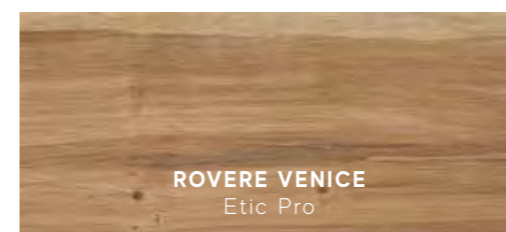
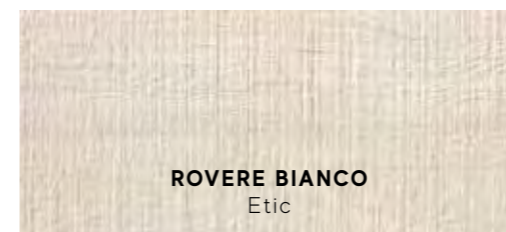
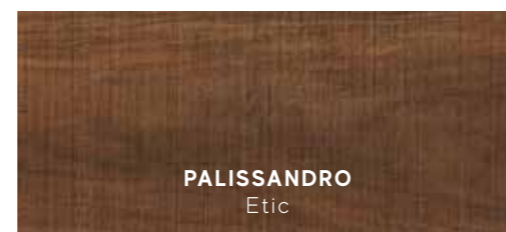
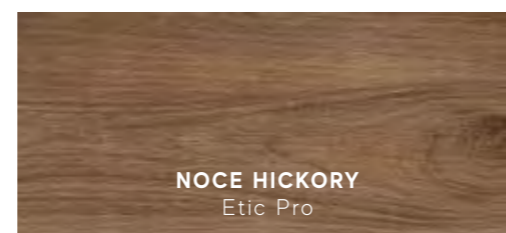
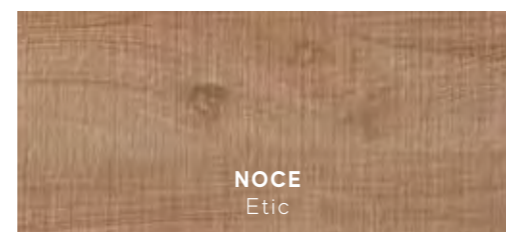
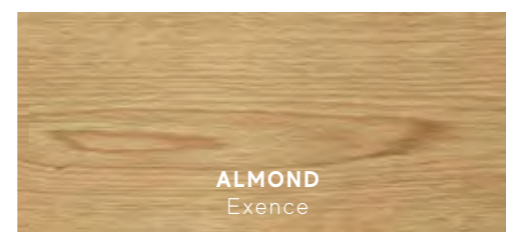
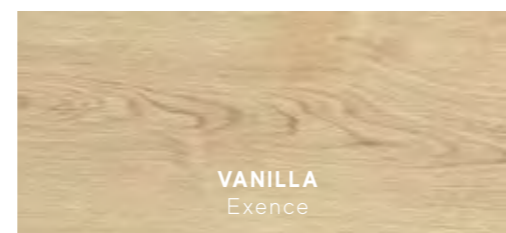
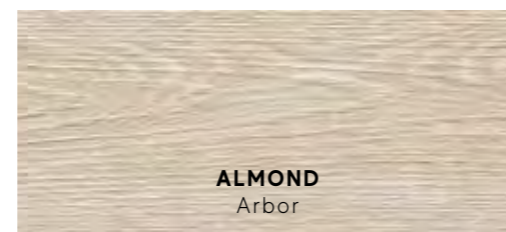

R11
A+B+C
ARBOR
AXI
ETIC
ETIC PRO
NASH
EXENCE

Porcelain Tiles / Gres Porcellanato

OUTDOOR PAVING / PAVIMENTI DA ESTERNO

WOOD LOOK

± 20 mm



Sizes	Thickness	Surface finish
30x120 cm - 11 ³ / ₄ "x47 ¹ / ₄ " > Exence	± 20 mm	Textured
40x120 cm - 15 ³ / ₄ "x47 ¹ / ₄ " > Axi, Nid	± 20 mm	Textured
30x120 cm - 11 ³ / ₄ "x47 ¹ / ₄ " > Etic Pro	± 20 mm	Textured
45x90 cm - 17 ³ / ₄ "x35 ³ / ₈ " > Axi	± 20 mm	Textured
60x60 cm - 23 ⁵ / ₈ "x23 ⁵ / ₈ " > Axi	± 20 mm	Textured

MARBLE LOOK

± 20 mm



Sizes	Thickness	Surface finish
60x60 cm - 23 ⁵ / ₈ "x23 ⁵ / ₈ " > Marvel Pro	± 20 mm	Textured

TEXTURED SURFACE / SUPERFICIE STRUTTURATA

± 9 mm

Sizes	Thickness	Surface finish
30x60 cm - 11 ³ / ₄ "x23 ⁵ / ₈ " > Marvel Pro	± 9 mm	Textured



**R11
A+B+C**
AXI
ETIC
ETIC PRO
NASH
EXENCE
MARVEL PRO

**R11
A+B**
MARVEL PRO

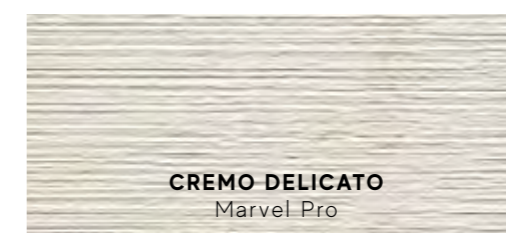
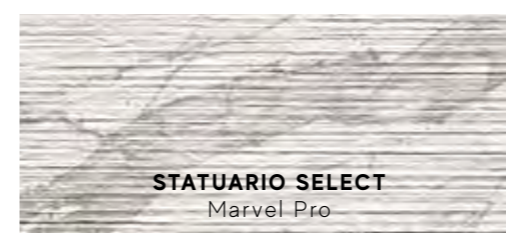
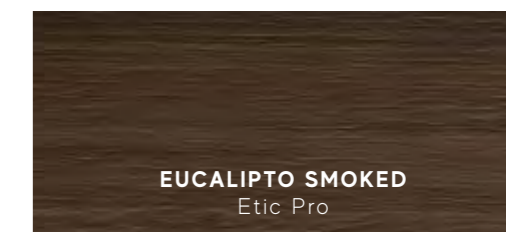
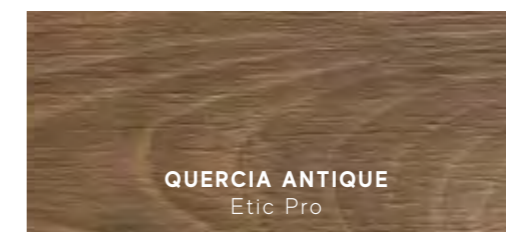
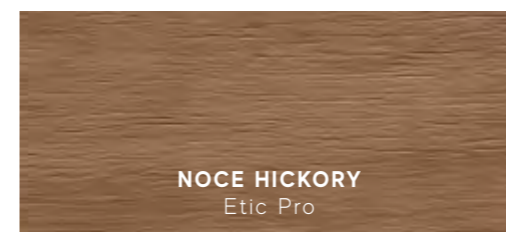
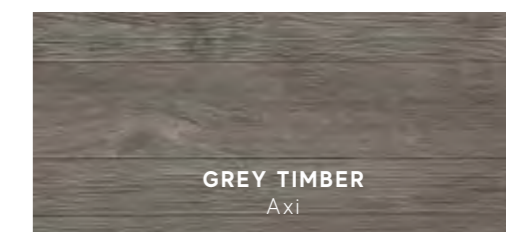
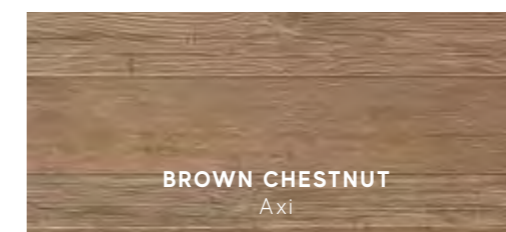
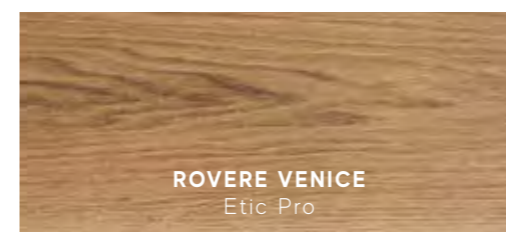
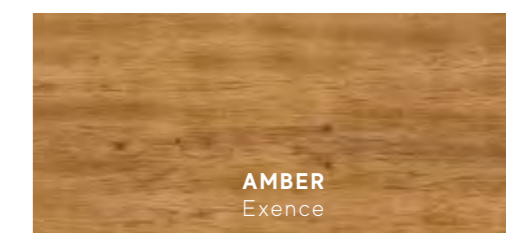
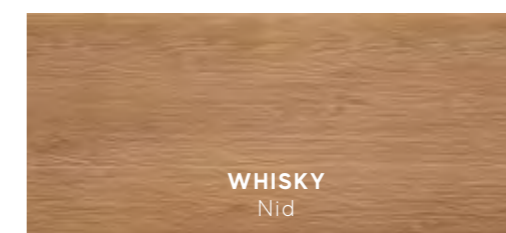
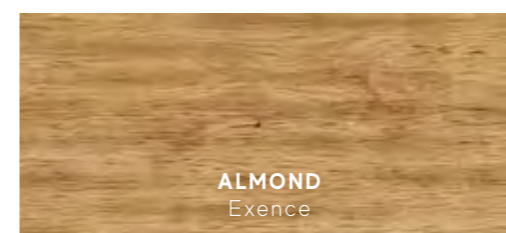
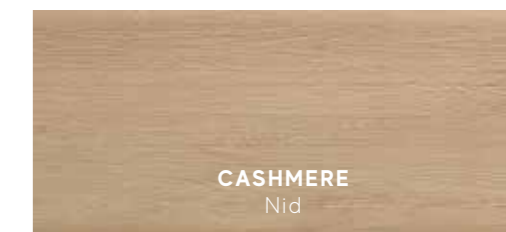

Porcelain Tiles / Gres Porcellanato

TEXTURED - GRIP SURFACE / SUPERFICIE STRUTTURATA - GRIP

CONCRETE LOOK

± 9 mm - 9,5 mm



Sizes	Thickness	Surface finish
120x120 cm - 47 ¹ / ₄ "x47 ¹ / ₄ " > Boost	± 9 mm	Grip
60x60 cm - 23 ⁵ / ₈ "x23 ⁵ / ₈ " > Mark	± 9 mm	Textured
37,5x75 cm - 14 ³ / ₄ "x29 ¹ / ₂ " > Raw	± 9 mm	Grip
30x60 cm - 11 ³ / ₄ "x23 ⁵ / ₈ " > Arkshade	± 9 mm	Grip
30x60 cm - 11 ³ / ₄ "x23 ⁵ / ₈ " > Mark	± 9 mm	Textured

METAL LOOK

± 9 mm - 9,5 mm



Sizes	Thickness	Surface finish
37,5x75 cm - 14 ³ / ₄ "x29 ¹ / ₂ " > Blaze	± 9 mm	Grip



R11
A+B

ARKSHADE

R11
A+B+C

BOOST
MARK
RAW
BLAZE

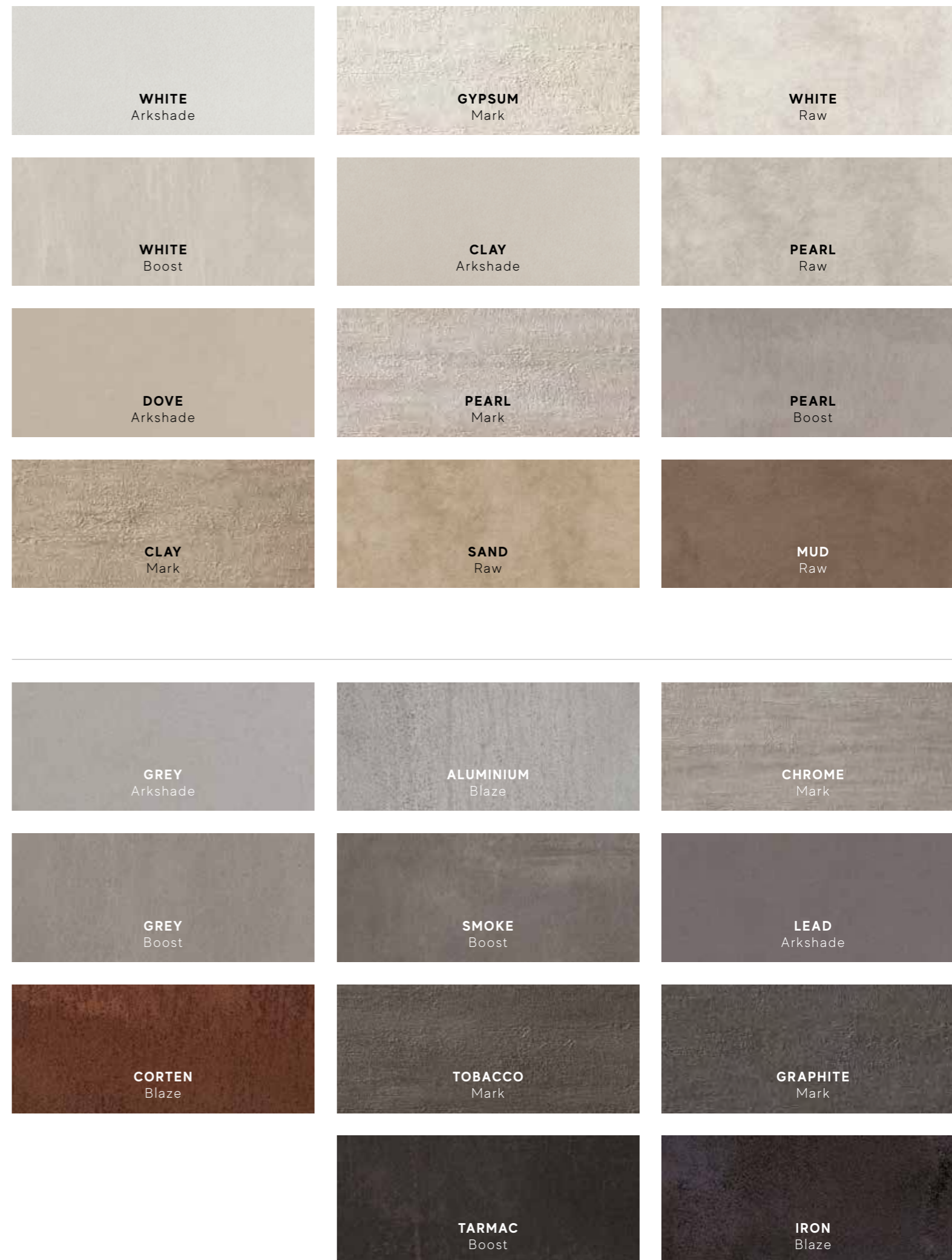

Porcelain Tiles / Gres Porcellanato

OUTDOOR PAVING / PAVIMENTI DA ESTERNO

CONCRETE LOOK

± 20 mm



Sizes	Thickness	Surface finish
120x240 cm - 47 ¹ / ₄ "x94 ¹ / ₂ " > Boost	± 20 mm	Textured
120x120 cm - 47 ¹ / ₄ "x47 ¹ / ₄ " > Boost, Raw	± 20 mm	Textured
60x120 cm - 23 ⁵ / ₈ "x47 ¹ / ₄ " > Boost, Raw	± 20 mm	Textured
90x90 cm - 35 ³ / ₈ "x35 ³ / ₈ " > Boost, Dwell	± 20 mm	Textured
60x60 cm - 23 ⁵ / ₈ "x23 ⁵ / ₈ " > Mark	± 20 mm	Textured

METAL LOOK

± 20 mm



Sizes	Thickness	Surface finish
120x120 cm - 47 ¹ / ₄ "x47 ¹ / ₄ " > Blaze	± 20 mm	Textured
60x60 cm - 23 ⁵ / ₈ "x23 ⁵ / ₈ " > Blaze	± 20 mm	Textured



R11
A+B+C

BOOST
DWELL
MARK
RAW
BLAZE

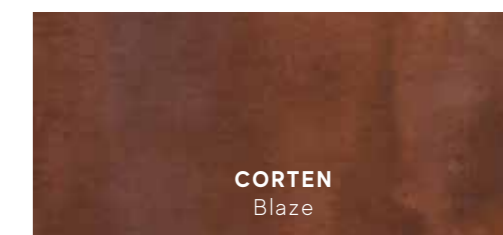
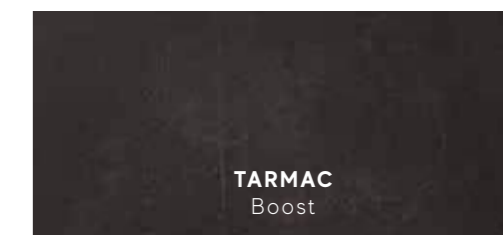
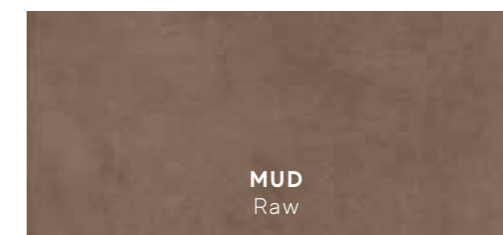
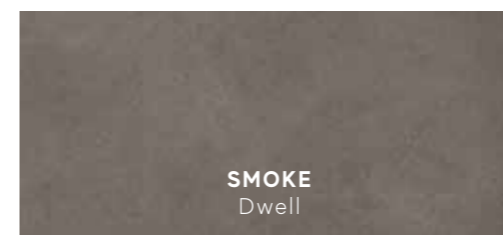
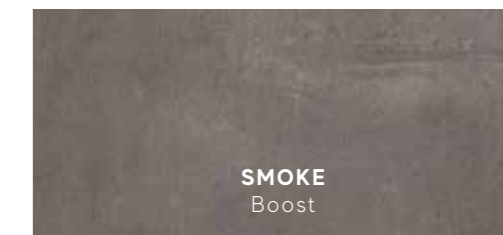
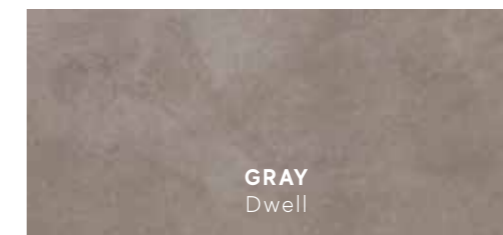
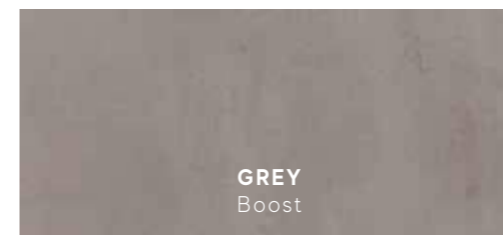
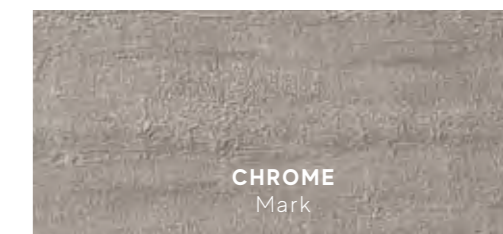
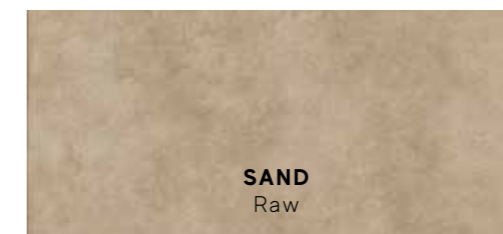
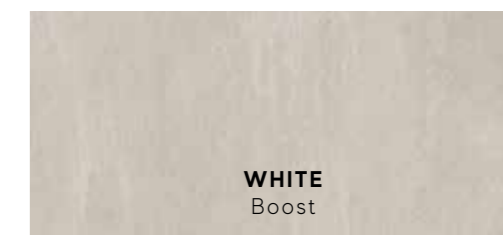
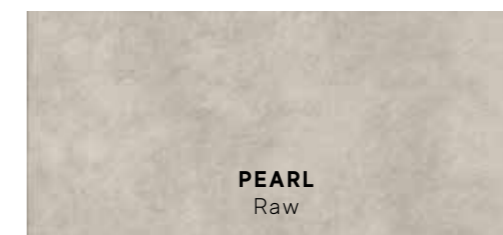
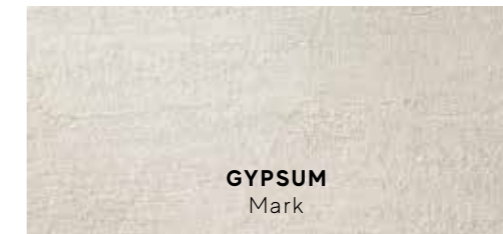

FOR FURTHER DETAILS ON THE 20MM THICK PRODUCTS, RELATED TRIM PIECES AND INSTALLATION SYSTEMS - IN PARTICULAR FOR RECOMMENDATIONS AND PRECAUTIONS DURING INSTALLATION- PLEASE REFER TO THE OUTDOOR DESIGN SECTION ON THE ATLAS CONCORDE WEBSITE OR TO THE OUTDOOR DESIGN CATALOGUE. / PER DETTAGLI SUL PRODOTTO E SUI RELATIVI PEZZI SPECIALI IN 20MM DI SPESSORE, PER I SISTEMI DI POSA E, IN PARTICOLARE, PER RACCOMANDAZIONI, ACCORGIMENTI E PRECAUZIONI IN FASE DI POSA E PROGETTAZIONE, SI RACCOMANDA DI PRENDERE VISIONE DEL CATALOGO OUTDOOR DESIGN E DELLA SEZIONE OUTDOOR DESIGN DEL SITO ATLAS CONCORDE. Pour plus de renseignements sur le produit, les pièces spéciales de 20mm d'épaisseur et sur les systèmes de pose, ainsi que pour tous conseils et recommandations et précautions d'emploi pendant la pose ou en phase de conception, nous vous recommandons de lire le catalogue Outdoor Design et de consulter la section Outdoor Design sur le site d'Atlas Concorde. / Bitte beachten Sie die detaillierten Informationen zum Produkt und zu den zugehörigen Formteilen in 20mm Stärke, zu den Verlegesystemen sowie vor allem die Empfehlungen, Tipps und bei der Planung und Verlegung zu beachtenden Vorsichtsmaßnahmen, die im Katalog Outdoor Design sowie im Bereich Outdoor Design der Atlas Concorde-Website aufgeführt sind. / Para mayor información sobre el producto y sus relativas piezas especiales de 20mm de grosor, para los sistemas de colocación, y en particular, para las recomendaciones, cautelas y precauciones en la fase de colocación y diseño, se recomienda consultar el catálogo Outdoor Design y la sección Outdoor Design del sitio Atlas Concorde. / Подробнее о плитках и о специальных элементах толщиной 20мм, о системах монтажа, о мерах предосторожности при проектировании и укладке можно узнать в каталоге Outdoor Design и в разделе Outdoor Design на сайте Atlas Concorde.

Porcelain Tiles / Gres Porcellanato

TRIM TILES / PEZZI SPECIALI

± 20 mm

			AIX	AXI	BLAZE	BOOST	BRAVE	DOLMEN PRO	DWELL	ECHO	ETIC PRO	EXENCE	KLIF	KONE	MARK	MARVEL STONE	MARVEL PRO	NID	RAW	SEASTONE	SUNROCK	TRUST	
Lineare	30x60 cm	11 ³ / ₄ "x23 ⁵ / ₈ "	•	•	•								•	•	•		•				•	•	
	33x120 cm	13"x47 ¹ / ₄ "		•														•					
Round	30x60 cm	11 ³ / ₄ "x23 ⁵ / ₈ "	•	•	•		•						•	•	•		•				•	•	•
	33x120 cm	13"x47 ¹ / ₄ "	•	•	•	•	•									•		•	•				•
	30x120 cm	11 ³ / ₄ "x47 ¹ / ₄ "									•	•											
Round Angolare Dx/Sx	60x90 cm	23 ⁵ / ₈ "x35 ³ / ₈ "	•																				
	45x90 cm	17 ³ / ₄ "x35 ³ / ₈ "		•		•	•		•	•			•	•									•
	30x60 cm	11 ³ / ₄ "x23 ⁵ / ₈ "	•	•	•		•						•	•	•		•				•	•	•
	33x120 cm	13"x47 ¹ / ₄ "	•	•	•	•	•									•		•	•				•
	30x120 cm	11 ³ / ₄ "x47 ¹ / ₄ "									•	•											
Round	60x60 cm	23 ⁵ / ₈ "x23 ⁵ / ₈ "	•	•	•		•					•	•	•		•				•	•	•	
Round Angolare	60x60 cm	23 ⁵ / ₈ "x23 ⁵ / ₈ "	•		•		•					•	•	•		•				•	•	•	
Round Angolare Dx/Sx	60x60 cm	23 ⁵ / ₈ "x23 ⁵ / ₈ "		•													•						
Gradino Round	30x60 cm	11 ³ / ₄ "x23 ⁵ / ₈ "	•	•	•		•						•	•	•		•			•	•	•	
Gradino Round Angolare Dx/Sx	30x60 cm	11 ³ / ₄ "x23 ⁵ / ₈ "	•	•	•		•						•	•	•		•			•	•	•	
Elemento L	20x60 cm	7 ⁷ / ₈ "x23 ⁵ / ₈ "	•	•	•		•						•	•	•		•			•	•	•	
	33x120 cm	13"x47 ¹ / ₄ "	•	•	•	•	•									•		•	•			•	
Elemento L Angolare	33x90 cm	13"x35 ³ / ₈ "	•	•		•	•		•	•			•	•									•
	20x20 cm	7 ⁷ / ₈ "x7 ⁷ / ₈ "	•		•		•				•		•	•	•						•	•	•
Elemento L Angolare Dx/Sx	33x33 cm	13"x13"	•		•	•	•	•	•				•	•	•				•				•
	20x20 cm	7 ⁷ / ₈ "x7 ⁷ / ₈ "		•							•						•						•
Alzata	33x33 cm	13"x13"		•														•					•
	20x120 cm	7 ⁷ / ₈ "x47 ¹ / ₄ "	•	•	•	•	•									•		•	•			•	
	30x120 cm	11 ³ / ₄ "x47 ¹ / ₄ "									•	•											•
Top	20x90 cm	7 ⁷ / ₈ "x35 ³ / ₈ "	•	•		•	•		•	•			•	•									•
	30x60 cm	11 ³ / ₄ "x23 ⁵ / ₈ "	•	•	•		•						•	•	•		•			•	•	•	
Costa Design	30x120 cm	11 ³ / ₄ "x47 ¹ / ₄ "	•	•	•	•	•				•	•						•	•				•
	33x120 cm	13"x47 ¹ / ₄ "	•		•	•	•	•								•			•				•
Bordo Piscina	30x60 cm	11 ³ / ₄ "x23 ⁵ / ₈ "	•	•	•		•						•	•	•		•			•	•	•	
Bordo Piscina Angolare Dx/Sx	30x60 cm	11 ³ / ₄ "x23 ⁵ / ₈ "	•	•	•		•						•	•	•		•			•	•	•	
Griglia	15x60 cm	5 ⁷ / ₈ "x23 ⁵ / ₈ "	•	•			•						•	•	•		•			•	•	•	
	20x60 cm	7 ⁷ / ₈ "x23 ⁵ / ₈ "	•	•	•		•						•	•	•		•			•	•	•	
Griglia Angolare Dx/Sx	15x60 cm	5 ⁷ / ₈ "x23 ⁵ / ₈ "	•	•	•		•						•	•	•		•			•	•	•	
	20x60 cm	7 ⁷ / ₈ "x23 ⁵ / ₈ "	•	•	•		•						•	•	•		•			•	•	•	
Curve	60x60 cm	23 ⁵ / ₈ "x23 ⁵ / ₈ "	•	•	•		•						•	•	•		•			•	•	•	
Smussato	30x60 cm	11 ³ / ₄ "x23 ⁵ / ₈ "	•	•	•		•						•	•	•		•			•	•	•	

LINEARE

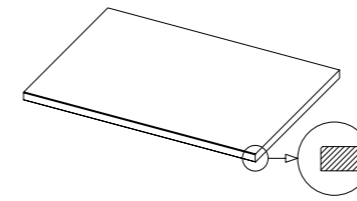

ROUND ♦

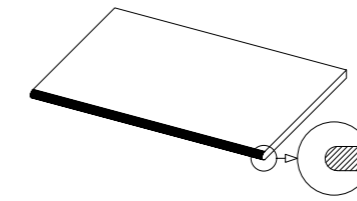

ROUND 60 ♦

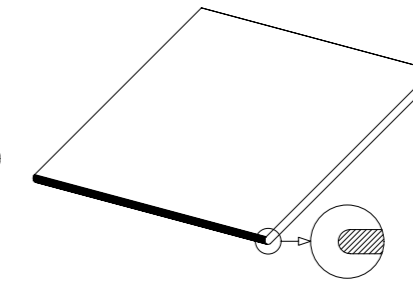

GRADINO ROUND 60 ♦

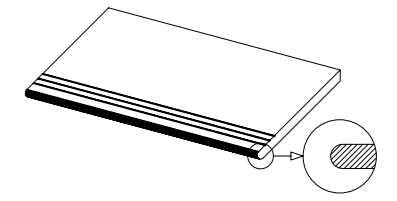

ELEMENTO L ♦

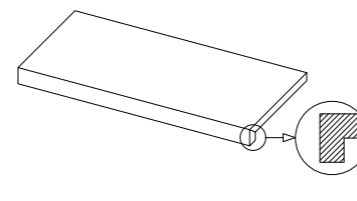

ALZATA

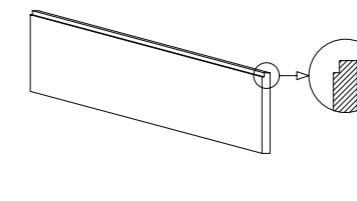

TOP

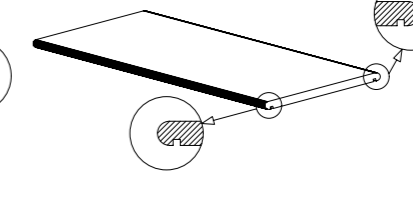

COSTA DESIGN

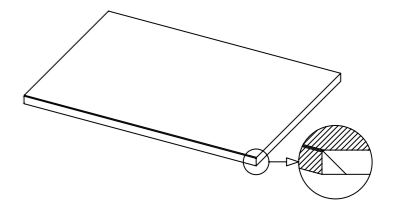

BORDO PISCINA ♦

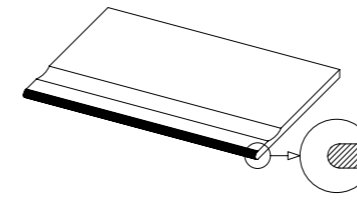

GRIGLIA ♦

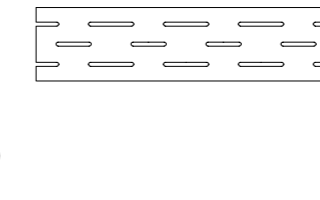

CURVE

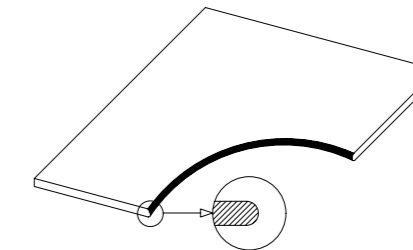

SMUSSATO

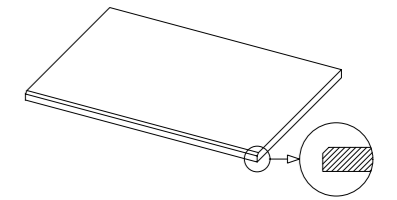

♦ Right/left angular elements are available / Sono disponibili gli elementi angolari dx/sx

LASTRA STEPS

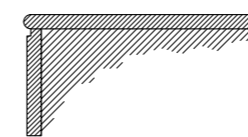

Round + Alzata

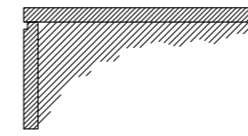

Lineare + Alzata

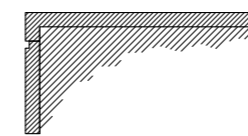

Elemento L + Alzata



atlasconcerde

Porcelain Tiles / Gres Porcellanato

TRIM TILES / PEZZI SPECIALI

± 9 mm - 9,5 mm

INDOOR

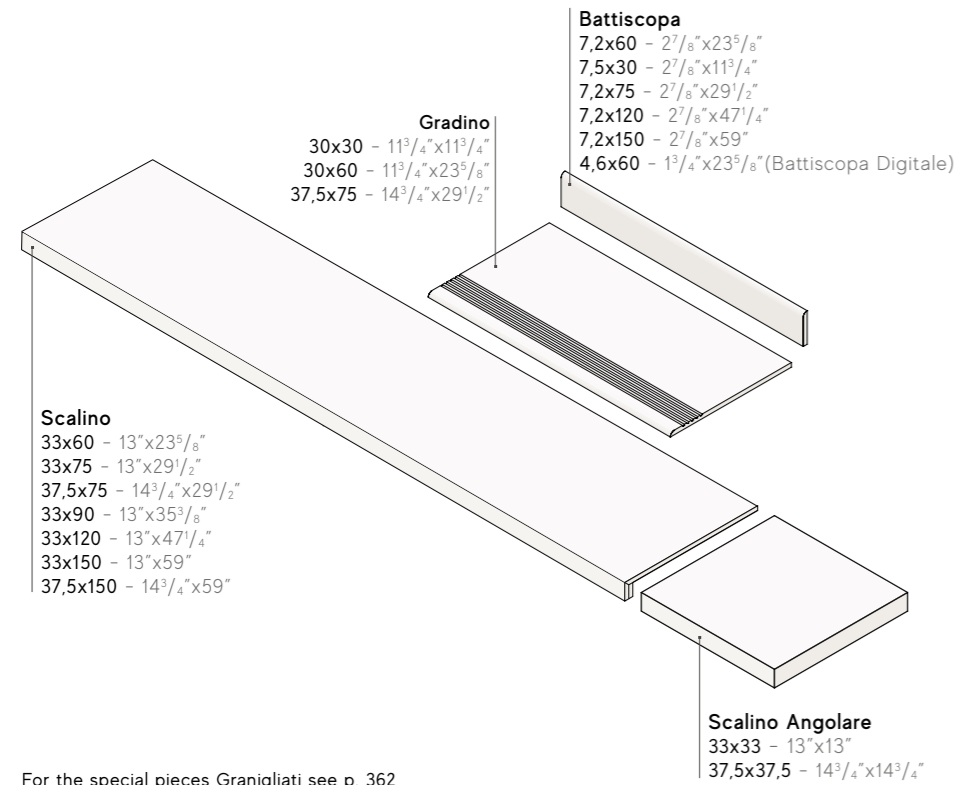

For the special pieces Granigliati see p. 362
 Per i pezzi Speciali Granigliati vedi p. 362
 Pour les pièces Speciali Granigliati voir page 362
 Für die Formteile Granigliati siehe Seite 362
 Para las piezas especiales Granitos, consultar la pág. 362
 Специальные элементы Granigliati см. на стр. 362

OUTDOOR

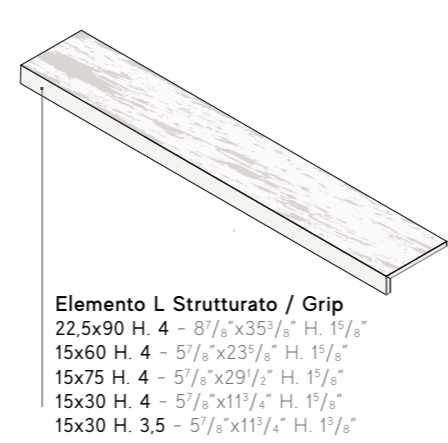

Battiscopa Sagomato

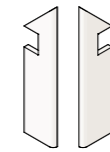

Battiscopa Sag. Scala Dx / Sx
 7,5x30 - 3"x11³/₄"
 7,2x30 - 2⁷/₈"x11³/₄"

Technical Specifications / Specifiche Tecniche

GRADINO

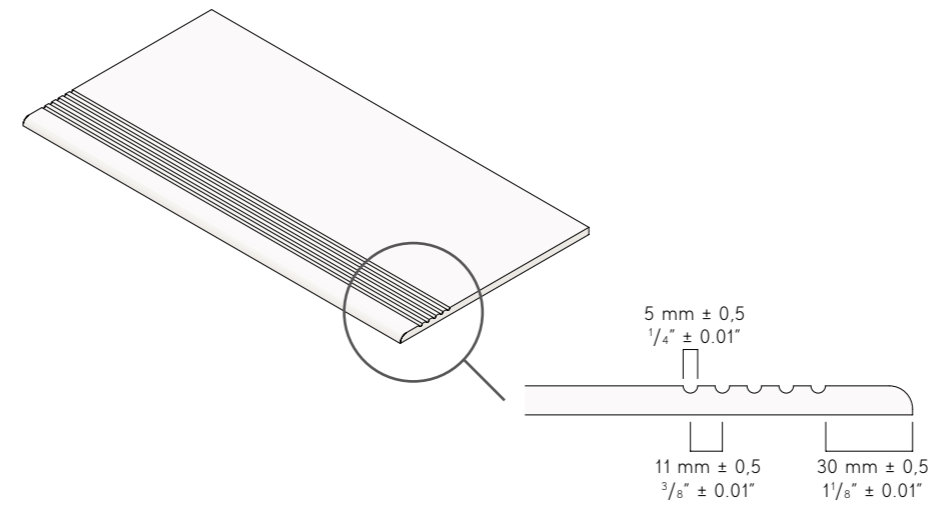

BATTISCOPA SAGOMATO

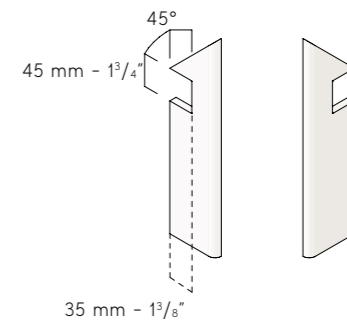

SCALINO

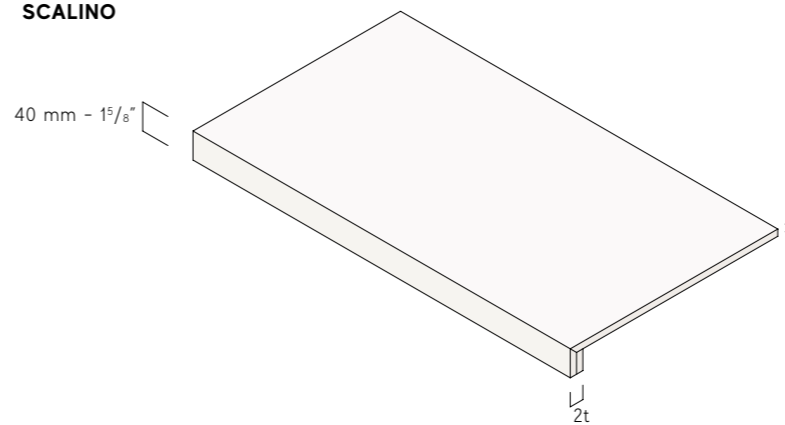

ELEMENTO L STRUTTURATO/GRIP

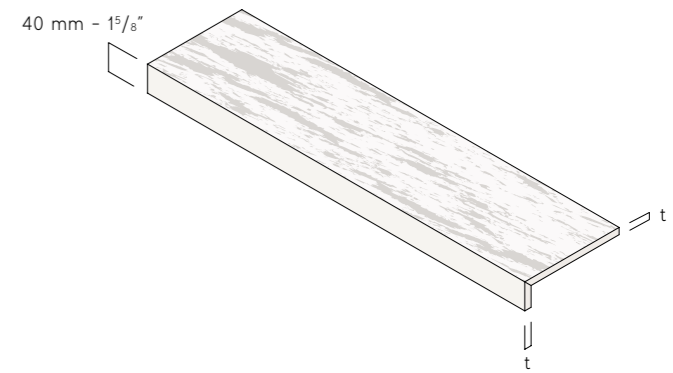

WOOD LOOK

INDOOR

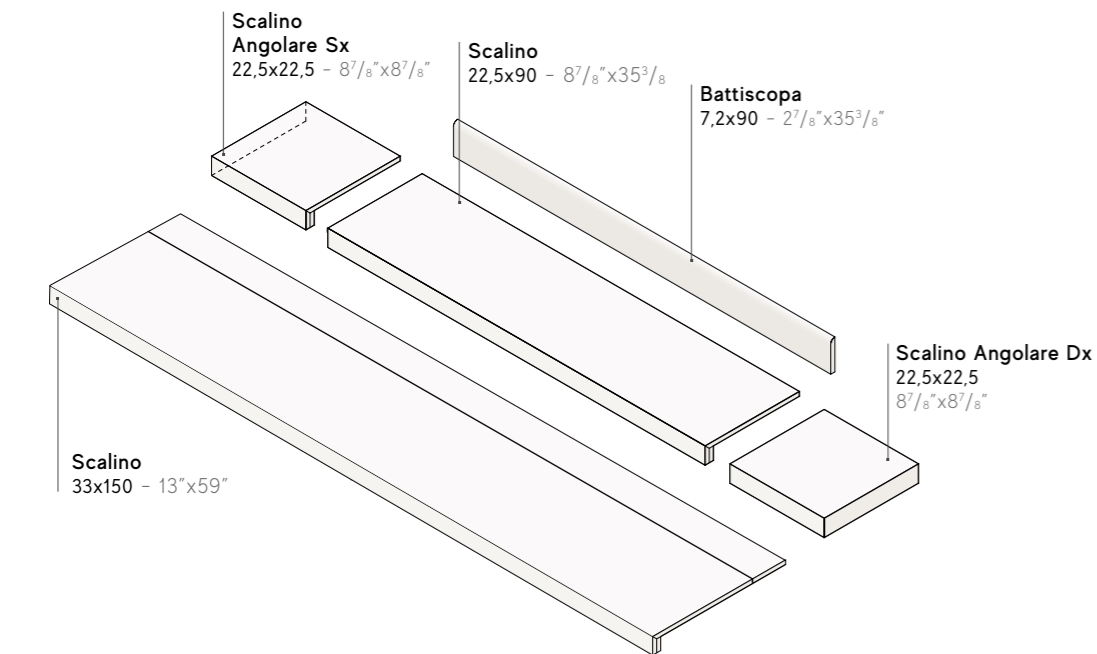

OUTDOOR

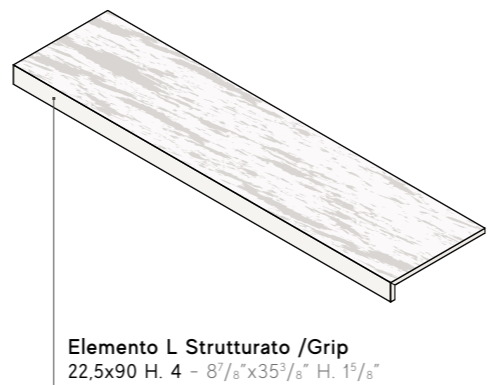

SCALINO ANGOLARE

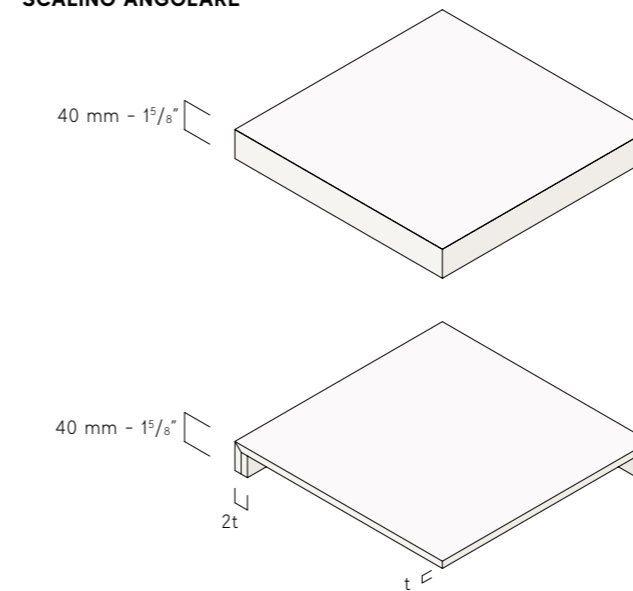

t = thickness

OUTDOOR PAVING



Wall Tiles

428	3D Wall Design	Wall Tiles
438	Brick Atelier	Wall Tiles
442	Aix	Wall Tiles
446	Arkshade	Wall Tiles
454	Arty	Wall Tiles
460	Blaze	Wall Tiles
466	Boost	Wall Tiles
470	Brave	Wall Tiles
474	Dwell	Wall Tiles
480	Ewall	Wall Tiles
486	Klif	Wall Tiles
490	Kone	Wall Tiles
494	Marvel	Wall Tiles
502	Marvel Dream	Wall Tiles
508	Marvel Edge	Wall Tiles
516	Marvel Pro	Wall Tiles
524	Marvel Stone	Wall Tiles
532	Mek	Wall Tiles
538	Raw	Wall Tiles



atlas concorde

3D WALL DESIGN

3D WALL TILES

3D Wall Tiles / Rivestimento 3D

WHITEBODY WALL TILES - RECTIFIED MONOCALIBER
RIVESTIMENTI IN PASTA BIANCA - RETTIFICATO MONOCALIBRO

Sinuous Design



Multi-Faceted Design



Geometric Design



Sizes	Thickness	Surface finish
50x110 cm - 19 ⁵ / ₈ "x43 ¹ / ₄ "	± 11 mm	Matte, Shiny
40x80 cm - 15 ³ / ₄ "x31 ¹ / ₂ "	± 10 mm	Matte, Shiny
30,5x56 cm - 12"x22"	± 9,5 mm	Matte

Solid Design



Sizes	Thickness	Surface finish
50x110 cm - 19 ⁵ / ₈ "x43 ¹ / ₄ "	± 8,5 mm	Matte, Shiny
40x80 cm - 15 ³ / ₄ "x31 ¹ / ₂ "	± 8,5 mm	Matte, Shiny
30,5x56 cm - 12"x22"	± 8,5 mm	Matte

3D Wall Tiles / Rivestimento 3D

MATTE SURFACE / SUPERFICIE MATT



4D3P 3D Plot White Matt 110 *
50x110 cm - 19⁵/₈"x43³/₄"



4D3M 3D Ultra Blade White Matt 110 *
50x110 cm - 19⁵/₈"x43³/₄"

SHINY SURFACE / SUPERFICIE LUCIDA



4D3G 3D Ultra Blade White Glossy 110 *
50x110 cm - 19⁵/₈"x43³/₄"



4D3K 3D Kite White Matt 110 *
50x110 cm - 19⁵/₈"x43³/₄"

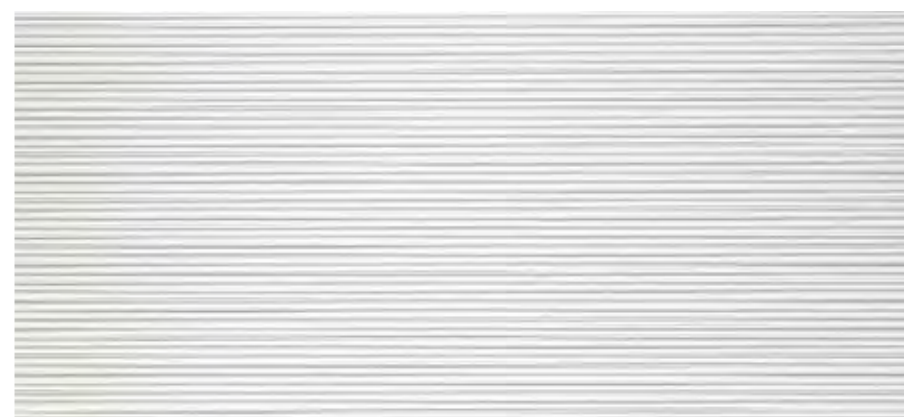

4D3L 3D Line White Matt 110 *
50x110 cm - 19⁵/₈"x43³/₄"



4D3F 3D Flows White Matt 110 *
50x110 cm - 19⁵/₈"x43³/₄"



**V1
UNIFORM
VARIATION**
White

* Registered Community Design

MATTE SURFACE / SUPERFICIE MATT | Surface Mat | Matt oberfläche | Superficie Mate | Матовая поверхность



**V1
UNIFORM
VARIATION**
White

431

* Registered Community Design

MATTE SURFACE / SUPERFICIE MATT | Surface Mat | Matt oberfläche | Superficie Mate | Матовая поверхность
SHINY SURFACE / SUPERFICIE LUCIDA | Surface brillante | Glänzende oberfläche | Superficie brillante | Глянцевая поверхность

3D Wall Tiles / Rivestimento 3D

MATTE SURFACE / SUPERFICIE MATT



8DMA 3D Angle White Matt 80 *
40x80 cm - 15³/₄"x31¹/₂"



8DBW 3D Blade White Matt 80 *
40x80 cm - 15³/₄"x31¹/₂"



8DFW 3D Flash White Matt 80 *
40x80 cm - 15³/₄"x31¹/₂"

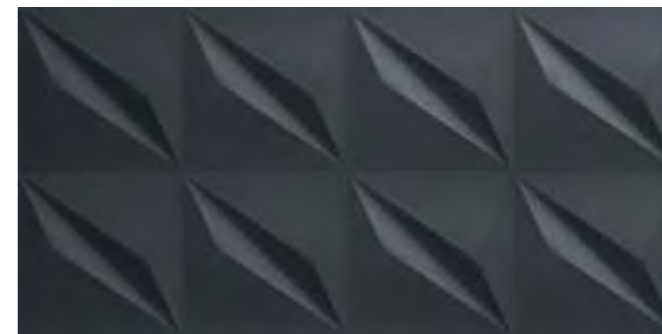

8DFN 3D Flash Night Matt 80 *
40x80 cm - 15³/₄"x31¹/₂"



8DWF 3D Flake White Matt 80 *
40x80 cm - 15³/₄"x31¹/₂"

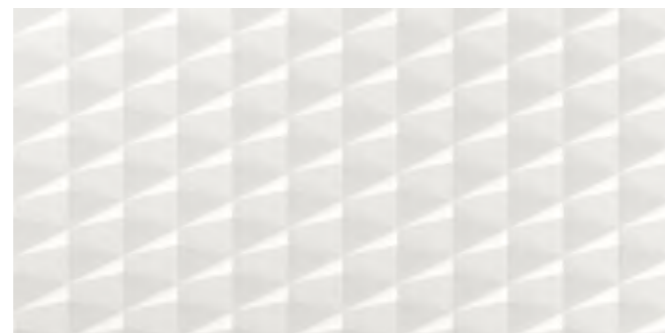

8DAW 3D Stars White Matt 80 *
40x80 cm - 15³/₄"x31¹/₂"



8DDI 3D Diamond White Matt 80 *
40x80 cm - 15³/₄"x31¹/₂"



8DDN 3D Diamond Night Matt 80 *
40x80 cm - 15³/₄"x31¹/₂"



8DMH 3D Mesh White Matt 80 *
40x80 cm - 15³/₄"x31¹/₂"

* Registered Community Design

* Registered Community Design



V1
UNIFORM
VARIATION
White



V1
UNIFORM
VARIATION
White
Night

3D Wall Tiles / Rivestimento 3D

MATTE SURFACE / SUPERFICIE MATT



8DMW 3D Wind White Matt 80 *
40x80 cm - 15³/₄"x31¹/₂"



8DWS 3D Wind Sand Matt 80 *
40x80 cm - 15³/₄"x31¹/₂"



8DUW 3D Dune White Matt 80 *
40x80 cm - 15³/₄"x31¹/₂"



8DUS 3D Dune Sand Matt 80 *
40x80 cm - 15³/₄"x31¹/₂"



8DWM 3D Twist White Matt 80 *
40x80 cm - 15³/₄"x31¹/₂"

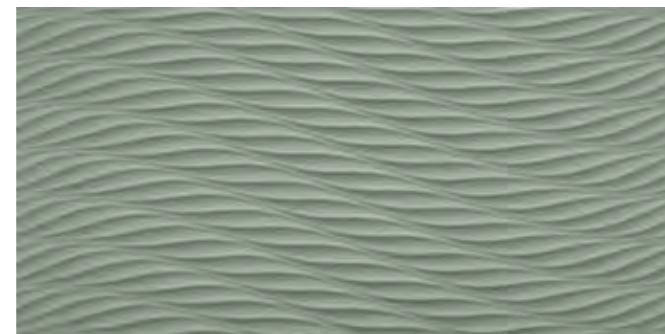

8DSM 3D Twist Sage Matt 80 *
40x80 cm - 15³/₄"x31¹/₂"

* Registered Community Design

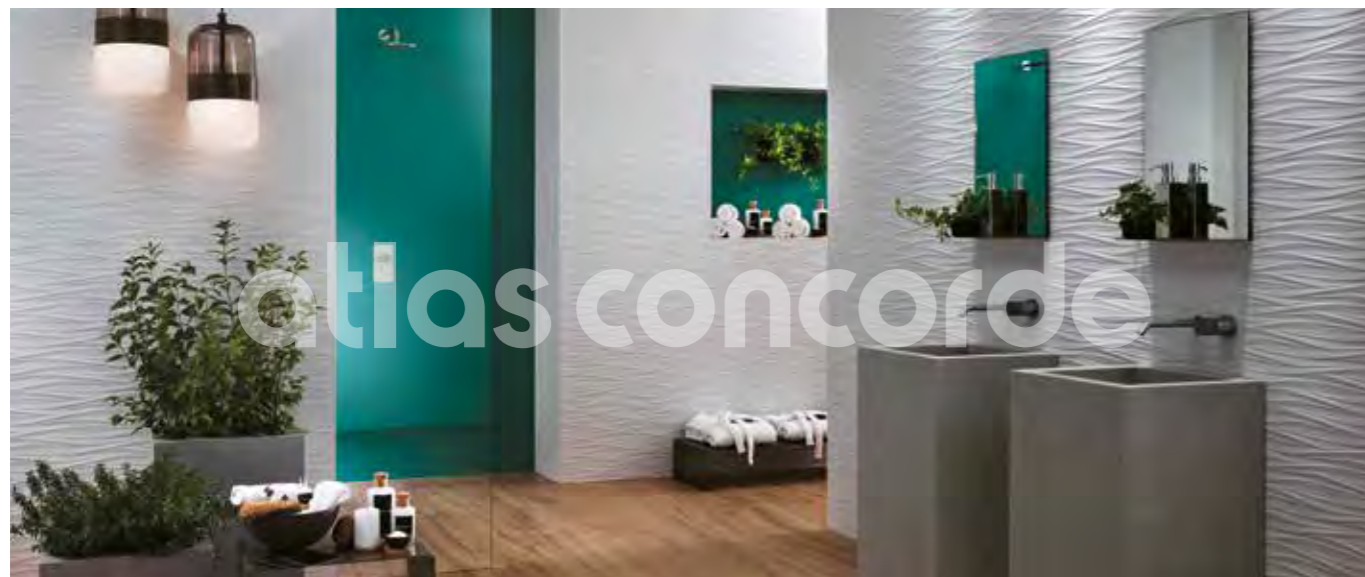

V1
UNIFORM
VARIATION
White
Sand
Sage

MATTE SURFACE / SUPERFICIE MATT | Surface Mat | Matt Oberfläche | Superficie Mate | Матовая поверхность



8SBW 3D Ribbon White Matt 80 *
40x80 cm - 15³/₄"x31¹/₂"



8SBS 3D Ribbon Sand Matt 80 *
40x80 cm - 15³/₄"x31¹/₂"



8AWS Arty Sugar Wave Matt 80 *
40x80 cm - 15³/₄"x31¹/₂"



8AWM Arty Milk Wave Matt 80 *
40x80 cm - 15³/₄"x31¹/₂"

SHINY SURFACE / SUPERFICIE LUCIDA



8DWG 3D Wave White Glossy 80 *
40x80 cm - 15³/₄"x31¹/₂"

* Registered Community Design



V1
UNIFORM
VARIATION
White
Sand
Sugar
Milk

MATTE SURFACE / SUPERFICIE MATT | Surface Mat | Matt Oberfläche | Superficie Mate | Матовая поверхность
SHINY SURFACE / SUPERFICIE LUCIDA | Surface brillante | Glänzende Oberfläche | Superficie brillante | Глянцевая поверхность

3D Wall Tiles / Rivestimento 3D

MATTE SURFACE / SUPERFICIE MATT



9D5B 3D Ultra Blade White Matt 56 *
30,5x56 cm - 12"x22"



9D5L 3D Line White Matt 56 *
30,5x56 cm - 12"x22"



9D5W 3D Wave White Matt 56 *
30,5x56 cm - 12"x22"

DECOR RANGE / GAMMA DECORI

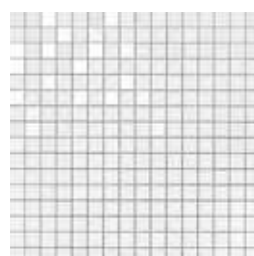

9DSM Solid White Mosaic
30,5x30,5 - 12"x12"

TRIM TILES / PEZZI SPECIALI

LDWM Spigolo 10mm White Matt *
1x20 cm - 3/8"x7 7/8"

LDWG Spigolo 10mm White Glossy *
1x20 cm - 3/8"x7 7/8"

LDAM Spigolo 10mm Sand Matt *
1x20 cm - 3/8"x7 7/8"

LDNM Spigolo 10mm Night Matt *
1x20 cm - 3/8"x7 7/8"

* THESE PARTS ARE SUPPLIED TO ORDER . I PEZZI SONO DISPONIBILI SU ORDINAZIONE
Les pièces sont disponibles sur commande | Die Teile sind auf Bestellung lieferbar | Las piezas se hacen por encargo | Изготавливаются на заказ

* Registered Community Design



The 10 mm edge matches three-dimensional wall tiles having a 10-11 mm thickness / Lo spigolo 10 mm si abbina a rivestimenti tridimensionali di spessore 10-11 mm / Le bord 10 mm s'adapte aux revêtements tridimensionnels épaisseur 10-11 mm / Die 10 mm Kante ist mit dreidimensionalen Wandfliesen mit einer Dicke von 10-11 mm kombinierbar / La arista de 10 mm se combina con revestimientos tridimensionales de 10 -11 mm de grosor / Угловой элемент 10 мм сочетается с трехмерной настенной плиткой толщиной 10-11 мм

MATTE SURFACE | SUPERFICIE MATT | Surface Mat | Matt oberfläche | Superficie Mate | Матовая поверхность



3D Wall Tiles / Rivestimento 3D

MATTE&SHINY SURFACE / SUPERFICIE MATT E LUCIDA ± 8,5 mm

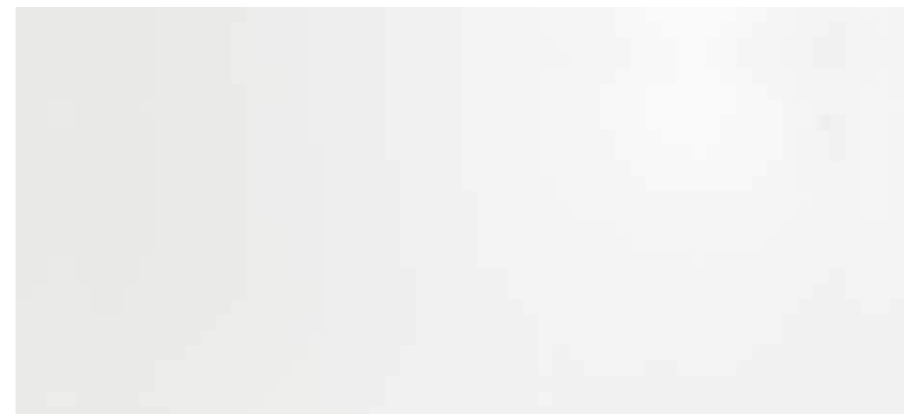

4DWM Solid White Matt 110
50x110 cm - 19 7/8"x43 3/4"

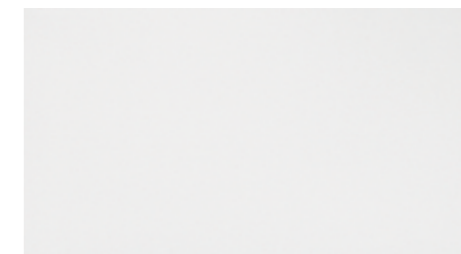

9D5S Solid White Matt 56
30,5x56 cm - 12"x22"



4DWO Solid White Glossy 110
50x110 cm - 19 7/8"x43 3/4"

TRIM TILES / PEZZI SPECIALI

LD8W Spigolo 8,5mm White Matt
0,8x20 cm - 3/8"x7 7/8"

A8DW Spigolo 8,5mm White Matt A.E.
0,8x0,8 cm - 3/8"x3/8"

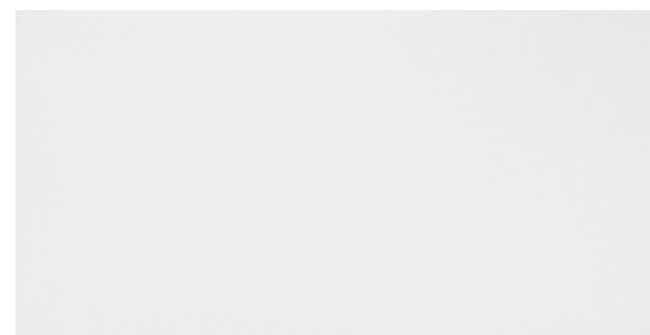

8DSO Solid White Matt 80
40x80 cm - 15 3/4"x31 1/2"

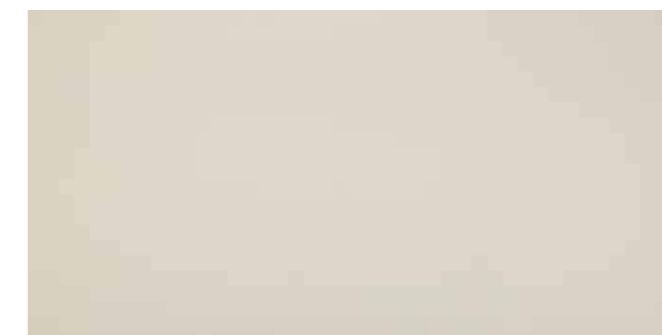

8DSA Solid Sand Matt 80
40x80 cm - 15 3/4"x31 1/2"

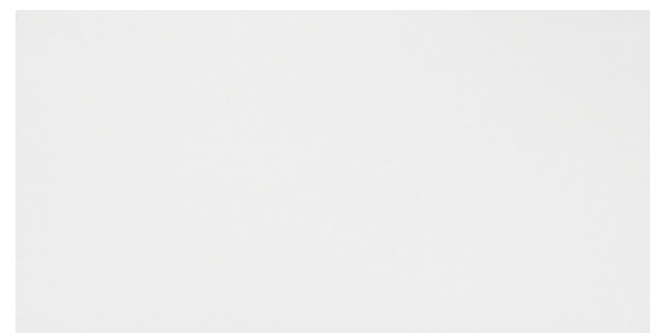

8DSL Solid White Glossy 80
40x80 cm - 15 3/4"x31 1/2"

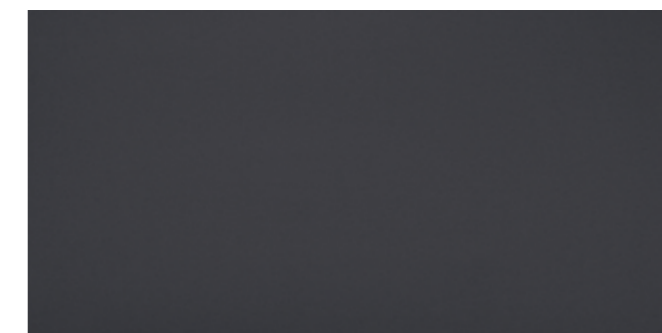

8DSI Solid Night Matt 80
40x80 cm - 15 3/4"x31 1/2"



V1
UNIFORM
VARIATION
White

MATTE SURFACE | SUPERFICIE MATT | Surface Mat | Matt oberfläche | Superficie Mate | Матовая поверхность
SHINY SURFACE | SUPERFICIE LUCIDA | Surface brillante | Glänzende oberfläche | Superficie brillante | Плещ поверхность



V1
UNIFORM
VARIATION
White
Sand
Night



THE BRICK ATELIER

WALL TILES

Wall tiles / Rivestimento

WHITEBODY WALL TILES - RECTIFIED MONOCALIBER
RIVESTIMENTI IN PASTA BIANCA - RETTIFICATO MONOCALIBRO

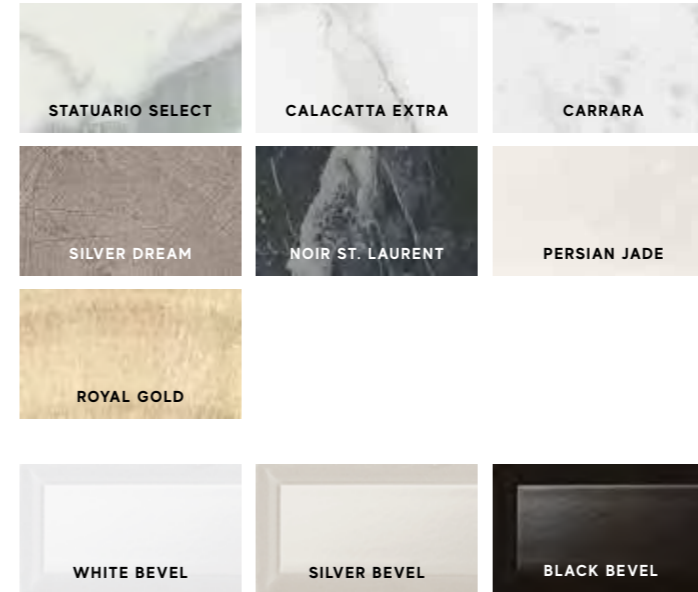

Sizes	Thickness	Surface finish
8x31,5 cm - 3 1/8" x 12 3/8"	± 8,5 mm ± 10 mm	Shiny



WHITEBODY WALL TILES | RIVESTIMENTI IN PASTA BIANCA | Revêtements en pâte blanche | Weißscherbige Wandfliesen | Revestimientos en pasta blanca | Настенная плитка из белой глины
RECTIFIED MONOCALIBER | RETTIFICATO MONOCALIBRO | Rectifié mono-calibre | Geschliffen einkalbrig | Rectificado monocalibré | Ретицированный в одном калибре

Brick Atelier Wall Tiles / Rivestimento

SHINY SURFACE / SUPERFICIE LUCIDA



LMKT Brick Statuario Select
8x31,5 - 3/8"x12 3/8"



LMKC Brick Calacatta Extra
8x31,5 - 3/8"x12 3/8"



AZA2 Brick Carrara
8x31,5 - 3/8"x12 3/8"



LMKS Brick Silver Dream
8x31,5 - 3/8"x12 3/8"



LMKN Brick Noir S. Laurent
8x31,5 - 3/8"x12 3/8"



AZA3 Brick Persian Jade
8x31,5 - 3/8"x12 3/8"



AZA4 Brick Royal Gold
8x31,5 - 3/8"x12 3/8"

COORDINATED TRIM TILES / PEZZI SPECIALI IN ABBINAMENTO



LVLS Marvel Statuario Select London
5x30,5 - 2"x12"



LVLN Marvel Noir St. Laurent London
5x30,5 - 2"x12"



ASDZ Marvel Calacatta London
5x30,5 - 2"x12"



ASD4 Marvel Silver London
5x30,5 - 2"x12"



AVLS Marvel London A.E.
5x2,5 - 2"x1"



AVLN Marvel London A.E.
5x2,5 - 2"x1"



ASD7 Marvel London A.E.
5x2,5 - 2"x1"



ASEC Marvel London A.E.
5x2,5 - 2"x1"

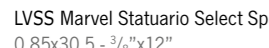

LVSS Marvel Statuario Select Spigolo
0,85x30,5 - 3/8"x12"

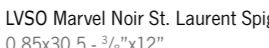

LVSO Marvel Noir St. Laurent Spigolo
0,85x30,5 - 3/8"x12"

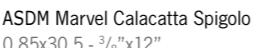

ASDM Marvel Calacatta Spigolo
0,85x30,5 - 3/8"x12"



ASDQ Marvel Silver Spigolo
0,85x30,5 - 3/8"x12"



AVSS Marvel Spigolo A.E.
0,85x0,85 - 3/8"x3/8"

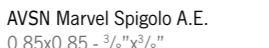

AVSN Marvel Spigolo A.E.
0,85x0,85 - 3/8"x3/8"

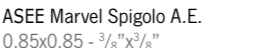

ASEE Marvel Spigolo A.E.
0,85x0,85 - 3/8"x3/8"

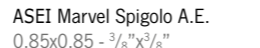

ASEI Marvel Spigolo A.E.
0,85x0,85 - 3/8"x3/8"



LVAS Marvel Statuario Select Alzata
20x30,5 - 7 7/8"x12"

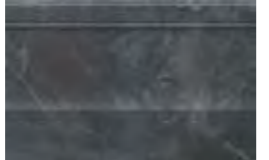

LVAN Marvel Noir St. Laurent Alzata
20x30,5 - 7 7/8"x12"



ASDG Marvel Calacatta Alzata
20x30,5 - 7 7/8"x12"



ASDK Marvel Silver Alzata
20x30,5 - 7 7/8"x12"



AVAA Marvel Alzata A.E.
1,5x20 - 5/8"x7 7/8"



AVAN Marvel Alzata A.E.
1,5x20 - 5/8"x7 7/8"



ASDT Marvel Alzata A.E.
1,5x20 - 5/8"x7 7/8"



ASDX Marvel Alzata A.E.
1,5x20 - 5/8"x7 7/8"



LMLJ Persian Jade London
5x31,5 - 2"x12 3/8"

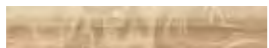

LMLY Royal Gold London
5x31,5 - 2"x12 3/8"



LSLH Marvel Carrara London
5x30,5 - 2"x12"

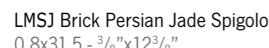

LMSJ Brick Persian Jade Spigolo
0,8x31,5 - 3/8"x12 3/8"

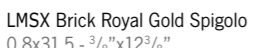

LMSX Brick Royal Gold Spigolo
0,8x31,5 - 3/8"x12 3/8"

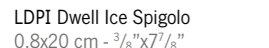

LDPI Dwell Ice Spigolo
0,8x20 cm - 3/8"x7 7/8"

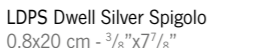

LDPS Dwell Silver Spigolo
0,8x20 cm - 3/8"x7 7/8"



AZM3 Black Spigolo
0,8x20 cm - 3/8"x7 7/8"

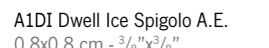

A1DI Dwell Ice Spigolo A.E.
0,8x0,8 cm - 3/8"x3/8"



A1DS Dwell Silver Spigolo A.E.
0,8x0,8 cm - 3/8"x3/8"



AZM4 Black Spigolo A.E.
0,8x0,8 cm - 3/8"x3/8"



AZDA Brick White Bevel
8x31,5 - 3/8"x12 3/8"



AZDB Brick Silver Bevel
8x31,5 - 3/8"x12 3/8"



AZDC Brick Black Bevel
8x31,5 - 3/8"x12 3/8"

COORDINATED DECORS / DECORI IN ABBINAMENTO

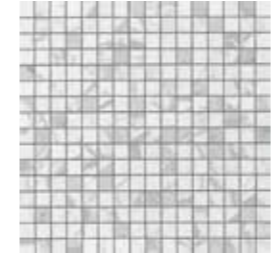

9MVS Marvel Statuario Select Mosaic
30,5x30,5 - 12"x12"



9MVN Marvel Noir St. Laurent Mosaic
30,5x30,5 - 12"x12"

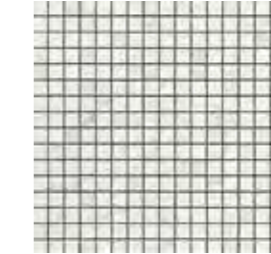

ASCM Marvel Calacatta Mosaic
30,5x30,5 - 12"x12"

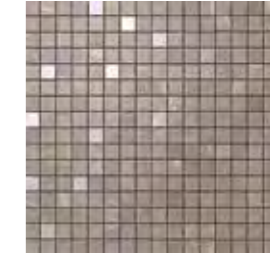

ASCR Marvel Silver Mosaic
30,5x30,5 - 12"x12"



9MVH Marvel Noir Mix Diagonal Mosaic
30,5x30,5 - 12"x12"



ASDE Marvel Calacatta Fregio
10x30,5 - 3/8" x12"



ASCV Marvel Silver Net Mosaic
30,5x30,5 - 12"x12"



LVGB Marvel Gold Black •
7,8x30,5 - 3/8"x12"

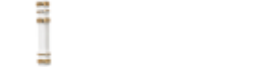

ASEM Marvel Greca A.E. •
7,8x1,2 - 3/8"x1/2"



AVGB Marvel Gold Black A.E. •
7,8x1,2 - 3/8"x1/2"

• **DECOR WITH GOLD INSERT.**
DECORO CON INSERTO IN ORO.
Décor avec insert en OR.
Dekor mit Einlage GOLD.
Decoración con aplicación de ORO.
Декор с ЗОЛОТОЙ вставкой.



**V3
MODERATE
VARIATION**
Statuario Select,
Calacatta Extra,
Persian Jade,
Royal Gold



**V2
SLIGHT
VARIATION**
Carrara,
Silver Dream,
Noir St. Laurent



**V1
UNIFORM
VARIATION**
White Bevel,
Silver Bevel,
Black Bevel



SHINY SURFACE | SUPERFICIE LUCIDA | Surface brillante | Glänzende oberfläche | Superficie brillante | Глянec поверхность



AIX
WALL TILES

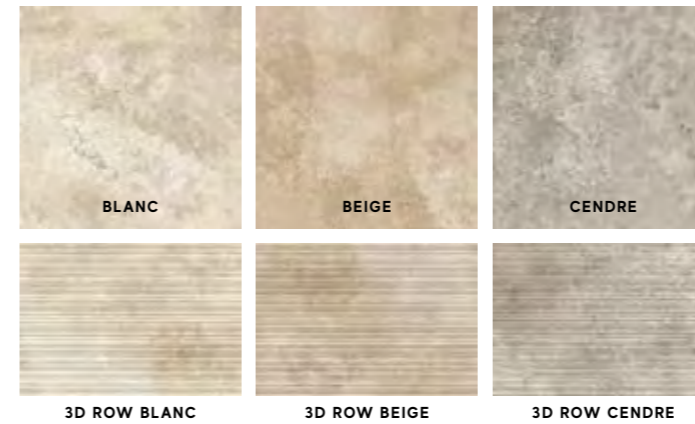

Wall Tiles / Rivestimento

WHITEBODY WALL TILES - RECTIFIED MONOCALIBER
RIVESTIMENTI IN PASTA BIANCA - RETTIFICATO MONOCALIBRO

COORDINATED PORCELAIN TILES p. 232

Sizes	Thickness	Surface finish
40x80 cm - 15 ³ / ₄ "x31 ¹ / ₂ "	± 8,5 mm	Matte

3D Wall Tiles

Sizes	Thickness	Surface finish
40x80 cm - 15 ³ / ₄ "x31 ¹ / ₂ "	± 10 mm	Matte

DECORATIVE RANGE / GAMMA DECORATIVA



MINIBRICK



WHITEBODY WALL TILES | RIVESTIMENTI IN PASTA BIANCA | Revêtements en pâte blanche | Weißscherbige Wandfliesen | Revestimientos en pasta blanca | Настенная плитка из белой глины
RECTIFIED MONOCALIBER | RETTIFICATO MONOCALIBRO | Rectifié mono-calibre | Geschliffen einkalibrig | Rectificado monocalibré | Ретицированный в одном калибре

Aix Wall Tiles / Rivestimento

MATTE SURFACE / SUPERFICIE MATT



8AIB Aix Blanc 40x80
40x80 cm - 15³/₄"x31¹/₂"



8A3B Aix 3D Row Blanc 40x80
40x80 cm - 15³/₄"x31¹/₂"



8AIE Aix Beige 40x80
40x80 cm - 15³/₄"x31¹/₂"



8A3E Aix 3D Row Beige 40x80
40x80 cm - 15³/₄"x31¹/₂"



8AIC Aix Cendre 40x80
40x80 cm - 15³/₄"x31¹/₂"



8A3C Aix 3D Row Cendre 40x80
40x80 cm - 15³/₄"x31¹/₂"



V2
SLIGHT
VARIATION
Blanc,
Beige,
Cendre

Aix Wall Tiles / Rivestimento

DECOR RANGE / GAMMA DECORI



9AKB Aix Blanc
Minibrick Tumbled *
30,5x30,5 - 12"x12"



9AKE Aix Beige
Minibrick Tumbled *
30,5x30,5 - 12"x12"



9AKC Aix Cendre
Minibrick Tumbled *
30,5x30,5 - 12"x12"

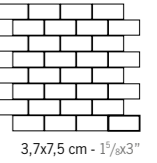

TRIM TILES / PEZZI SPECIALI

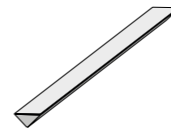

1,4x40 cm - 5/8"x15³/₄"

- LAII Aix Blanc Corner 40 *
- LAIC Aix Cendre Corner 40 *
- LAIE Aix Beige Corner 40 *
- LA3B Aix 3D Blanc Corner 40 *
- LA3C Aix 3D Cendre Corner 40 *
- LA3E Aix 3D Beige Corner 40 *



1,4x1,4 cm - 5/8"x5/8"

- A0IB Aix Blanc Corner A.E. 1,4 *
- A0IC Aix Cendre Corner A.E. 1,4 *
- A0IE Aix Beige Corner A.E. 1,4 *

* THESE PARTS ARE SUPPLIED TO ORDER . I PEZZI SONO DISPONIBILI SU ORDINAZIONE
Les pièces sont disponibles sur commande | Die Teile sind auf Bestellung lieferbar | Las piezas se hacen por encargo | Изготавливаются на заказ



* Tumbled / Burattato / Tamisé / Genarbt / Tamboreado / Выщербленный



atlas concorde

ARKSHADE

WALL TILES



Wall Tiles / Rivestimento

WHITEBODY WALL TILES - RECTIFIED MONOCALIBER
RIVESTIMENTI IN PASTA BIANCA - RETTIFICATO MONOCALIBRO

COORDINATED PORCELAIN TILES p. 108

Sizes	Thickness	Surface finish
40x80 cm - 15 ³ / ₄ "x31 ¹ / ₂ "	± 8,5 mm	Matte

3D Wall Tiles

Sizes	Thickness	Surface finish
40x80 cm - 15 ³ / ₄ "x31 ¹ / ₂ "	± 10 mm	Matte

DECORATIVE RANGE / GAMMA DECORATIVA



Arkshade Wall Tiles / Rivestimento

MATTE SURFACE / SUPERFICIE MATT



8DSO Solid White Matt
40x80 - 15³/₄"x31¹/₂"



8AKL Arkshade Light Clay 40X80
40x80 - 15³/₄"x31¹/₂"



8AKF Arkshade Sage 40X80
40x80 - 15³/₄"x31¹/₂"



8AKH Arkshade Sky 40X80
40x80 - 15³/₄"x31¹/₂"



8AKV Arkshade Light Dove 40X80
40x80 - 15³/₄"x31¹/₂"



8AKE Arkshade Deep Grey 40X80
40x80 - 15³/₄"x31¹/₂"



8AKN Arkshade Gemstone 40X80
40x80 - 15³/₄"x31¹/₂"



8AKU Arkshade Blue 40X80
40x80 - 15³/₄"x31¹/₂"

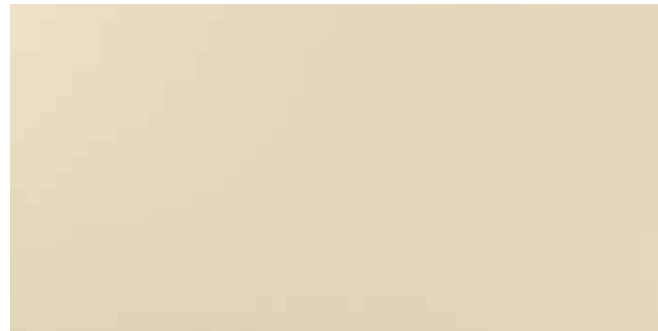

8AKA Arkshade Cream 40X80
40x80 - 15³/₄"x31¹/₂"



8AKP Arkshade Taupe 40X80
40x80 - 15³/₄"x31¹/₂"



8AKW Arkshade Yellow 40X80
40x80 - 15³/₄"x31¹/₂"



8AKD Arkshade Red 40X80
40x80 - 15³/₄"x31¹/₂"

TRIM TILES / PEZZI SPECIALI

LD8W Spigolo 8,5 mm White Matt
0,8x20 cm - 3¹/₈"x7⁷/₈"

A8DW Spigolo 8,5 mm A.E.
0,8x0,8 cm - 3¹/₈"x3¹/₈"

LAKD Arkshade Light Dove Spigolo
0,8x20 cm - 3¹/₈"x7⁷/₈"

AAKD Arkshade Light Dove Spigolo A.E.
0,8x0,8 cm - 3¹/₈"x3¹/₈"

LAKE Arkshade Cream Spigolo
0,8x20 cm - 3¹/₈"x7⁷/₈"

AAKE Arkshade Cream Spigolo A.E.
0,8x0,8 cm - 3¹/₈"x3¹/₈"

LAKC Arkshade Light Clay Spigolo
0,8x20 cm - 3¹/₈"x7⁷/₈"

AAKC Arkshade Light Clay Spigolo A.E.
0,8x0,8 cm - 3¹/₈"x3¹/₈"

LAKG Arkshade Deep Grey Spigolo
0,8x20 cm - 3¹/₈"x7⁷/₈"

AAKF Arkshade Deep Grey Spigolo A.E.
0,8x0,8 cm - 3¹/₈"x3¹/₈"

LAKT Arkshade Taupe Spigolo
0,8x20 cm - 3¹/₈"x7⁷/₈"

AAKT Arkshade Taupe Spigolo A.E.
0,8x0,8 cm - 3¹/₈"x3¹/₈"

TRIM TILES / PEZZI SPECIALI

LAKS Arkshade Sage Spigolo
0,8x20 cm - 3¹/₈"x7⁷/₈"

AAKS Arkshade Sage Spigolo A.E.
0,8x0,8 cm - 3¹/₈"x3¹/₈"

LAKO Arkshade Gemstone Spigolo
0,8x20 cm - 3¹/₈"x7⁷/₈"

AAKM Arkshade Gemstone Spigolo A.E.
0,8x0,8 cm - 3¹/₈"x3¹/₈"

LAKY Arkshade Yellow Spigolo
0,8x20 cm - 3¹/₈"x7⁷/₈"

AAKY Arkshade Yellow Spigolo A.E.
0,8x0,8 cm - 3¹/₈"x3¹/₈"

LAKK Arkshade Sky Spigolo
0,8x20 cm - 3¹/₈"x7⁷/₈"

AAKK Arkshade Sky Spigolo A.E.
0,8x0,8 cm - 3¹/₈"x3¹/₈"

LAKB Arkshade Blue Spigolo
0,8x20 cm - 3¹/₈"x7⁷/₈"

AAKB Arkshade Blue Spigolo A.E.
0,8x0,8 cm - 3¹/₈"x3¹/₈"

LAKR Arkshade Red Spigolo
0,8x20 cm - 3¹/₈"x7⁷/₈"

AAKR Arkshade Red Spigolo A.E.
0,8x0,8 cm - 3¹/₈"x3¹/₈"

**V1
UNIFORM
VARIATION**
Solid White,
Cream,
Taupe,
Light Clay,
Light Dove,
Deep Grey

**V1
UNIFORM
VARIATION**
Sage,
Sky,
Yellow,
Gemstone,
Blue,
Red

Arkshade 3D Wall Tiles / Rivestimento 3D

MATTE SURFACE / SUPERFICIE MATT



8ASC Arkshade 3D Stars Light Clay 40X80
40x80 - 15³/₄"x31¹/₂"



8ASD Arkshade 3D Stars Light Dove 40X80
40x80 - 15³/₄"x31¹/₂"



8ASB Arkshade 3D Stars Blue 40X80
40x80 - 15³/₄"x31¹/₂"



8ASY Arkshade 3D Stars Yellow 40X80
40x80 - 15³/₄"x31¹/₂"

TRIM TILES / PEZZI SPECIALI

- L1AC Arkshade Light Clay
Spigolo 10mm
0,8x20 cm - ³/₈"x7⁷/₈"
- L1AD Arkshade Light Dove
Spigolo 10mm
0,8x20 cm - ³/₈"x7⁷/₈"
- L1AB Arkshade Blue
Spigolo 10mm
0,8x20 cm - ³/₈"x7⁷/₈"
- L1AY Arkshade Yellow
Spigolo 10mm
0,8x20 cm - ³/₈"x7⁷/₈"



atlas concorde

The 10 mm edge matches three-dimensional wall tiles having a 10-11 mm thickness / Lo spigolo 10 mm si abbina a rivestimenti tridimensionali di spessore 10-11 mm / Le bord 10 mm s'adapte aux revêtements tridimensionnels épaisseur 10-11 mm / Die 10 mm Kante ist mit dreidimensionalen Wandfliesen mit einer Dicke von 10-11 mm kombinierbar / La arista de 10 mm se combina con revestimientos tridimensionales de 10 -11 mm de grosor / Угловой элемент 10 мм сочетается с трехмерной настенной плиткой толщиной 10-11 мм

MATTE SURFACE | SUPERFICIE MATT | Surface Mat | Matt Oberfläche | Superficie Mate | Матовая поверхность



Arkshade Wall Tiles / Rivestimento

DECOR RANGE / GAMMA DECORI

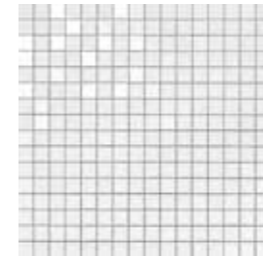

9DSM Solid White Mosaic
30,5x30,5 - 12"x12"

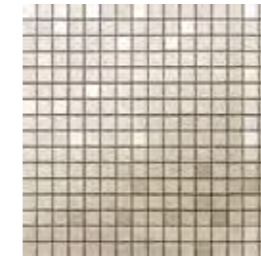

9AQL Arkshade Light Clay
Mosaico Q
30,5x30,5 - 12"x12"

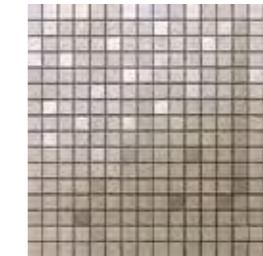

9AQD Arkshade Light Dove
Mosaico Q
30,5x30,5 - 12"x12"

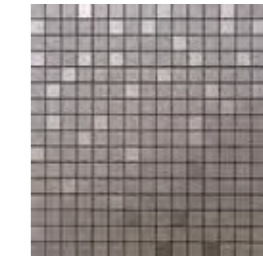

9AQE Arkshade Deep Grey
Mosaico Q
30,5x30,5 - 12"x12"

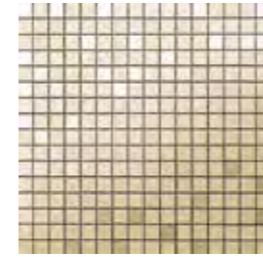
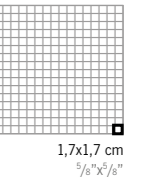

9AQM Arkshade Cream
Mosaico Q
30,5x30,5 - 12"x12"

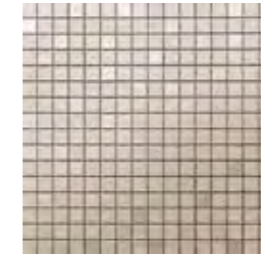

9AQP Arkshade Taupe
Mosaico Q
30,5x30,5 - 12"x12"

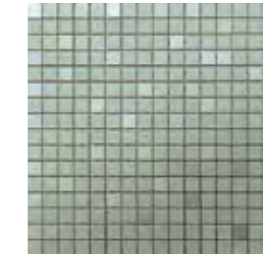

9AQS Arkshade Sage
Mosaico Q
30,5x30,5 - 12"x12"

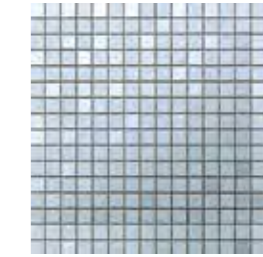

9AQK Arkshade Sky
Mosaico Q
30,5x30,5 - 12"x12"

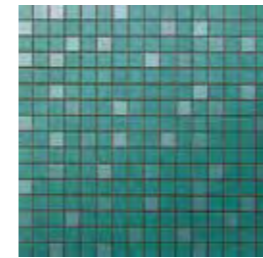

9AQT Arkshade Gemstone
Mosaico Q
30,5x30,5 - 12"x12"

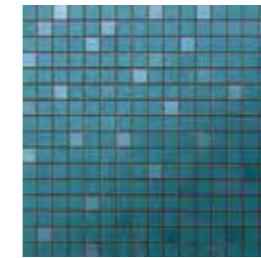

9AQU Arkshade Blue
Mosaico Q
30,5x30,5 - 12"x12"

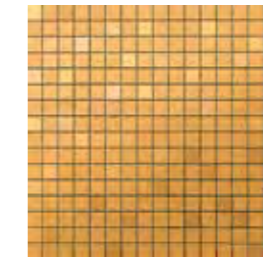

9AQY Arkshade Yellow
Mosaico Q
30,5x30,5 - 12"x12"

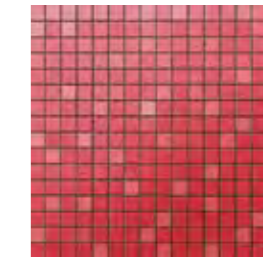

9AQR Arkshade Red
Mosaico Q
30,5x30,5 - 12"x12"



atlas concorde



V1 UNIFORM VARIATION

3D Stars Light, Clay,
3D Stars Light Dove,
3D Stars Blue,
3D Stars Yellow

Arkshade Wall Tiles / Rivestimento

DECOR RANGE / GAMMA DECORI



9AFC Arkshade Light Clay
Mosaico Flag
30,5x30,5 - 12"x12"



9AFD Arkshade Light Dove
Mosaico Flag
30,5x30,5 - 12"x12"



9AFG Arkshade Deep Grey
Mosaico Flag
30,5x30,5 - 12"x12"



9AFE Arkshade Cream
Mosaico Flag
30,5x30,5 - 12"x12"



9AFT Arkshade Taupe
Mosaico Flag
30,5x30,5 - 12"x12"

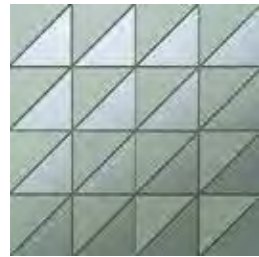

9AFS Arkshade Sage
Mosaico Flag
30,5x30,5 - 12"x12"

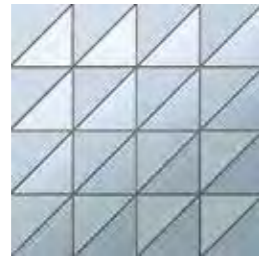

9AFK Arkshade Sky
Mosaico Flag
30,5x30,5 - 12"x12"

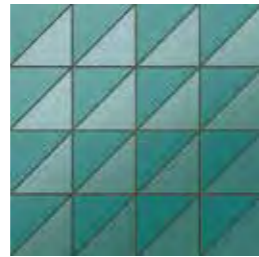

9AFM Arkshade Gemstone
Mosaico Flag
30,5x30,5 - 12"x12"

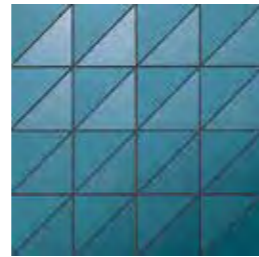

9AFB Arkshade Blue
Mosaico Flag
30,5x30,5 - 12"x12"

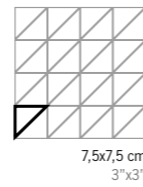

9AAE Arkshade Sage
Mosaico Sail
30,5x30,5 - 12"x12"



9AAK Arkshade Sky
Mosaico Sail
30,5x30,5 - 12"x12"



9AAG Arkshade Gemstone
Mosaico Sail
30,5x30,5 - 12"x12"

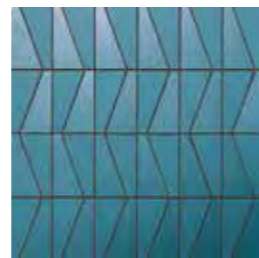

9AAB Arkshade Blue
Mosaico Sail
30,5x30,5 - 12"x12"



8ADW Arkshade White Drops •
40x80 - 15 3/4"x31 1/2"



8ATW Arkshade White Trace •
40x80 - 15 3/4"x31 1/2"



8ADT Arkshade Taupe Drops •
40x80 - 15 3/4"x31 1/2"

• **DECOR WITH GOLD INSERT.**
DECORO CON INSERTO IN ORO.
Décor avec insert en OR.
Dekor mit Einlage GOLD.
Decoración con aplicación de ORO.
Декор с ЗОЛОТОЙ вставкой.





ARTY

WALL TILES

Wall Tiles / Rivestimento

WHITEBODY WALL TILES - RECTIFIED MONOCALIBER
RIVESTIMENTI IN PASTA BIANCA - RETTIFICATO MONOCALIBRO



Sizes	Thickness	Surface finish
40x80 cm - 15 ³ / ₄ "x31 ¹ / ₂ "	± 8,5 mm	Matte

3D Wall Tiles

Sizes	Thickness	Surface finish
40x80 cm - 15 ³ / ₄ "x31 ¹ / ₂ "	± 10 mm	Matte

DECORATIVE RANGE / GAMMA DECORATIVA



WHITEBODY WALL TILES | RIVESTIMENTI IN PASTA BIANCA | Revêtements en pâte blanche | Weißscherbige Wandfliesen | Revestimientos en pasta blanca | Настенная плитка из белой глины
RECTIFIED MONOCALIBER | RETTIFICATO MONOCALIBRO | Rectifié mono-calibre | Geschliffen einkalibrig | Rectificado monocalibre | Ретицированный в одном калибре

Arty Wall Tiles / Rivestimento

MATTE SURFACE / SUPERFICIE MATT

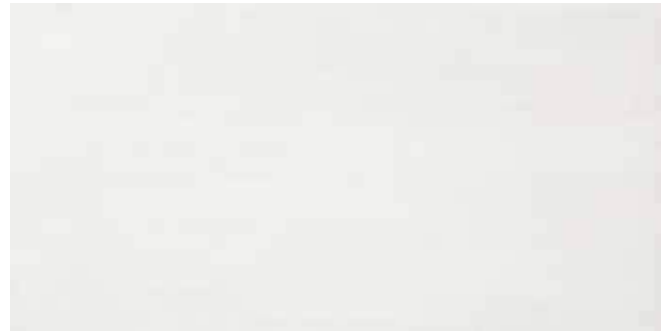

SARU Arty Sugar 40X80
40x80 - 15³/₄"x31¹/₂"



SARL Arty Milk 40X80
40x80 - 15³/₄"x31¹/₂"



SARA Arty Charcoal 40X80
40x80 - 15³/₄"x31¹/₂"



SARN Arty Malt 40X80
40x80 - 15³/₄"x31¹/₂"



SARD Arty Curry 40X80
40x80 - 15³/₄"x31¹/₂"



SARB Arty Tabasco 40X80
40x80 - 15³/₄"x31¹/₂"

TRIM TILES / PEZZI SPECIALI

LASS Arty Sugar Spigolo
0,8x20 - 3¹/₈"x7⁷/₈"

AASS Spigolo A.E.
0,8x0,8 - 3¹/₈"x3¹/₈"

LASH Arty Charcoal Spigolo
0,8x20 - 3¹/₈"x7⁷/₈"

AASH Spigolo A.E.
0,8x0,8 - 3¹/₈"x3¹/₈"

LASC Arty Curry Spigolo
0,8x20 - 3¹/₈"x7⁷/₈"

AASU Spigolo A.E.
0,8x0,8 - 3¹/₈"x3¹/₈"

LASK Arty Milk Spigolo
0,8x20 - 3¹/₈"x7⁷/₈"

AASI Spigolo A.E.
0,8x0,8 - 3¹/₈"x3¹/₈"

LASD Arty Malt Spigolo
0,8x20 - 3¹/₈"x7⁷/₈"

AASM Spigolo A.E.
0,8x0,8 - 3¹/₈"x3¹/₈"

LASO Arty Tabasco Spigolo
0,8x20 - 3¹/₈"x7⁷/₈"

AASO Spigolo A.E.
0,8x0,8 - 3¹/₈"x3¹/₈"



Arty 3D Wall Tiles / Rivestimento 3D

MATTE SURFACE / SUPERFICIE MATT



8AWS Arty Sugar Wave 40X80
40x80 - 15³/₄"x31¹/₂"



8AWM Arty Milk Wave 40X80
40x80 - 15³/₄"x31¹/₂"

DECOR RANGE / GAMMA DECORI



9ASS Arty Sugar Minibrick
30,5x30,5 - 12"x12"



9ASH Arty Charcoal Minibrick
30,5x30,5 - 12"x12"



9ASC Arty Curry Minibrick
30,5x30,5 - 12"x12"



9ASI Arty Milk Minibrick
30,5x30,5 - 12"x12"



9ASM Arty Malt Minibrick
30,5x30,5 - 12"x12"



9AST Arty Tabasco Minibrick
30,5x30,5 - 12"x12"

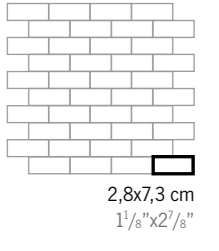

2,8x7,3 cm
1 1/8" x 2 7/8"



MATTE SURFACE | SUPERFICIE MATT | Surface Mat | Matt oberfläche | Superficie Mate | Матовая поверхность



V1 UNIFORM VARIATION

Sugar,
Milk,
Charcoal,
Malt,
Curry,
Tabasco



V1 UNIFORM VARIATION

3D Wave Sugar,
3D Wave Milk

Arty Wall Tiles / Rivestimento

DECOR RANGE / GAMMA DECORI



SATM Arty Milk Texture
40x80 - 15³/₄"x31¹/₂"



8ATT Arty Tabasco Texture
40x80 - 15³/₄"x31¹/₂"



8A2S Arty Sugar Urban C2
80x80 - 31¹/₂"x31¹/₂"



8A2C Arty Curry Urban C2
80x80 - 31¹/₂"x31¹/₂"



8A2T Arty Tabasco Urban C2
80x80 - 31¹/₂"x31¹/₂"



Arty Wall tiles / Rivestimento

MATCHING FLOOR / PAVIMENTI CONSIGLIATI

	Sugar	Milk	Malt	Charcoal	Curry	Tabasco	
WOOD LOOK							
			ETIC				
			Rovere Bianco		Rovere Grigio	Rovere Bianco	
			Rovere Grigio			Rovere Grigio	
	NASH	Gray Wood	White Wood	White Wood	White Wood	Gray Wood	Gray Wood
	ETIC PRO	Rovere Venice	Rovere Venice	Rovere Venice		Rovere Venice	
ARBOR	Natural	Cognac	Cognac	Natural	Almond		
CONCRETE LOOK							
	BOOST	White	Pearl	Pearl	White	Pearl	White
					Smoke	Pearl	
	ARKSHADE	White			Clay	Clay	White
		Grey					
DWELL							
	Gray						
	Pearl					Smoke	



BLAZE

WALL TILES

Wall Tiles / Rivestimento

WHITEBODY WALL TILES - RECTIFIED MONOCALIBER
RIVESTIMENTI IN PASTA BIANCA - RETTIFICATO MONOCALIBRO

COORDINATED PORCELAIN TILES p. 100

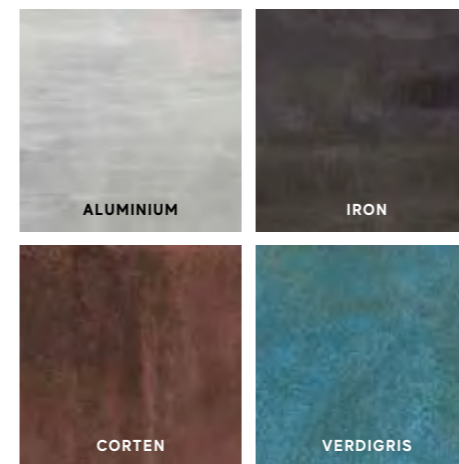

Sizes	Thickness	Surface finish
50x110 cm - 19 ⁵ / ₈ "x43 ¹ / ₄ "	± 8,5 mm	Matte

DECORATIVE RANGE / GAMMA DECORATIVA

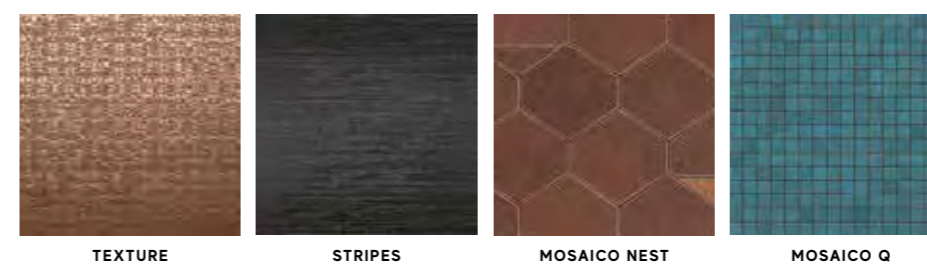

WHITEBODY WALL TILES | RIVESTIMENTI IN PASTA BIANCA | Revêtements en pâte blanche | Weißscherbige Wandfliesen | Revestimientos en pasta blanca | Настенная плитка из белой глины
RECTIFIED MONOCALIBER | RETTIFICATO MONOCALIBRO | Rectifié mono-calibre | Geschliffen einkalbrig | Rectificado monocalibr | Ретицированный в одном калибре

Blaze Wall Tiles / Rivestimento

MATTE SURFACE / SUPERFICIE MATT



4B1A Blaze Aluminium 50x110
50x110 cm - 19 5/8" x 43 3/4"



4B1R Blaze Iron 50x110
50x110 cm - 19 5/8" x 43 3/4"



4B1C Blaze Corten 50x110
50x110 cm - 19 5/8" x 43 3/4"



4B1V Blaze Verdigris 50x110
50x110 cm - 19 5/8" x 43 3/4"



V3
MODERATE
VARIATION
Aluminium,
Corten,
Iron,
Verdigris



atlas concorde

MATTE SURFACE | SUPERFICIE MATT | Surface Mat | Matt oberfläche | Superficie Mate | Матовая поверхность

Blaze Wall Tiles / Rivestimento

DECOR RANGE / GAMMA DECORI

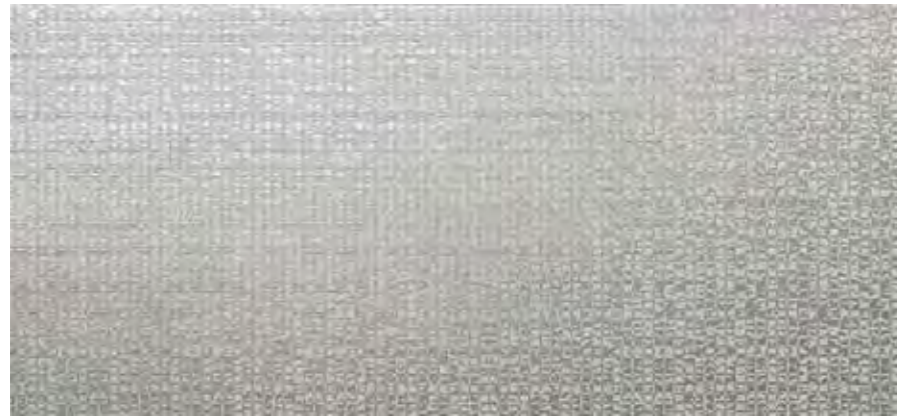

4BTA Blaze Aluminium Texture 110
50x110 cm - 19⁵/₈"x43³/₄"



4BTC Blaze Corten Texture 110
50x110 cm - 19⁵/₈"x43³/₄"

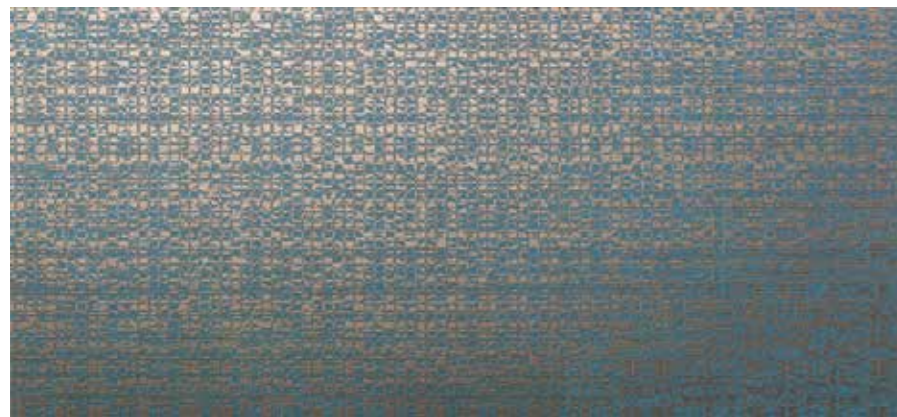

4BTV Blaze Verdigris Texture 110
50x110 cm - 19⁵/₈"x43³/₄"



4B3A Blaze Iron Stripes 50x110
50x110 cm - 19⁵/₈"x43³/₄"



9BNA Blaze Aluminium
Mosaico Nest •
29,4x25,8 - 11⁵/₈"x10¹/₈"



9BNC Blaze Corten
Mosaico Nest •
29,4x25,8 - 11⁵/₈"x10¹/₈"



9BNI Blaze Iron
Mosaico Nest •
29,4x25,8 - 11⁵/₈"x10¹/₈"



9BNV Blaze Verdigris
Mosaico Nest •
29,4x25,8 - 11⁵/₈"x10¹/₈"

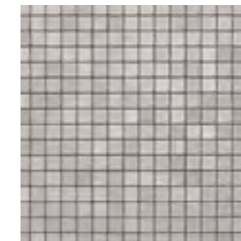

9BQA Blaze Aluminium
Mos Q
30,5x30,5 - 12"x12"



9BQC Blaze Corten
Mos Q
30,5x30,5 - 12"x12"

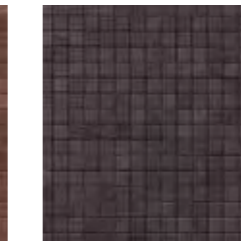

9BQI Blaze Iron
Mos Q
30,5x30,5 - 12"x12"

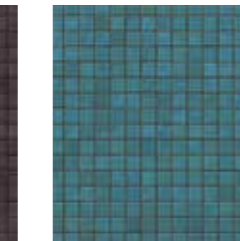

9BQV Blaze Verdigris
Mos Q
30,5x30,5 - 12"x12"

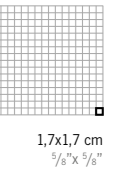
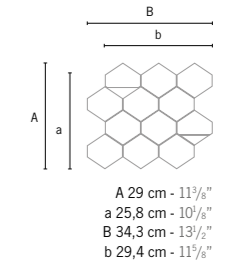

TRIM TILES / PEZZI SPECIALI

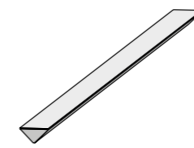

1,4x50 cm - 5/8"x19⁵/₈"
LB5M Blaze Aluminium Corner 50 •
LB5C Blaze Corten Corner 50 •
LB5R Blaze Iron Corner 50 •
LB5V Blaze Verdigris Corner 50 •
LB5S Blaze Iron Stripes Corner 50 •



1,4x1,4 cm - 5/8"x5/8"
A0LA Blaze Aluminium Corner A.E. 1,4 •
A0LC Blaze Corten Corner A.E. 1,4 •
A0LR Blaze Iron Corner A.E. 1,4 •
A0LV Blaze Verdigris Corner A.E. 1,4 •
A0LS Blaze Iron Stripes Corner A.E. 1,4 •

- **Application of decorative materials. The use of a common mild detergent is recommended. Avoid using acidic or alkaline products, waxes, steel wool, or abrasives.** / Applicazione di materie decorative. Si consiglia l'utilizzo di un comune detergente neutro. Evitare l'utilizzo di prodotti acidi o alcalini, ceranti e pagliette di metallo o abrasive. / Application de matériaux décoratifs. Nous conseillons l'emploi de détergents neutres courants. Éviter l'utilisation de cires et de produits acides ou alcalins, ainsi que les pailles métalliques ou abrasives. / Dekorationsmaterial. Es empfiehlt sich, ein haushaltsübliches, neutrales Reinigungsmittel zu verwenden. Saure oder alkalische Produkte, Wachs sowie Stahlwolle- bzw. Scheuerschwämme sind zu vermeiden. / Aplicación de materiales decorativos. Recomendamos utilizar un detergente neutro común. Hay que evitar el uso de productos ácidos o alcalinos, ceras y estropajos de metal o abrasivos. / Применение декоративных материалов. Рекомендуется чистить обычным нейтральным моющим средством. Не рекомендуется использовать кислотные, щелочные, восковые средства, а также металлические мочалки.

• **THESE PARTS ARE SUPPLIED TO ORDER . I PEZZI SONO DISPONIBILI SU ORDINAZIONE**
Les pièces sont disponibles sur commande | Die Teile sind auf Bestellung lieferbar | Las piezas se hacen por encargo | Изготавливаются на заказ



atlas concorde

BOOST

WALL TILES



Wall Tiles / Rivestimento

WHITEBODY WALL TILES - RECTIFIED MONOCALIBER
RIVESTIMENTI IN PASTA BIANCA - RETTIFICATO MONOCALIBRO

COORDINATED PORCELAIN TILES p. 120

Sizes	Thickness	Surface finish
40x80 cm - 15 ³ / ₄ "x31 ¹ / ₂ "	± 8,5 mm	Matte

3D Wall Tiles

Sizes	Thickness	Surface finish
40x80 cm - 15 ³ / ₄ "x31 ¹ / ₂ "	± 10 mm	Matte

DECORATIVE RANGE / GAMMA DECORATIVA



MINIBRICK



atlas concorde

WHITEBODY WALL TILES | RIVESTIMENTI IN PASTA BIANCA | Revêtements en pâte blanche | Weißscherbige Wandfliesen | Revestimientos en pasta blanca | Настенная плитка из белой глины
RECTIFIED MONOCALIBER | RETTIFICATO MONOCALIBRO | Rectifié mono-calibre | Geschliffen einkalibrig | Rectificado monocalibré | Ретицированный в одном калибре

Boost Wall Tiles / Rivestimento

MATTE SURFACE / SUPERFICIE MATT



8B8W Boost White 40x80
40x80 - 15³/₄"x31¹/₂"



8B8P Boost Pearl 40x80
40x80 - 15³/₄"x31¹/₂"



8B8G Boost Grey 40x80
40x80 - 15³/₄"x31¹/₂"



8B8K Boost Smoke 40x80
40x80 - 15³/₄"x31¹/₂"



8B8S Boost Sage 40x80
40x80 - 15³/₄"x31¹/₂"



8B8R Boost Red 40x80
40x80 - 15³/₄"x31¹/₂"

TRIM TILES / PEZZI SPECIALI

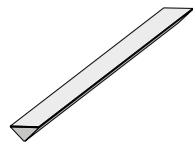

- 1,4x40 cm - 5/8"x15³/₄"
- LBBW Boost White Corner 40
 - LBBP Boost Pearl Corner 40
 - LBBY Boost Grey Corner 40
 - LBBH Boost Smoke Corner 40
 - LBBT Boost Sage Corner 40
 - LBBQ Boost Red Corner 40



- 1,4x1,4 cm - 5/8"x5/8"
- A0AW Boost White Corner A.E.
 - A0AP Boost Pearl Corner A.E.
 - A0AG Boost Grey Corner A.E.
 - A0AK Boost Smoke Corner A.E.
 - A0AS Boost Sage Corner A.E.
 - A0AR Boost Red Corner A.E.

3D TRIM TILES / PEZZI SPECIALI 3D



- 1,4x40 cm - 5/8"x15³/₄"
- LB3W Boost White 3D Corner 40
 - LB3P Boost Pearl 3D Corner 40
 - LB3G Boost Grey 3D Corner 40



Boost 3D Wall Tiles / Rivestimento 3D

MATTE SURFACE / SUPERFICIE MATT



8BUW Boost 3D Urban White 40x80
40x80 - 15³/₄"x31¹/₂"



8BUP Boost 3D Urban Pearl 40x80
40x80 - 15³/₄"x31¹/₂"

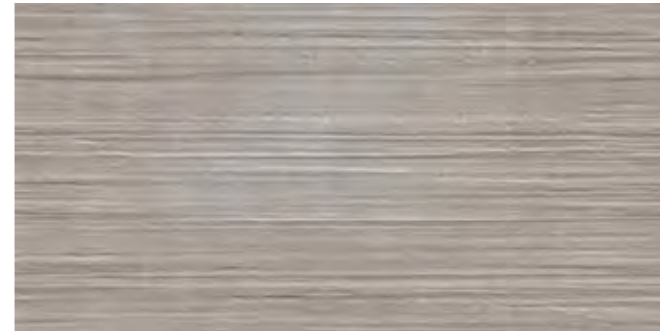

8BUG Boost 3D Urban Grey 40x80
40x80 - 15³/₄"x31¹/₂"

DECOR RANGE / GAMMA DECORI



9BMW Boost White Minibrick
30,5x30,5 - 12"x12"



9BME Boost Pearl Minibrick
30,5x30,5 - 12"x12"



9BMY Boost Grey Minibrick
30,5x30,5 - 12"x12"



9BMK Boost Smoke Minibrick
30,5x30,5 - 12"x12"



9BMM Boost Sage Minibrick
30,5x30,5 - 12"x12"



9BMQ Boost Red Minibrick
30,5x30,5 - 12"x12"

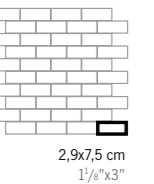

2,9x7,5 cm
1¹/₈"x3"



V2
SLIGHT
VARIATION

White,
Pearl,
Grey,
Smoke,
Sage,
Red



V2
SLIGHT
VARIATION

3D Urban White,
3D Urban Pearl,
3D Urban Grey

* THESE PARTS ARE SUPPLIED TO ORDER . I PEZZI SONO DISPONIBILI SU ORDINAZIONE
Les pièces sont disponibles sur commande | Die Teile sind auf Bestellung lieferbar | Las piezas se hacen por encargo | Изготавливаются на заказ

MATTE SURFACE | SUPERFICIE MATT | Surface Mat | Matt oberfläche | Superficie Mate | Матовая поверхность

MATTE SURFACE | SUPERFICIE MATT | Surface Mat | Matt oberfläche | Superficie Mate | Матовая поверхность



atlas concorde

brave
WALL TILES



DECORATIVE RANGE / GAMMA DECORATIVA



MOSAIC

Wall Tiles / Rivestimento

WHITEBODY WALL TILES - RECTIFIED MONOCALIBER
RIVESTIMENTI IN PASTA BIANCA - RETTIFICATO MONOCALIBRO

COORDINATED PORCELAIN TILES p. 242

Sizes	Thickness	Surface finish
40x80 cm - 15 ³ / ₄ "x31 ¹ / ₂ "	± 8,5 mm	Matte

3D Wall Tiles

Sizes	Thickness	Surface finish
40x80 cm - 15 ³ / ₄ "x31 ¹ / ₂ "	± 10 mm	Matte



atlas concorde

Brave Wall Tiles / Rivestimento

MATTE SURFACE / SUPERFICIE MATT



8BWU Brave Gypsum 40x80
40x80 cm - 15³/₄"x31¹/₂"



8BWL Brave Pearl 40x80
40x80 cm - 15³/₄"x31¹/₂"



8BWW Brave Grey 40x80
40x80 cm - 15³/₄"x31¹/₂"

TRIM TILES / PEZZI SPECIALI

LBSU Brave Gypsum Spigolo 0,8
0,8x20 cm - ³/₈"x7⁷/₈"

A1BU Brave Gypsum Spigolo 0,8 A.E.
0,8x0,8 cm - ³/₈"x³/₈"

LBSL Brave Pearl Spigolo 0,8
0,8x20 cm - ³/₈"x7⁷/₈"

A1BL Brave Pearl Spigolo 0,8 A.E.
0,8x0,8 cm - ³/₈"x³/₈"

LBSE Brave Grey Spigolo 0,8
0,8x20 cm - ³/₈"x7⁷/₈"

A1BR Brave Grey Spigolo 0,8 A.E.
0,8x0,8 cm - ³/₈"x³/₈"

DECOR RANGE / GAMMA DECORI



9BBG Brave Gypsum Mosaic
30,5x30,5 - 12"x12"



9BBP Brave Pearl Mosaic
30,5x30,5 - 12"x12"



9BBE Brave Grey Mosaic
30,5x30,5 - 12"x12"

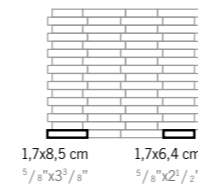

V2
SLIGHT
VARIATION
Gypsum,
Pearl,
Grey

Brave 3D Wall Tiles / Rivestimento 3D

MATTE SURFACE / SUPERFICIE MATT



8BDG Brave 3D/Wave Gypsum 40x80
40x80 cm - 15³/₄"x31¹/₂"



8BDP Brave 3D/Wave Pearl 40x80
40x80 cm - 15³/₄"x31¹/₂"



8BBG Brave 3D/Blade Gypsum 40x80
40x80 cm - 15³/₄"x31¹/₂"



8BDE Brave 3D/Wave Grey 40x80
40x80 cm - 15³/₄"x31¹/₂"

TRIM TILES / PEZZI SPECIALI

LB1G Brave Gypsum Spigolo 10mm *
1x20 cm - ³/₈"x7⁷/₈"

LB1R Brave Pearl Spigolo 10mm *
1x20 cm - ³/₈"x7⁷/₈"

LB1E Brave Grey Spigolo 10mm *
1x20 cm - ³/₈"x7⁷/₈"

* THESE PARTS ARE SUPPLIED TO ORDER. I PEZZI SONO DISPONIBILI SU ORDINAZIONE
Les pièces sont disponibles sur commande | Die Teile sind auf Bestellung lieferbar | Las piezas se hacen por encargo | Изготавливаются на заказ



V2
SLIGHT
VARIATION
3D Wave Gypsum,
3D Blade Gypsum,
3D Wave Pearl,
3D Wave Grey

The 10 mm edge matches three-dimensional wall tiles having a 10-11 mm thickness / Lo spigolo 10 mm si abbina a rivestimenti tridimensionali di spessore 10-11 mm / Le bord 10 mm s'adapte aux revêtements tridimensionnels épaisseur 10-11 mm / Die 10 mm Kante ist mit dreidimensionalen Wandfliesen mit einer Dicke von 10-11 mm kombinierbar / La arista de 10 mm se combina con revestimientos tridimensionales de 10-11 mm de grosor / Угловой элемент 10 мм сочетается с трехмерной настенной плиткой толщиной 10-11 мм

MATTE SURFACE | SUPERFICIE MATT | Surface Mat | Matt oberfläche | Superficie Mate | Матовая поверхность



atlas concorde

dwell

WALL TILES

Wall Tiles / Rivestimento

WHITEBODY WALL TILES - RECTIFIED MONOCALIBER
RIVESTIMENTI IN PASTA BIANCA - RETTIFICATO MONOCALIBRO

COORDINATED PORCELAIN TILES p. 130

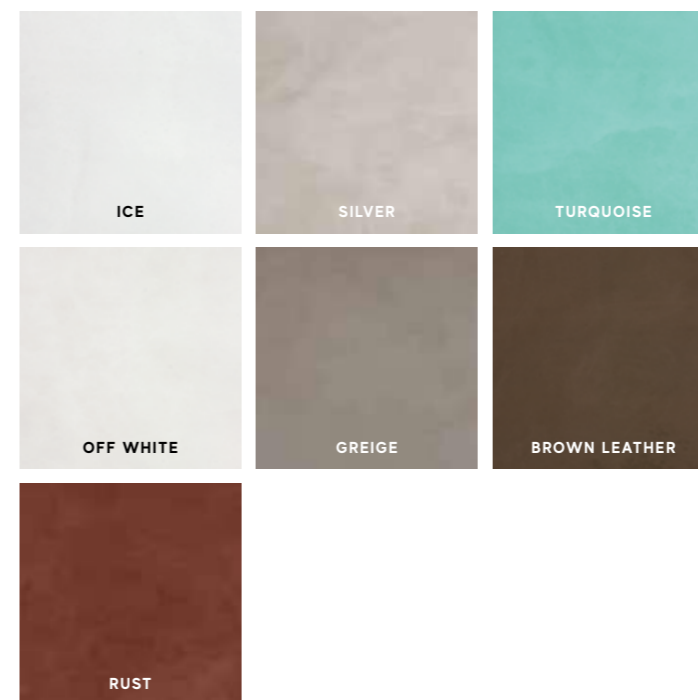

Sizes	Thickness	Surface finish
50x110 cm - 19 ⁵ / ₈ "x43 ¹ / ₄ "	± 8,5 mm	Shiny
40x80 cm - 15 ³ / ₄ "x31 ¹ / ₂ "	± 8,5 mm	Shiny

DECORATIVE RANGE / GAMMA DECORATIVA

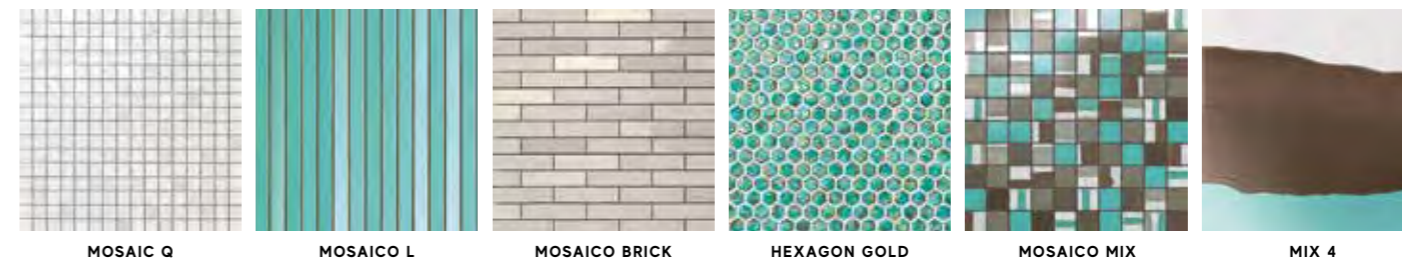

WHITEBODY WALL TILES | RIVESTIMENTI IN PASTA BIANCA | Revêtements en pâte blanche | Weißscherbige Wandfliesen | Revestimientos en pasta blanca | Настенная плитка из белой глины
RECTIFIED MONOCALIBER | RETTIFICATO MONOCALIBRO | Rectifié mono-calibre | Geschliffen einkalibrig | Rectificado monocalibre | Ретифицированный в одном калибре

Dwell Wall Tiles / Rivestimento

SHINY SURFACE / SUPERFICIE LUCIDA



4D1W Dwell Off White 110
50x110 cm - 19⁵/₈"x43³/₄"

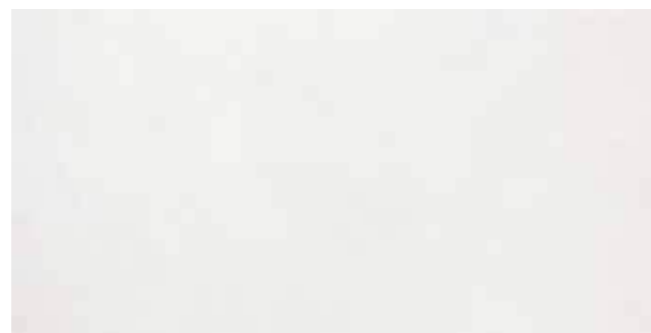

8DWH Dwell Off White 40x80
40x80 cm - 15³/₄"x31¹/₂"



4D1I Dwell Ice 110
50x110 cm - 19⁵/₈"x43³/₄"



8DWC Dwell Ice 40x80
40x80 cm - 15³/₄"x31¹/₂"



4D1R Dwell Greige 110
50x110 cm - 19⁵/₈"x43³/₄"



8DWD Dwell Greige 40x80
40x80 cm - 15³/₄"x31¹/₂"



4D1V Dwell Silver 110
50x110 cm - 19⁵/₈"x43³/₄"



8DWL Dwell Silver 40x80
40x80 cm - 15³/₄"x31¹/₂"



4D1B Dwell Brown Leather 110
50x110 cm - 19⁵/₈"x43³/₄"



8DWO Dwell Brown Leather 40x80
40x80 cm - 15³/₄"x31¹/₂"



4D1T Dwell Turquoise 110
50x110 cm - 19⁵/₈"x43³/₄"



8DWQ Dwell Turquoise 40x80
40x80 cm - 15³/₄"x31¹/₂"



4D1U Dwell Rust 110
50x110 cm - 19⁵/₈"x43³/₄"



8DWA Dwell Rust 40x80
40x80 cm - 15³/₄"x31¹/₂"

TRIM TILES / PEZZI SPECIALI

LDPI Dwell Ice Spigolo
0,8x20 cm - 3¹/₈"x7⁷/₈"

LDPS Dwell Silver Spigolo
0,8x20 cm - 3¹/₈"x7⁷/₈"

LDPT Dwell Turquoise Spigolo
0,8x20 cm - 3¹/₈"x7⁷/₈"

LDPW Dwell Off White Spigolo
0,8x20 cm - 3¹/₈"x7⁷/₈"

A1DI Dwell Ice Spigolo A.E.
0,8x0,8 cm - 3¹/₈"x3¹/₈"

A1DS Dwell Silver Spigolo A.E.
0,8x0,8 cm - 3¹/₈"x3¹/₈"

A1DT Dwell Turquoise Spigolo A.E.
0,8x0,8 cm - 3¹/₈"x3¹/₈"

A1DW Dwell Off White Spigolo A.E.
0,8x0,8 cm - 3¹/₈"x3¹/₈"

LDPR Dwell Greige Spigolo
0,8x20 cm - 3¹/₈"x7⁷/₈"

LDPO Dwell Brown Leather Spigolo
0,8x20 cm - 3¹/₈"x7⁷/₈"

LDPU Dwell Rust Spigolo
0,8x20 cm - 3¹/₈"x7⁷/₈"

A1DG Dwell Greige Spigolo A.E.
0,8x0,8 cm - 3¹/₈"x3¹/₈"

A1DB Dwell Brown Leather Spigolo A.E.
0,8x0,8 cm - 3¹/₈"x3¹/₈"

A1DR Dwell Rust Spigolo A.E.
0,8x0,8 cm - 3¹/₈"x3¹/₈"



V2 SLIGHT VARIATION
Off White,
Greige,
Brown Leather,
Rust,
Ice,
Silver,
Turquoise

SHINY SURFACE | SUPERFICIE LUCIDA | Surface brillante | Glänzende oberfläche | Superficie brillante | Глянцевая поверхность

Dwell Wall Tiles / Rivestimento

DECOR RANGE / GAMMA DECORI

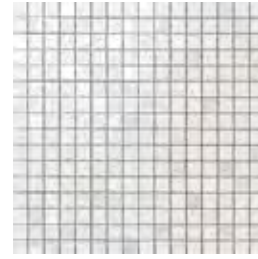

9DQI Dwell Ice Mosaico Q
30,5x30,5 - 12"x12"

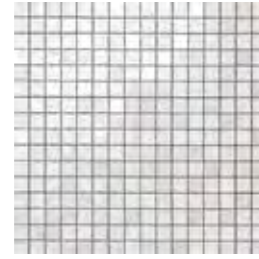

9DQW Dwell Off White Mosaico Q
30,5x30,5 - 12"x12"

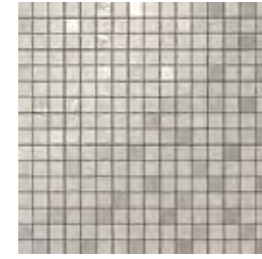

9DQS Dwell Silver Mosaico Q
30,5x30,5 - 12"x12"

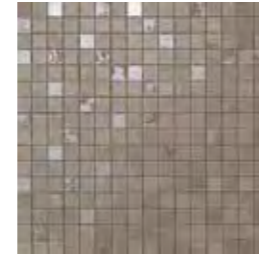

9DQG Dwell Greige Mosaico Q
30,5x30,5 - 12"x12"

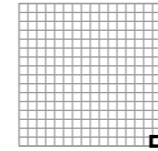

1,7x1,7 cm
5/8"x5/8"



9DQB Dwell Brown Leather Mosaico Q
30,5x30,5 - 12"x12"



9DQR Dwell Rust Mosaico Q
30,5x30,5 - 12"x12"

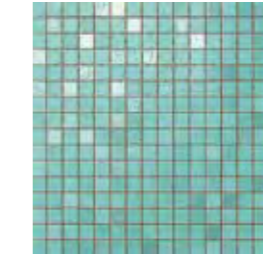

9DQT Dwell Turquoise Mosaico Q
30,5x30,5 - 12"x12"



9DLI Dwell Ice Mosaico L
30,5x26 - 12"x10 1/4"



9DLW Dwell Off White Mosaico L
30,5x26 - 12"x10 1/4"

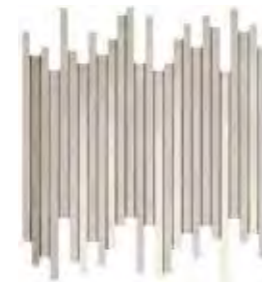

9DLS Dwell Silver Mosaico L
30,5x26 - 12"x10 1/4"



9DLG Dwell Greige Mosaico L
30,5x26 - 12"x10 1/4"

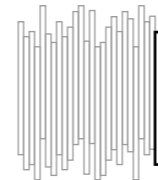

1x26 cm
3/8"x10 1/4"



9DLB Dwell Brown Leather Mosaico L
30,5x26 - 12"x10 1/4"



9DLR Dwell Rust Mosaico L
30,5x26 - 12"x10 1/4"

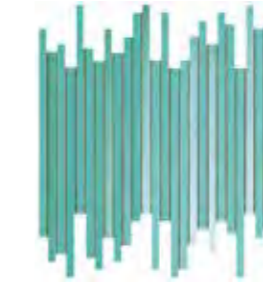

9DLT Dwell Turquoise Mosaico L
30,5x26 - 12"x10 1/4"



9DBV Dwell Silver Mosaico Brick
30,5x30,5 - 12"x12"



9DBR Dwell Greige Mosaico Brick
30,5x30,5 - 12"x12"

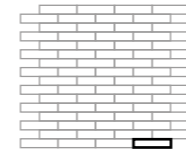

1,7x7,4 cm
5/8"x2 7/8"

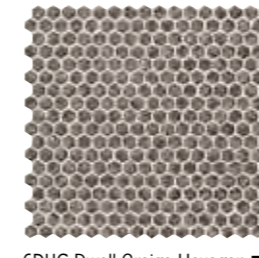

6DHG Dwell Greige Hexagon ■
30x28,5 - 11 3/4"x11 1/4"

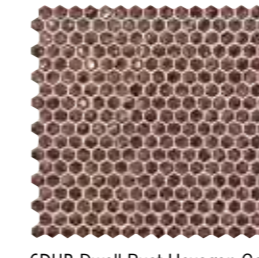

6DHR Dwell Rust Hexagon Gold ■
30x28,5 - 11 3/4"x11 1/4"

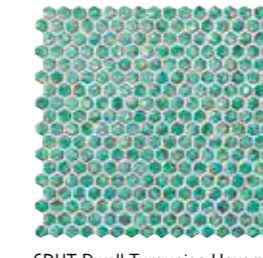

6DHT Dwell Turquoise Hexagon Gold ■
30x28,5 - 11 3/4"x11 1/4"

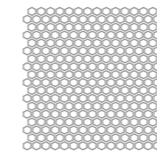

0,9 cm
3/8"

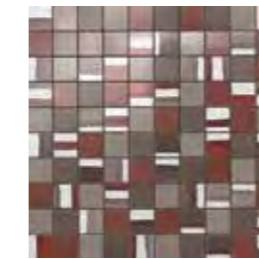

9DMR Dwell Rust Mosaico Mix
30,5x30,5 - 12"x12"

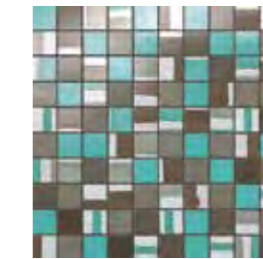

9DMT Dwell Turquoise Mosaico Mix
30,5x30,5 - 12"x12"



6DMR Dwell Rust Mix 4
20x40 - 7 7/8"x15 3/4"



6DMU Dwell Turquoise Mix 4
20x40 - 7 7/8"x15 3/4"

■ ENGRAVED MOSAIC WITH PROFILED EDGES.
MOSAICO INCISO CON BORDI SAGOMATI.
Mosaïque gravé avec bords bombés.
Mosaik graviert mit profilierten Kanten.
Mosaico grabado con bordes perfilados.
Высеченная мозаика с фасонными кромками.

• DECOR WITH GOLD INSERT.
DECORO CON INSERTO IN ORO.
Décor avec insert en OR.
Dekor mit Einlage GOLD.
Decoración con aplicación de ORO.
Декор с ЗОЛОТОЙ вставкой.



eWALL
WALL TILES

Wall Tiles / Rivestimento

COLOURED BODY PORCELAIN TILES - RECTIFIED MONOCALIBER
GRES PORCELLANATO COLORATO IN MASSA - RETTIFICATO MONOCALIBRO

COORDINATED PORCELAIN TILES p. 140



Sizes	Thickness	Surface finish
40x80 cm - 15 ³ / ₄ "x31 ¹ / ₂ "	± 8 mm	Matte

DECORATIVE RANGE / GAMMA DECORATIVA

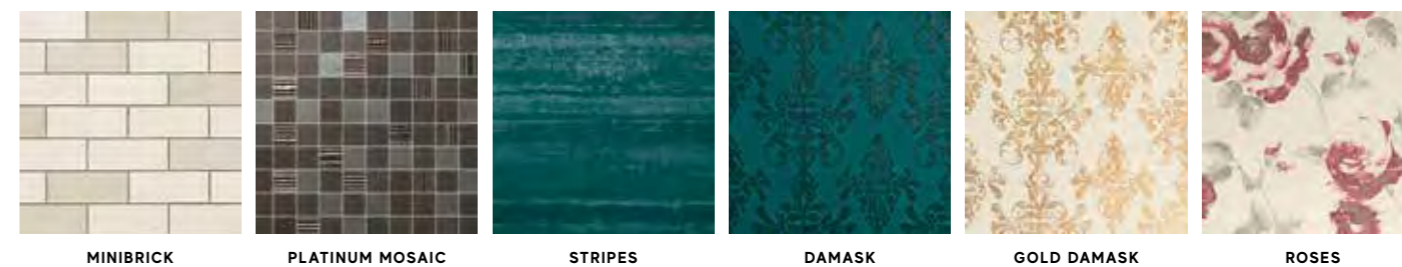

Ewall Wall Tiles / Rivestimento

MATTE SURFACE / SUPERFICIE MATT



8E4L Ewall Pure 40X80
40x80 - 15³/₄"x31¹/₂"



8E4D Ewall Concrete 40X80
40x80 - 15³/₄"x31¹/₂"



8E4H Ewall Night 40X80
40x80 - 15³/₄"x31¹/₂"



8E4B Ewall Amethyst 40X80
40x80 - 15³/₄"x31¹/₂"



8E4F Ewall Petroleum Green 40X80
40x80 - 15³/₄"x31¹/₂"

TRIM TILES / PEZZI SPECIALI

LESP Ewall Pure Spigolo
0,8x20 - 3¹/₈"x7¹/₈"

AESP Spigolo A.E.
0,8x0,8 - 3¹/₈"x3¹/₈"

LESA Ewall Amethyst Spigolo
0,8x20 - 3¹/₈"x7¹/₈"

AESA Spigolo A.E.
0,8x0,8 - 3¹/₈"x3¹/₈"

LESC Ewall Concrete Spigolo
0,8x20 - 3¹/₈"x7¹/₈"

AESC Spigolo A.E.
0,8x0,8 - 3¹/₈"x3¹/₈"

LESE Ewall Petroleum Green Spigolo
0,8x20 - 3¹/₈"x7¹/₈"

AESE Spigolo A.E.
0,8x0,8 - 3¹/₈"x3¹/₈"

LESN Ewall Night Spigolo
0,8x20 - 3¹/₈"x7¹/₈"

AESN Spigolo A.E.
0,8x0,8 - 3¹/₈"x3¹/₈"



**V2
SLIGHT
VARIATION**

Pure,
Concrete,
Night,
Amethyst,
Petroleum Green



8E4Z Ewall White 40X80
40x80 - 15³/₄"x31¹/₂"



8E4V Ewall Suede 40X80
40x80 - 15³/₄"x31¹/₂"



8E4K Ewall Moka 40X80
40x80 - 15³/₄"x31¹/₂"



8E4G Ewall Orange 40X80
40x80 - 15³/₄"x31¹/₂"



8E4Q Ewall Red 40X80
40x80 - 15³/₄"x31¹/₂"

TRIM TILES / PEZZI SPECIALI

LESW Ewall White Spigolo
0,8x20 - 3¹/₈"x7¹/₈"

AESW Spigolo A.E.
0,8x0,8 - 3¹/₈"x3¹/₈"

LESO Ewall Orange Spigolo
0,8x20 - 3¹/₈"x7¹/₈"

AESO Spigolo A.E.
0,8x0,8 - 3¹/₈"x3¹/₈"

LESS Ewall Suede Spigolo
0,8x20 - 3¹/₈"x7¹/₈"

AESD Spigolo A.E.
0,8x0,8 - 3¹/₈"x3¹/₈"

LESR Ewall Red Spigolo
0,8x20 - 3¹/₈"x7¹/₈"

AESR Spigolo A.E.
0,8x0,8 - 3¹/₈"x3¹/₈"

LESM Ewall Moka Spigolo
0,8x20 - 3¹/₈"x7¹/₈"

AESM Spigolo A.E.
0,8x0,8 - 3¹/₈"x3¹/₈"



**V2
SLIGHT
VARIATION**

White,
Suede,
Moka,
Orange,
Red

MATTE SURFACE | SUPERFICIE MATT | Surface Mat | Matt oberfläche | Superficie Mate | Матовая поверхность

Ewall Wall Tiles / Rivestimento

DECOR RANGE / GAMMA DECORI



9EMI Ewall Pure MiniBrick ✓
30,5x30,5 - 12"x12"



9EMC Ewall Concrete MiniBrick ✓
30,5x30,5 - 12"x12"



9EMN Ewall Night MiniBrick ✓
30,5x30,5 - 12"x12"



9EMP Ewall Platinum Mosaic ✓ ✓
30,5x30,5 - 12"x12"

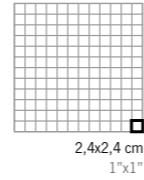

2,4x2,4 cm
1"x1"



9EMW Ewall White MiniBrick ✓
30,5x30,5 - 12"x12"



9EMS Ewall Suede MiniBrick ✓
30,5x30,5 - 12"x12"



9EMM Ewall Moka MiniBrick ✓
30,5x30,5 - 12"x12"



• **DECOR WITH PLATINUM INSERT.**
DECORO CON INSERTO IN PLATINO.
Décor avec insert en PLATINE.
Dekor mit Einlage PLATIN.
Decoración con aplicación de PLATINO.
Декор с ПЛАТИНОВОЙ вставкой

✓ **MATCHING WITH BOTH SIZES 40X80 AND 30.5X56.**
ABBINABILI A ENTRAMBI I FORMATI 40X80 E 30,5X56.
Combinables avec les deux formats 40x80 et 30,5x56.
Kombinierbar mit den beiden Formaten 40x80 und 30,5x56.
Combinables con ambos formatos 40x80 y 30,5x56.
Сочетается с обоими форматами: 40x80 и 30,5x56.



9EMO Ewall Orange MiniBrick ✓
30,5x30,5 - 12"x12"



9EMR Ewall Red MiniBrick ✓
30,5x30,5 - 12"x12"



9EMA Ewall Amethyst MiniBrick ✓
30,5x30,5 - 12"x12"



9EME Ewall Petroleum Green MiniBrick ✓
30,5x30,5 - 12"x12"

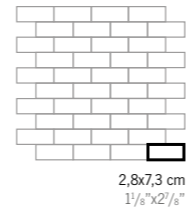

2,8x7,3 cm
1 1/8"x2 7/8"



8EDW Ewall White Gold Damask •
40x80 - 15 3/4"x31 1/2"



8EDH Ewall Petroleum Green Damask
40x80 - 15 3/4"x31 1/2"



8EDK Ewall Moka Gold Damask •
40x80 - 15 3/4"x31 1/2"



8ERW Ewall White Roses
40x80 - 15 3/4"x31 1/2"



8E4U Ewall Pure Stripes
40x80 - 15 3/4"x31 1/2"



8E4Y Ewall White Stripes
40x80 - 15 3/4"x31 1/2"



8EEO Ewall Orange Stripes
40x80 - 15 3/4"x31 1/2"



8EEA Ewall Amethyst Stripes
40x80 - 15 3/4"x31 1/2"



8EER Ewall Red Stripes
40x80 - 15 3/4"x31 1/2"



8EEP Ewall Petroleum Green Stripes
40x80 - 15 3/4"x31 1/2"



8EEM Ewall Moka Gold Stripes •
40x80 - 15 3/4"x31 1/2"

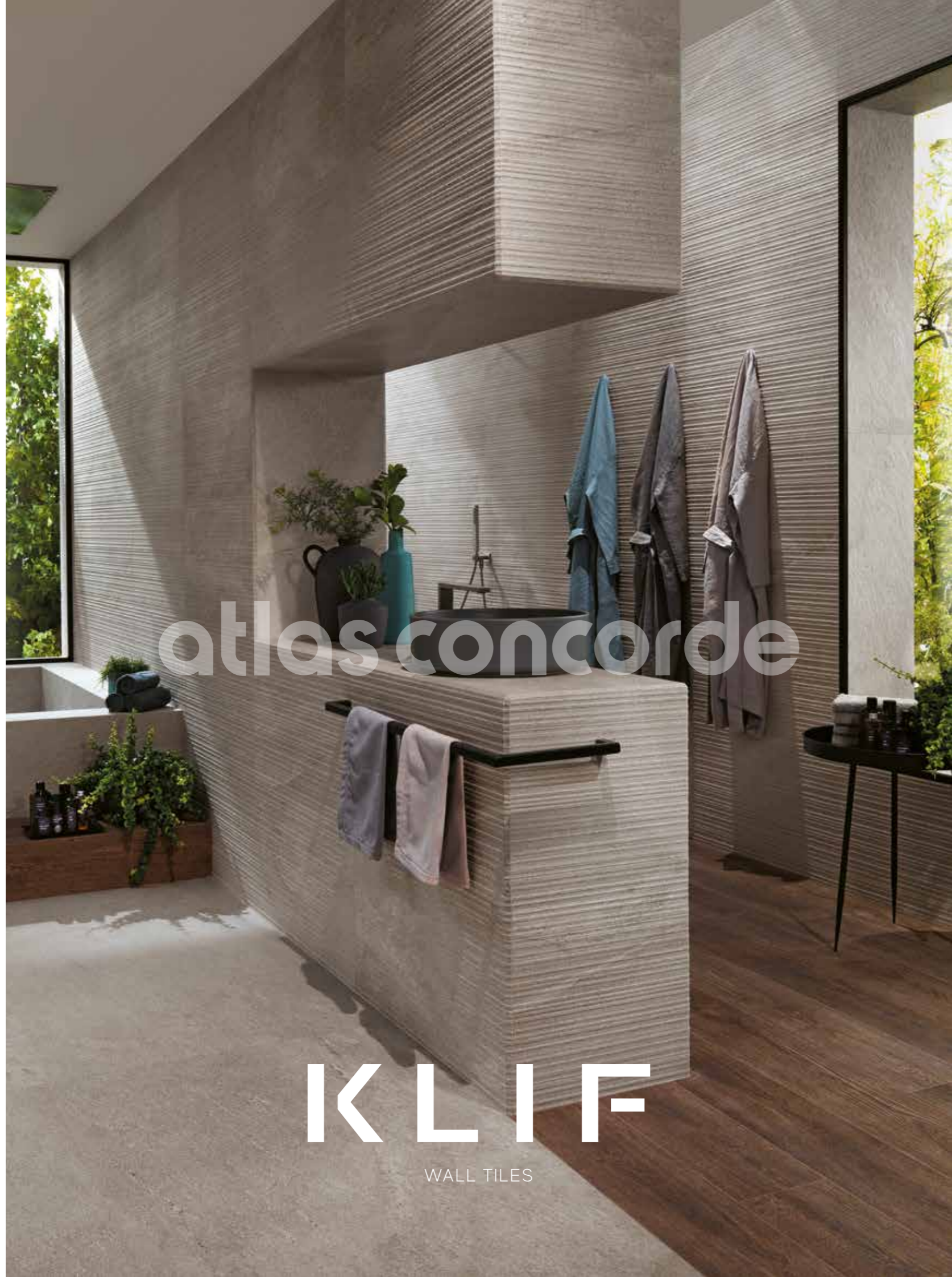

atlas concorde

KLIF
WALL TILES



Wall Tiles / Rivestimento

WHITEBODY WALL TILES - RECTIFIED MONOCALIBER
RIVESTIMENTI IN PASTA BIANCA - RETTIFICATO MONOCALIBRO

COORDINATED PORCELAIN TILES p. 260

Sizes	Thickness	Surface finish
40x80 cm - 15 ³ / ₄ "x31 ¹ / ₂ "	± 8,5 mm	Matte

3D Wall Tiles

Sizes	Thickness	Surface finish
40x80 cm - 15 ³ / ₄ "x31 ¹ / ₂ "	± 10 mm	Matte



atlas concorde

WHITEBODY WALL TILES | RIVESTIMENTI IN PASTA BIANCA | Revêtements en pâte blanche | Weißscherbige Wandfliesen | Revestimientos en pasta blanca | Настенная плитка из белой глины
RECTIFIED MONOCALIBER | RETTIFICATO MONOCALIBRO | Rectifié mono-calibre | Geschliffen einkalbrig | Rectificado monocalibre | Ретицированный в одном калибре

Klif Wall Tiles / Rivestimento

MATTE SURFACE / SUPERFICIE MATT



8K8W Klif White 40x80
40x80 - 15³/₄"x31¹/₂"



8K8S Klif Silver 40x80
40x80 - 15³/₄"x31¹/₂"

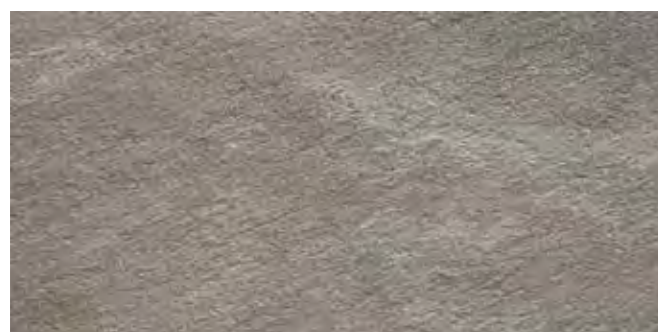

8K8G Klif Grey 40x80
40x80 - 15³/₄"x31¹/₂"



TRIM TILES / PEZZI SPECIALI

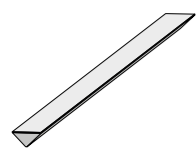

1,4x40 cm - 5⁵/₈"x15³/₄"
LK4W Klif White Corner 40 •
LK4S Klif Silver Corner 40 •
LK4G Klif Grey Corner 40 •



1,4x1,4 cm - 5⁵/₈"x5⁵/₈"
AKCW Klif White Corner A.E. •
AKCL Klif Silver Corner A.E. •
AKCG Klif Grey Corner A.E. •



V2
SLIGHT
VARIATION

* THESE PARTS ARE SUPPLIED TO ORDER . I PEZZI SONO DISPONIBILI SU ORDINAZIONE
Les pièces sont disponibles sur commande | Die Teile sind auf Bestellung lieferbar | Las piezas se hacen por encargo | Изготавливаются на заказ
MATTE SURFACE | SUPERFICIE MATT | Surface Mat | Matt oberfläche | Superficie Mate | Матовая поверхность

Klif 3D Wall Tiles / Rivestimento 3D

MATTE SURFACE / SUPERFICIE MATT



8KRW Klif 3D Row White 40x80
40x80 - 15³/₄"x31¹/₂"



8KRS Klif 3D Row Silver 40x80
40x80 - 15³/₄"x31¹/₂"



8KRG Klif 3D Row Grey 40x80
40x80 - 15³/₄"x31¹/₂"



TRIM TILES / PEZZI SPECIALI

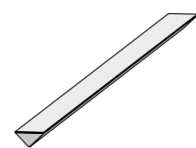

1,4x40 cm - 5⁵/₈"x15³/₄"
LY3W Klif White 3D Corner 40 •
LY3S Klif Silver 3D Corner 40 •
LY3G Klif Grey 3D Corner 40 •



1,4x1,4 cm - 5⁵/₈"x5⁵/₈"
AK3W Klif White Corner A.E. •
AK3S Klif Silver Corner A.E. •
AK3G Klif Grey Corner A.E. •



V2
SLIGHT
VARIATION

* THESE PARTS ARE SUPPLIED TO ORDER . I PEZZI SONO DISPONIBILI SU ORDINAZIONE
Les pièces sont disponibles sur commande | Die Teile sind auf Bestellung lieferbar | Las piezas se hacen por encargo | Изготавливаются на заказ
MATTE SURFACE | SUPERFICIE MATT | Surface Mat | Matt oberfläche | Superficie Mate | Матовая поверхность



atlas concorde

KONE

WALL TILES



Wall Tiles / Rivestimento

WHITEBODY WALL TILES - RECTIFIED MONOCALIBER
RIVESTIMENTI IN PASTA BIANCA - RETTIFICATO MONOCALIBRO

COORDINATED PORCELAIN TILES p. 268

Sizes	Thickness	Surface finish
50x110 cm - 19 ⁵ / ₈ "x43 ¹ / ₄ "	± 8,5 mm	Matte
40x80 cm - 15 ³ / ₄ "x31 ¹ / ₂ "	± 8,5 mm	Matte

3D Wall Tiles

Sizes	Thickness	Surface finish
50x110 cm - 19 ⁵ / ₈ "x43 ¹ / ₄ "	± 11 mm	Matte
40x80 cm - 15 ³ / ₄ "x31 ¹ / ₂ "	± 10 mm	Matte

DECORATIVE RANGE / GAMMA DECORATIVA



MOSAIC



atlas concorde

Kone Wall Tiles / Rivestimento

MATTE SURFACE / SUPERFICIE MATT



4K1W Kone White 50x110
50x110 cm - 19³/₈"x43³/₄"



8K4W Kone White 40x80
40x80 cm - 15³/₄"x31¹/₂"



4K1S Kone Silver 50x110
50x110 cm - 19³/₈"x43³/₄"



8K4S Kone Silver 40x80
40x80 cm - 15³/₄"x31¹/₂"



4K1B Kone Beige 50x110
50x110 cm - 19³/₈"x43³/₄"



8K4B Kone Beige 40x80
40x80 cm - 15³/₄"x31¹/₂"

TRIM TILES / PEZZI SPECIALI

LKSW Kone White Spigolo
0,8x20 cm - ³/₈"x7⁷/₈"

LKSS Kone Silver Spigolo
0,8x20 cm - ³/₈"x7⁷/₈"

LKSE Kone Beige Spigolo
0,8x20 cm - ³/₈"x7⁷/₈"

AKSW Kone White Spigolo A.E.
0,8x0,8 cm - ³/₈"x³/₈"

AKSS Kone Silver Spigolo A.E.
0,8x0,8 cm - ³/₈"x³/₈"

AKSB Kone Beige Spigolo A.E.
0,8x0,8 cm - ³/₈"x³/₈"



V2
SLIGHT
VARIATION
White,
Silver,
Beige

Kone 3D Wall Tiles / Rivestimento 3D

MATTE SURFACE / SUPERFICIE MATT



4K3W Kone 3D Line White 50x110
50x110 cm - 19³/₈"x43³/₄"



8K3W Kone 3D Stars White 40x80
40x80 cm - 15³/₄"x31¹/₂"



4K3S Kone 3D Line Silver 50x110
50x110 cm - 19³/₈"x43³/₄"



8K3S Kone 3D Stars Silver 40x80
40x80 cm - 15³/₄"x31¹/₂"

TRIM TILES / PEZZI SPECIALI

LK1W Kone White Spigolo 10mm *
1x20 cm - ³/₈"x7⁷/₈"

LK1S Kone Silver Spigolo 10mm *
1x20 cm - ³/₈"x7⁷/₈"

DECOR RANGE / GAMMA DECORI



9KMW Kone White Mosaic
30,5x30,5 - 12"x12"



9KMB Kone Beige Mosaic
30,5x30,5 - 12"x12"



9KMS Kone Silver Mosaic
30,5x30,5 - 12"x12"

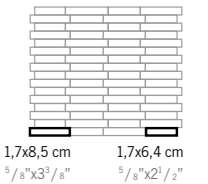

* THESE PARTS ARE SUPPLIED TO ORDER . I PEZZI SONO DISPONIBILI SU ORDINAZIONE
Les pièces sont disponibles sur commande | Die Teile sind auf Bestellung lieferbar | Las piezas se hacen por encargo | Изготавливаются на заказ

The 10 mm edge matches three-dimensional wall tiles having a 10-11 mm thickness / Lo spigolo 10 mm si abbina a rivestimenti tridimensionali di spessore 10-11 mm / Le bord 10 mm s'adapte aux revêtements tridimensionnels épaisseur 10-11 mm / Die 10 mm Kante ist mit dreidimensionalen Wandfliesen mit einer Dicke von 10-11 mm kombinierbar / La arista de 10 mm se combina con revestimientos tridimensionales de 10-11 mm de grosor / Угловой элемент 10 мм сочетается с трехмерной настенной плиткой толщиной 10-11 мм

MATTE SURFACE | SUPERFICIE MATT | Surface Mat | Matt Oberfläche | Superficie Mate | Матовая поверхность



V2
SLIGHT
VARIATION
3D Line White,
3D Line Silver,
3D Stars White,
3D Stars Silver



MARVEL

WALL TILES

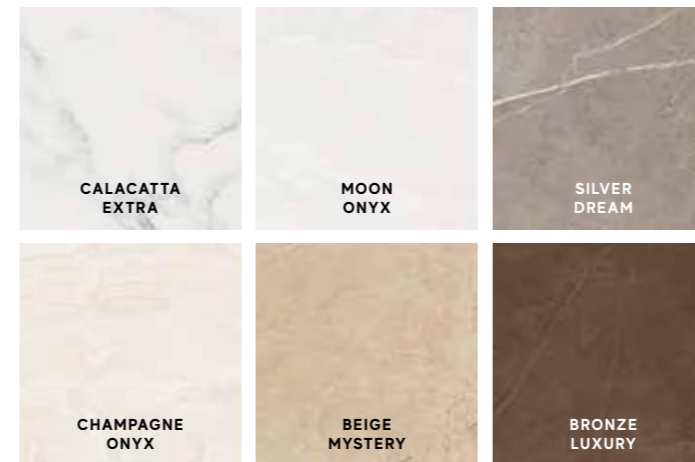

Wall Tiles / Rivestimento

WHITEBODY WALL TILES - RECTIFIED MONOCALIBER
RIVESTIMENTI IN PASTA BIANCA - RETTIFICATO MONOCALIBRO

COORDINATED PORCELAIN TILES p. 174

Sizes	Thickness	Surface finish
50x110 cm - 19 ⁵ / ₈ "x43 ¹ / ₄ "	± 8,5 mm	Shiny
40x80 cm - 15 ³ / ₄ "x31 ¹ / ₂ "	± 8,5 mm	Shiny
30,5x91,5 cm - 12"x36"	± 8,5 mm	Shiny
30,5x56 cm - 12"x22"	± 8,5 mm	Shiny
8x31,5 cm - 3 ¹ / ₈ "x12 ³ / ₈ "	± 8,5 mm	Shiny

DECORATIVE RANGE / GAMMA DECORATIVA

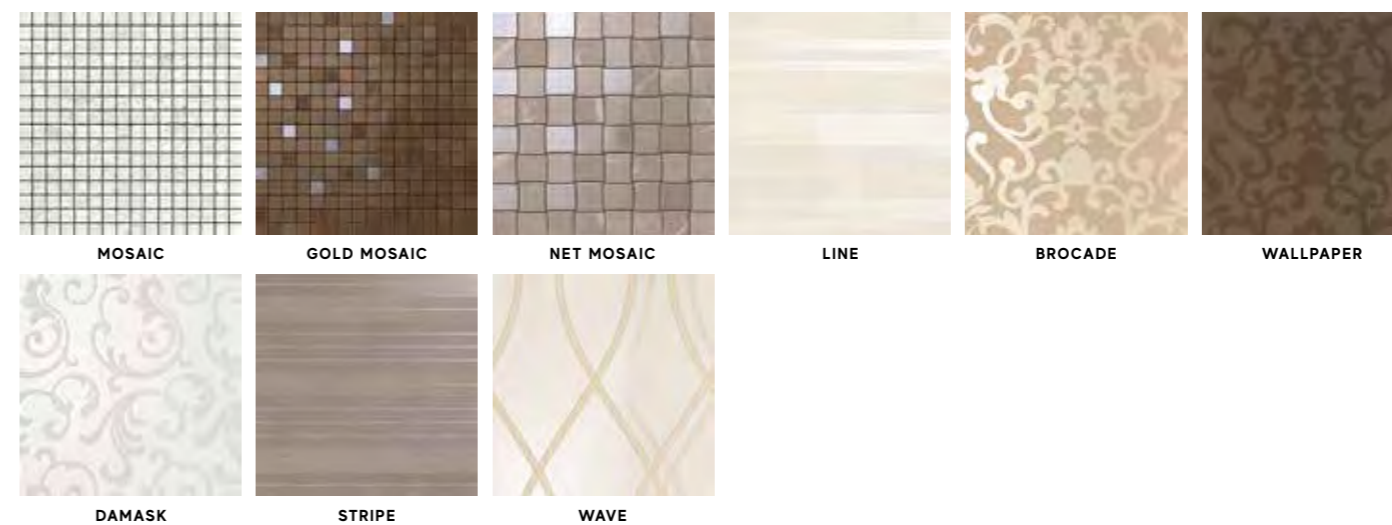

Marvel Wall Tiles / Rivestimento

SHINY SURFACE / SUPERFICIE LUCIDA



4MPC Marvel Calacatta Extra 50x110
50x110 - 19⁵/₈"x43³/₄"



LMKC Marvel Calacatta Extra Brick
8x31,5 - 3¹/₈"x12³/₈"

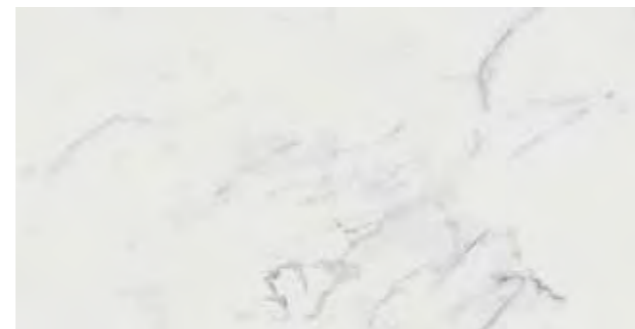

8MVA Marvel Calacatta Extra 40x80
40x80 - 15³/₄"x31¹/₂"



4MPV Marvel Silver Dream 50x110
50x110 - 19⁵/₈"x43³/₄"



LMKS Marvel Silver Dream Brick
8x31,5 - 3¹/₈"x12³/₈"



8MVS Marvel Silver Dream 40x80
40x80 - 15³/₄"x31¹/₂"



4MPH Marvel Champagne Onyx 50x110
50x110 - 19⁵/₈"x43³/₄"



8MVC Marvel Champagne Onyx 40x80
40x80 - 15³/₄"x31¹/₂"



**V2
SLIGHT
VARIATION**
Calacatta Extra,
Silver Dream,
Champagne Onyx



**V2
SLIGHT
VARIATION**
Calacatta Extra,
Silver Dream,
Champagne Onyx

Marvel Wall Tiles / Rivestimento

SHINY SURFACE / SUPERFICIE LUCIDA



AR5J Marvel Calacatta Extra 30,5x91,5
30,5x91,5 - 12"x36"



AR5L Marvel Moon Onyx 30,5x91,5
30,5x91,5 - 12"x36"



AR5N Marvel Silver Dream 30,5x91,5
30,5x91,5 - 12"x36"



AR5K Marvel Champagne Onyx 30,5x91,5
30,5x91,5 - 12"x36"



AR5M Marvel Beige Mystery 30,5x91,5
30,5x91,5 - 12"x36"



AR5O Marvel Bronze Luxury 30,5x91,5
30,5x91,5 - 12"x36"

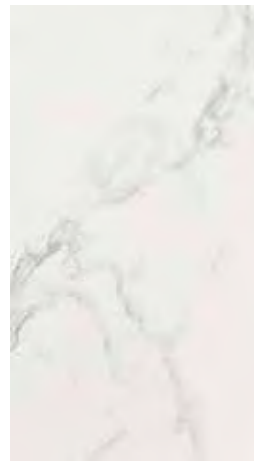

9P5L Marvel Calacatta Extra 30,5x56
30,5x56 - 12"x22"



9P5M Marvel Moon Onyx 30,5x56
30,5x56 - 12"x22"

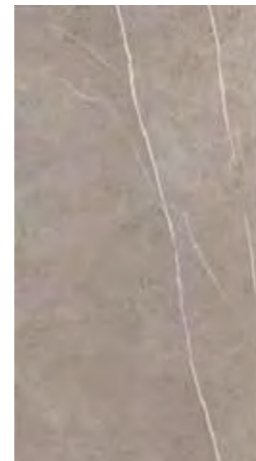

9P5S Marvel Silver Dream 30,5x56
30,5x56 - 12"x22"



9P5H Marvel Champagne Onyx 30,5x56
30,5x56 - 12"x22"



9P5E Marvel Beige Mystery 30,5x56
30,5x56 - 12"x22"



9P5O Marvel Bronze Luxury 30,5x56
30,5x56 - 12"x22"

TRIM TILES / PEZZI SPECIALI



ASDZ Marvel Calacatta London
5x30,5 - 2"x12"



ASD7 Marvel
London A.E.
5x2,5 - 2"x1"



ASD1 Marvel Moon London
5x30,5 - 2"x12"



ASD9 Marvel
London A.E.
5x2,5 - 2"x1"



ASD4 Marvel Silver London
5x30,5 - 2"x12"



ASEC Marvel
London A.E.
5x2,5 - 2"x1"

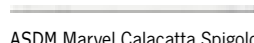

ASDM Marvel Calacatta Spigolo
0,85x30,5 - 3/8"x12"



ASEE Marvel
Spigolo A.E.
0,85x0,85 - 3/8"x3/8"

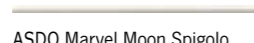

ASDO Marvel Moon Spigolo
0,85x30,5 - 3/8"x12"



ASEG Marvel
Spigolo A.E.
0,85x0,85 - 3/8"x3/8"

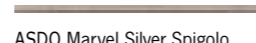

ASDQ Marvel Silver Spigolo
0,85x30,5 - 3/8"x12"

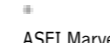

ASEI Marvel
Spigolo A.E.
0,85x0,85 - 3/8"x3/8"



ASDG Marvel Calacatta Alzata
20x30,5 - 7/8"x12"



ASDT Marvel
Alzata A.E.
1,5x20 - 5/8"x7 7/8"



ASDH Marvel Moon Alzata
20x30,5 - 7/8"x12"



ASDV Marvel
Alzata A.E.
1,5x20 - 5/8"x7 7/8"



ASDK Marvel Silver Alzata
20x30,5 - 7/8"x12"



ASDX Marvel
Alzata A.E.
1,5x20 - 5/8"x7 7/8"



**V2
SLIGHT
VARIATION**
Calacatta Extra,
Moon Onyx,
Silver Dream

TRIM TILES / PEZZI SPECIALI



ASDØ Marvel Champagne London
5x30,5 - 2"x12"



ASD8 Marvel
London A.E.
5x2,5 - 2"x1"



ASD3 Marvel Beige London
5x30,5 - 2"x12"



ASEA Marvel
London A.E.
5x2,5 - 2"x1"



ASD5 Marvel Bronze London
5x30,5 - 2"x12"



ASED Marvel
London A.E.
5x2,5 - 2"x1"



ASDN Marvel Champagne Spigolo
0,85x30,5 - 3/8"x12"



ASEF Marvel
Spigolo A.E.
0,85x0,85 - 3/8"x3/8"



ASDP Marvel Beige Spigolo
0,85x30,5 - 3/8"x12"



ASEH Marvel
Spigolo A.E.
0,85x0,85 - 3/8"x3/8"

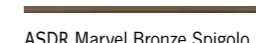

ASDR Marvel Bronze Spigolo
0,85x30,5 - 3/8"x12"



ASEJ Marvel
Spigolo A.E.
0,85x0,85 - 3/8"x3/8"



ASDF Marvel Champagne Alzata
20x30,5 - 7/8"x12"



ASDU Marvel
Alzata A.E.
1,5x20 - 5/8"x7 7/8"



ASDJ Marvel Beige Alzata
20x30,5 - 7/8"x12"



ASDW Marvel
Alzata A.E.
1,5x20 - 5/8"x7 7/8"



ASDL Marvel Bronze Alzata
20x30,5 - 7/8"x12"



ASDY Marvel
Alzata A.E.
1,5x20 - 5/8"x7 7/8"



**V2
SLIGHT
VARIATION**
Champagne Onyx,
Beige Mystery,
Bronze Luxury

Marvel Wall Tiles / Rivestimento

DECOR RANGE / GAMMA DECORI

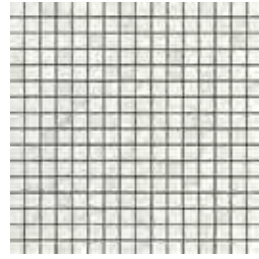

ASCM Marvel Calacatta Mosaic ✓
30,5x30,5 - 12"x12"

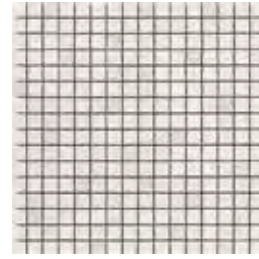

ASCO Marvel Moon Mosaic ✓
30,5x30,5 - 12"x12"

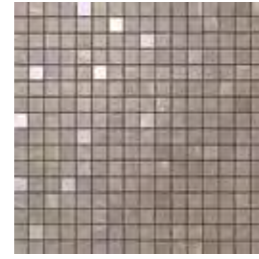

ASCR Marvel Silver Mosaic ✓
30,5x30,5 - 12"x12"



ASCT Marvel Bronze Gold Mosaic ✓ •
30,5x30,5 - 12"x12"

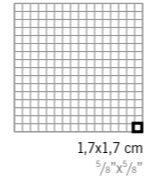

• **DECOR WITH GOLD INSERT.**
DECORO CON INSERTO IN ORO.
Décor avec insert en OR.
Dekor mit Einlage GOLD.
Decoración con aplicación de ORO.
Декор с ЗОЛОТОЙ вставкой.

✓ **MATCHING WITH BOTH SIZES 30.5X91.5 AND 30.5X56.**
ABBINABILI A ENTRAMBI I FORMATI 30,5x91,5 E 30,5x56.
Combinables avec les deux formats 30,5x91,5 et 30,5x56.
Kombinierbar mit den beiden Formaten 30,5x91,5 und 30,5x56.
Combinables con ambos formatos 30,5x91,5 y 30,5x56.
Сочетается с обоими форматами: 30,5x91,5 и 30,5x56.

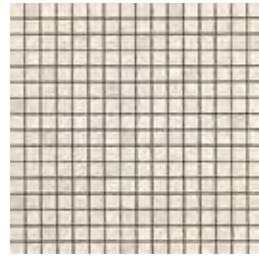

ASCN Marvel Champagne Mosaic ✓
30,5x30,5 - 12"x12"



ASCQ Marvel Beige Mosaic ✓
30,5x30,5 - 12"x12"

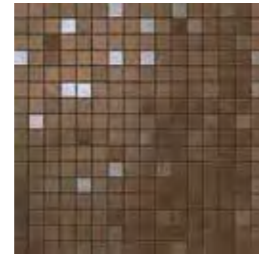

ASCS Marvel Bronze Mosaic ✓
30,5x30,5 - 12"x12"



ASCV Marvel Silver Net Mosaic ✓
30,5x30,5 - 12"x12"



ASCX Marvel Beige Net Mosaic ✓
30,5x30,5 - 12"x12"



ASCW Marvel Bronze Net Mosaic ✓
30,5x30,5 - 12"x12"

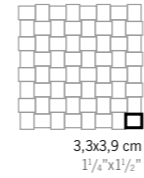

• **ALSO MATCHING WITH CALACATTA EXTRA.**
ABBINABILE ANCHE AL CALACATTA EXTRA.
Combinable également avec Calacatta Extra.
Kombinierbar auch mit Calacatta Extra.
Combinable también con Calacatta Extra.
Сочетается также с Calacatta Extra.

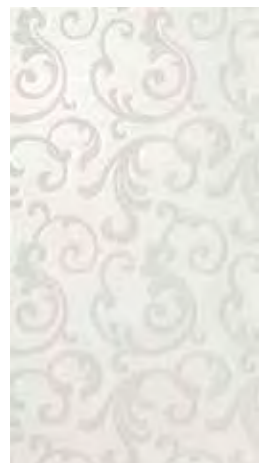

ASC1 Marvel Moon Damask •
30,5x56 - 12"x22"

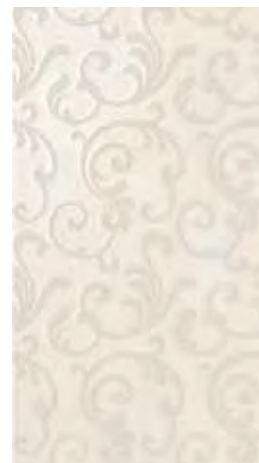

ASCØ Marvel Champagne Damask
30,5x56 - 12"x22"



ASC4 Marvel Silver Stripe
30,5x56 - 12"x22"

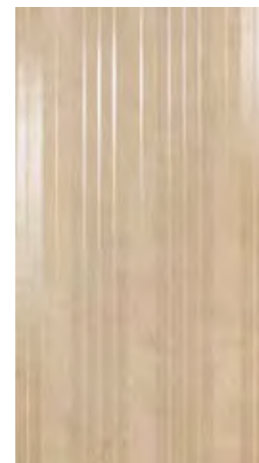

ASC3 Marvel Beige Stripe
30,5x56 - 12"x22"



ASCC Marvel Moon Line
30,5x91,5 - 12"x36"



ASCA Marvel Champagne Line
30,5x91,5 - 12"x36"



ASEN Marvel Champagne Wave
30,5x91,5 - 12"x36"



ASCZ Marvel Beige Brocade
30,5x91,5 - 12"x36"



ASCY Marvel Bronze Brocade
30,5x91,5 - 12"x36"

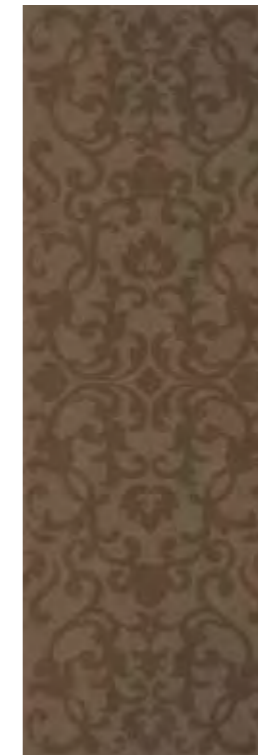

ASCD Marvel Bronze Wallpaper
30,5x91,5 - 12"x36"



ASDC Marvel Calacatta Terminale Lesena
10x20 - 3 7/8"x7 7/8"



ASC9 Marvel Champagne Terminale Lesena
10x20 - 3 7/8"x7 7/8"



ASC6 Marvel Calacatta Lesena
30,5x20 - 12"x7 7/8"



ASC5 Marvel Champagne Lesena
30,5x20 - 12"x7 7/8"



ASC8 Marvel Calacatta Base Lesena
20x20 - 7 7/8"x7 7/8"



ASC7 Marvel Champagne Base Lesena
20x20 - 7 7/8"x7 7/8"



ASDE Marvel Calacatta Fregio
10x30,5 - 3 7/8" x12"



ASDD Marvel Champagne Fregio
10x30,5 - 3 7/8" x12"



ASEK Marvel Greca Gold •
7,8x30,5 - 3 1/8" x12"

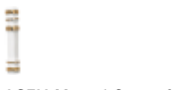

ASEM Marvel Greca A.E. •
7,8x1,2 - 3 1/8" x1 1/2"

• **Decor with GOLD insert.**
Decoro con inserto in ORO.
Décor avec insert en OR.
Dekor mit Einlage GOLD.
Decoración con aplicación de ORO.
Декор с ЗОЛОТОЙ вставкой.



MARVEL

DREAM

WALL TILES

Wall Tiles / Rivestimento

WHITEBODY WALL TILES - RECTIFIED MONOCALIBER
RIVESTIMENTI IN PASTA BIANCA - RETTIFICATO MONOCALIBRO

COORDINATED PORCELAIN TILES p. 186

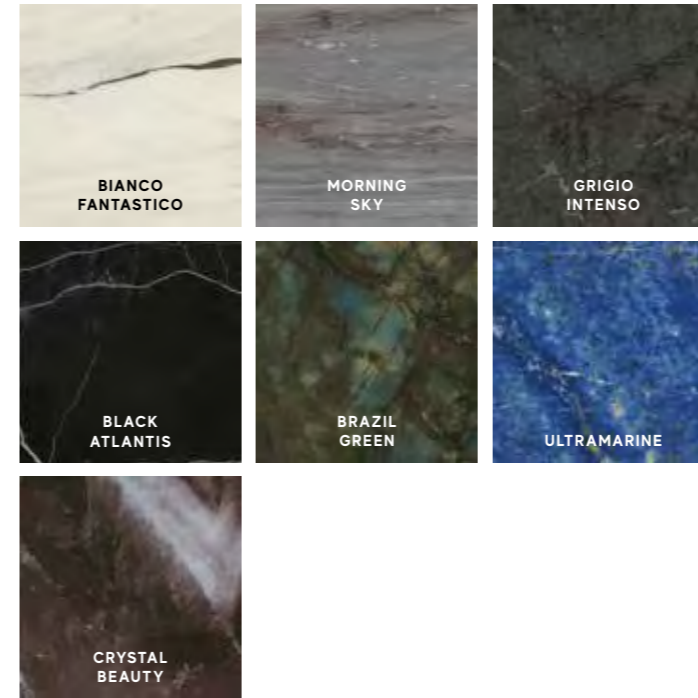

Sizes	Thickness	Surface finish
50x110 cm - 19 ⁵ / ₈ "x43 ¹ / ₄ "	± 8,5 mm	Shiny

DECORATIVE RANGE / GAMMA DECORATIVA

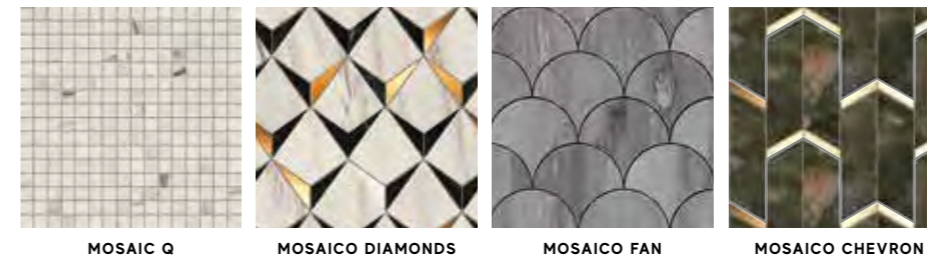

WHITEBODY WALL TILES | RIVESTIMENTI IN PASTA BIANCA | Revêtements en pâte blanche | Weißscherbige Wandfliesen | Revestimientos en pasta blanca | Настенная плитка из белой глины
RECTIFIED MONOCALIBER | RETTIFICATO MONOCALIBRO | Rectifié mono-calibre | Geschliffen einkalibrig | Rectificado monocalibre | Ретицированный в одном калибре

Marvel Dream Wall Tiles / Rivestimento

SHINY SURFACE / SUPERFICIE LUCIDA



4MDB Marvel Bianco Fantastico 50x110
50x110 cm - 19⁵/₈"x43³/₄"



4MDS Marvel Morning Sky 50x110
50x110 cm - 19⁵/₈"x43³/₄"

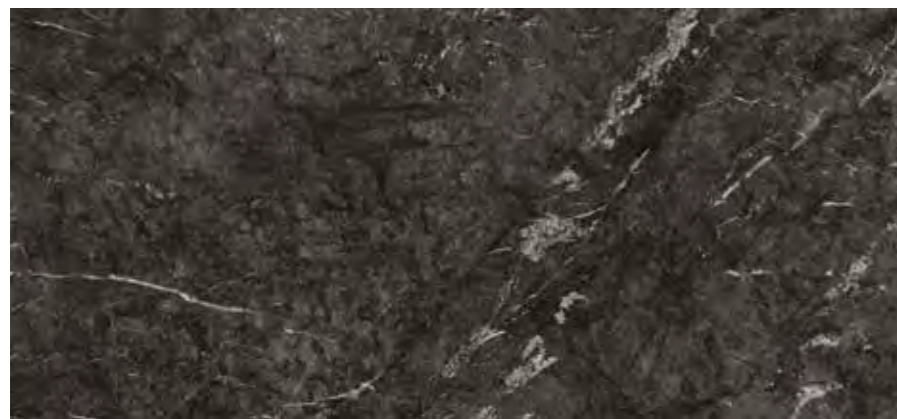

4MDI Marvel Grigio Intenso 50x110
50x110 cm - 19⁵/₈"x43³/₄"

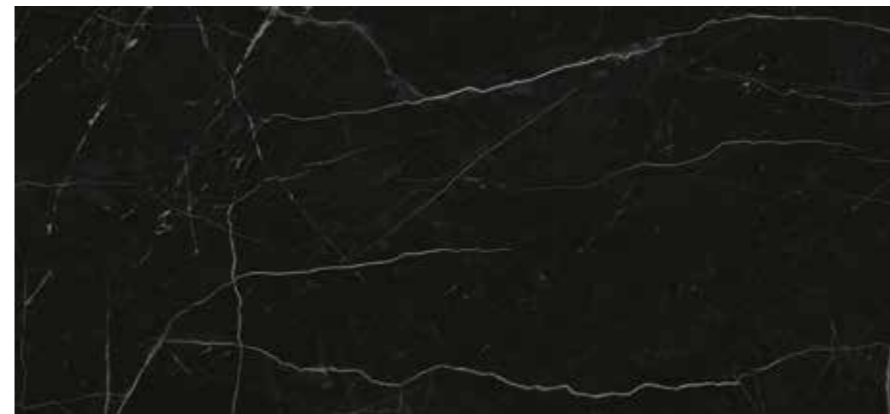

4MDN Marvel Black Atlantis 50x110
50x110 cm - 19⁵/₈"x43³/₄"

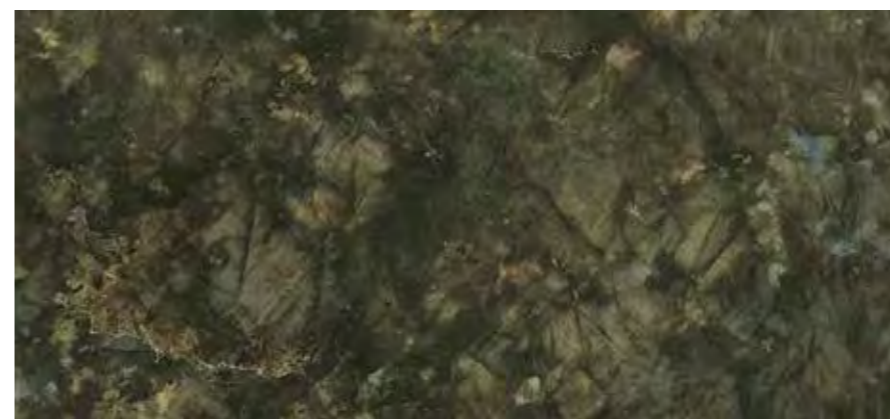

4DMG Marvel Brazil Green 50x110
50x110 cm - 19⁵/₈"x43³/₄"



4MDT Marvel Crystal Beauty 50x110
50x110 cm - 19⁵/₈"x43³/₄"

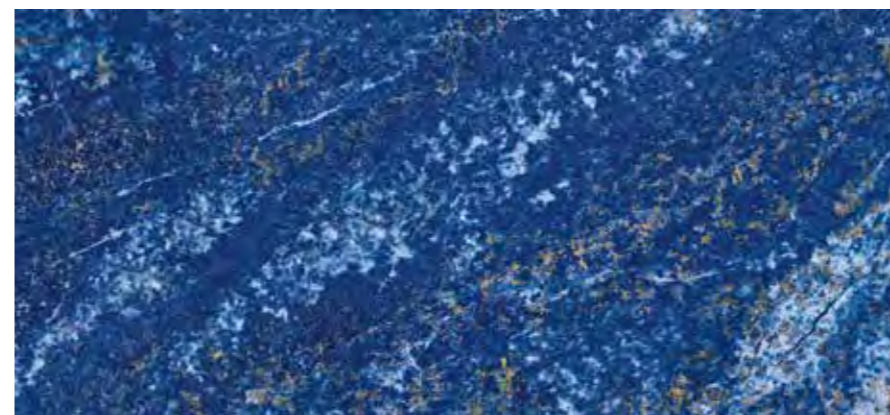

4MDM Marvel Ultramarine 50x110
50x110 cm - 19⁵/₈"x43³/₄"



**V2
SLIGHT
VARIATION**
Bianco Fantastico,
Grigio Intenso



**V3
MODERATE
VARIATION**
Morning Sky



**V2
SLIGHT
VARIATION**
Black Atlantis



**V3
MODERATE
VARIATION**
Brazil Green,
Ultramarine,
Crystal Beauty

Marvel Dream Wall Tiles / Rivestimento

DECOR RANGE / GAMMA DECORI

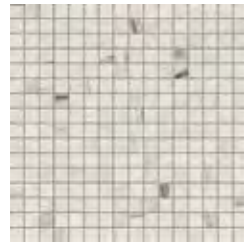

9MQI Marvel Bianco Fantastico Mosaic Q
30,5x30,5 - 12"x12"

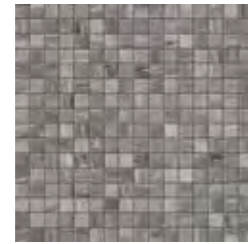

9MQS Marvel Morning Sky Mosaic Q
30,5x30,5 - 12"x12"

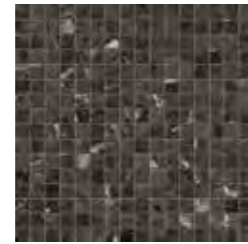

9MQG Marvel Grigio Intenso Mosaic Q
30,5x30,5 - 12"x12"

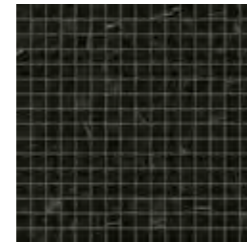

9MQK Marvel Black Atlantis Mosaic Q
30,5x30,5 - 12"x12"

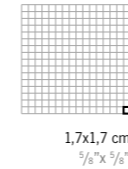

9MQH Marvel Brazil Green Mosaic Q
30,5x30,5 - 12"x12"



9MQT Marvel Crystal Beauty Mosaic Q
30,5x30,5 - 12"x12"

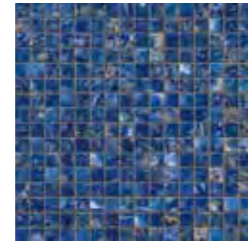

9MQD Marvel Ultramarine Mosaic Q
30,5x30,5 - 12"x12"



9MDB Marvel Diamonds Bianco - Black
35,8x32,9 - 14 1/8"x13"



9MDN Marvel Diamonds Bianco - Ultramarine
35,8x32,9 - 14 1/8"x13"

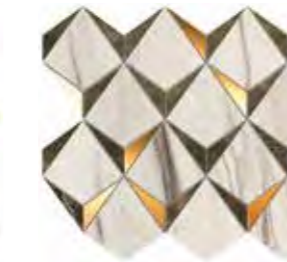

9MDG Marvel Diamonds Bianco - Green
35,8x32,9 - 14 1/8"x13"

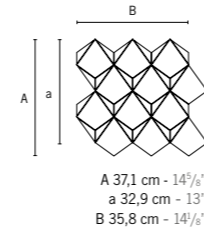

9MFB Marvel Fan Bianco Fantastico
29x29,2 - 11 3/8"x11 1/2"



9MFS Marvel Fan Morning Sky
29x29,2 - 11 3/8"x11 1/2"



9MFG Marvel Fan Grigio Intenso
29x29,2 - 11 3/8"x11 1/2"



9MFK Marvel Fan Black Atlantis
29x29,2 - 11 3/8"x11 1/2"

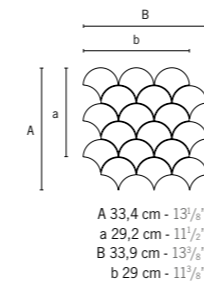

9MFE Marvel Fan Brazil Green
29x29,2 - 11 3/8"x11 1/2"



9MFL Marvel Fan Crystal Beauty
29x29,2 - 11 3/8"x11 1/2"



9MFM Marvel Fan Ultramarine
29x29,2 - 11 3/8"x11 1/2"



9MCN Marvel Chevron Bianco Fantastico
17x41,4 - 6 3/4"x16 1/8"



9MCO Marvel Chevron Brazil Green
17x41,4 - 6 3/4"x16 1/8"



9MCP Marvel Chevron Ultramarine
17x41,4 - 6 3/4"x16 1/8"

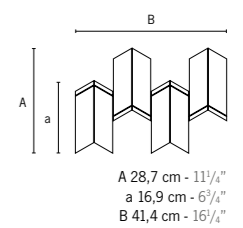

• For gold pieces, use an ordinary neutral cleaner. Avoid using acid or alkaline products, waxes and scour pads. / Parti in oro. Si consiglia l'utilizzo di un comune detergente neutro. Evitare l'utilizzo di prodotti acidi o alcalini, ceranti e pagliette di metallo. / Détails en or. Nous vous conseillons d'utiliser un détergent commun neutre. Evitez d'utiliser tout produit acide ou alcalin, cirants et grattoirs. / Vergoldete Teile. Verwenden Sie ein normales, neutrales Reinigungsmittel. Saure oder alkalische Produkte, Wache und Metallschwämme sind zu vermeiden. / Partes de oro. Se aconseja utilizar un detergente neutro habitual. Hay que evitar el empleo de productos ácidos o alcalinos, ceras y estropeados de metal. / Золотые детали. Рекомендуется чистить обычным нейтральным моющим средством. Не рекомендуется использовать кислотные, щелочные, восковые средства, а также металлические мочалки.



One of the six sheets in the box contains a golden tile with the Atlas Concorde logo. / Uno dei sei fogli contenuti nella scatola contiene una tessera dorata con logo Atlas Concorde. / Une des six feuilles dans la boîte contient une tesselle dorée avec logo Atlas Concorde. / Eine der sechs Matten im Karton enthält ein goldfarbnes Mosaiksteinchen mit dem Atlas Concorde-Logo. / En la caja encontrarán 6 folios, uno de éstos contiene una tarjeta dorada con el logotipo Atlas Concorde. / Один из шести листов, помещенных в коробку, содержит золотую табличку с логотипом Atlas Concorde.

TRIM TILES / PEZZI SPECIALI

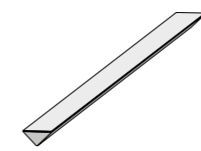

1,4x50 cm - 5/8"x19 5/8"
 LD5B Marvel Bianco Fantastico Corner 50 *
 LD5S Marvel Morning Sky Corner 50 *
 LD5G Marvel Grigio Intenso Corner 50 *
 LD5N Marvel Black Atlantis Corner 50 *
 LD5M Marvel Ultramarine Corner 50 *
 LD5E Marvel Brazil Green Corner 50 *
 LD5C Marvel Crystal Beauty Corner 50 *



1,4x1,4 cm - 5/8"x5/8"
 MD1B Marvel Bianco Fantastico Corner A.E. 1,4 *
 MD1S Marvel Morning Sky Corner A.E. 1,4 *
 MD1G Marvel Grigio Intenso Corner A.E. 1,4 *
 MD1N Marvel Black Atlantis Corner A.E. 1,4 *
 MD1M Marvel Ultramarine Corner A.E. 1,4 *
 MD1E Marvel Brazil Green Corner A.E. 1,4 *
 MD1C Marvel Crystal Beauty Corner A.E. 1,4 *

* THESE PARTS ARE SUPPLIED TO ORDER. I PEZZI SONO DISPONIBILI SU ORDINAZIONE
 Les pièces sont disponibles sur commande | Die Teile sind auf Bestellung lieferbar | Las piezas se hacen por encargo | Изготавливаются на заказ



atlas concorde

MARVEL

EDGE

WALL TILES

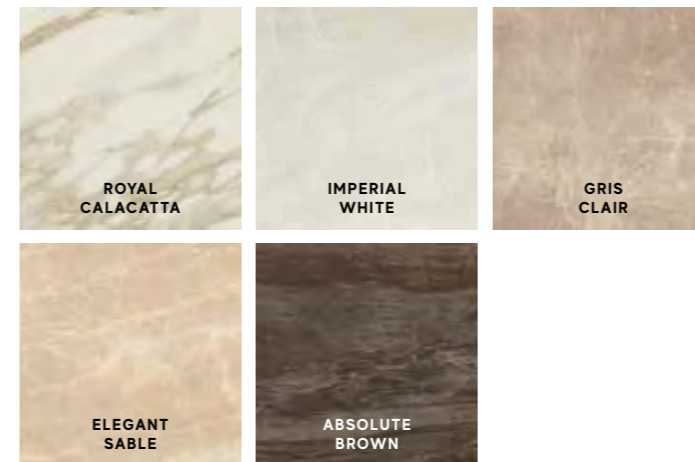

Wall Tiles / Rivestimento

WHITEBODY WALL TILES - RECTIFIED MONOCALIBER
RIVESTIMENTI IN PASTA BIANCA - RETTIFICATO MONOCALIBRO

COORDINATED PORCELAIN TILES p. 196

Sizes	Thickness	Surface finish
50x110 cm - 19 ⁵ / ₈ "x43 ¹ / ₄ "	± 8,5 mm	Shiny
40x80 cm - 15 ³ / ₄ "x31 ¹ / ₂ "	± 8,5 mm	Shiny

DECORATIVE RANGE / GAMMA DECORATIVA



atlas concorde

WHITEBODY WALL TILES | RIVESTIMENTI IN PASTA BIANCA | Revêtements en pâte blanche | Weißscherbige Wandfliesen | Revestimientos en pasta blanca | Настенная плитка из белой глины
RECTIFIED MONOCALIBER | RETTIFICATO MONOCALIBRO | Rectifié mono-calibre | Geschliffen einkalibrig | Rectificado monocalibril | Ретицированный в одном калибре

Marvel Edge Wall Tiles / Rivestimento

SHINY SURFACE / SUPERFICIE LUCIDA



4MEW Marvel Imperial White 50x110
50x110 cm - 19³/₈"x43³/₄"



4MER Marvel Royal Calacatta 50x110
50x110 cm - 19³/₈"x43³/₄"



4MES Marvel Elegant Sable 50x110
50x110 cm - 19³/₈"x43³/₄"



9MEW Marvel Imperial White 40x80
40x80 - 15³/₄"x31¹/₂"



9MER Marvel Royal Calacatta 40x80
40x80 - 15³/₄"x31¹/₂"



9MES Marvel Elegant Sable 40x80
40x80 - 15³/₄"x31¹/₂"



9EMG Marvel Gris Clair 40x80
40x80 - 15³/₄"x31¹/₂"

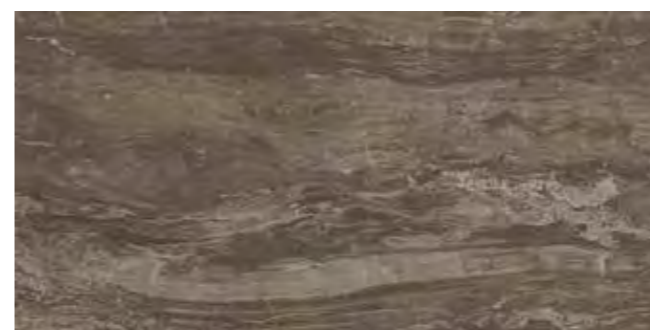

9MEB Marvel Absolute Brown 40x80
40x80 - 15³/₄"x31¹/₂"

TRIM TILES / PEZZI SPECIALI



V3
MODERATE
VARIATION
Royal Calacatta



V2
SLIGHT
VARIATION
Imperial White,
Elegant Sable

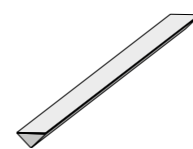

1,4x50 cm - 5⁵/₈"x19⁵/₈"
LM5C Marvel Royal Calacatta Corner 50 •
LM5W Marvel Imperial White Corner 50 •
LM5S Marvel Elegant Sable Corner 50 •

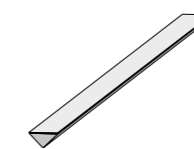

1,4x40 cm - 5⁵/₈"x15³/₄"
LM4C Marvel Royal Calacatta Corner 40 •
LM4W Marvel Imperial White Corner 40 •
LM4S Marvel Elegant Sable Corner 40 •
LM4G Marvel Gris Clair Corner 40 •
LM4O Marvel Absolute Brown Corner 40 •



1,4x1,4 cm - 5⁵/₈"x5⁵/₈"
AMCY Marvel Royal Calacatta Corner A.E. •
AMCX Marvel Imperial White Corner A.E. •
AMCS Marvel Elegant Sable Corner A.E. •
AMCR Marvel Gris Clair Corner A.E. •
AMCO Marvel Absolute Brown Corner A.E. •

* THESE PARTS ARE SUPPLIED TO ORDER . I PEZZI SONO DISPONIBILI SU ORDINAZIONE
Les pièces sont disponibles sur commande | Die Teile sind auf Bestellung lieferbar | Las piezas se hacen por encargo | Изготавливаются на заказ
SHINY SURFACE | SUPERFICIE LUCIDA | Surface brillante | Glänzende Oberfläche | Superficie brillante | Глянцевая поверхность



V3
MODERATE
VARIATION
Royal Calacatta,
Absolute Brown



V2
SLIGHT
VARIATION
Imperial White,
Elegant Sable,
Gris Clair

Marvel Edge Wall Tiles / Rivestimento

DECOR RANGE / GAMMA DECORI

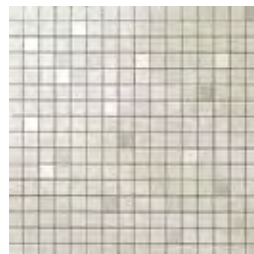

9EQW Marvel Imperial White Mosaic Q
30,5x30,5 - 12"x12"

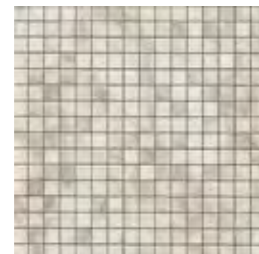

9EQC Marvel Royal Calacatta Mosaic Q
30,5x30,5 - 12"x12"

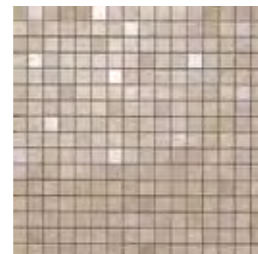

9EQG Marvel Gris Clair Mosaic Q
30,5x30,5 - 12"x12"

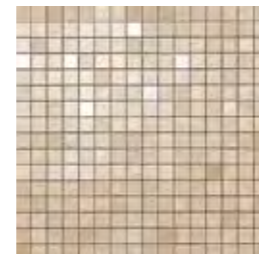

9EQS Marvel Elegant Sable Mosaic Q
30,5x30,5 - 12"x12"

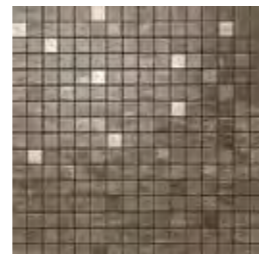

9EQB Marvel Absolute Brown Mosaic Q
30,5x30,5 - 12"x12"



9EDW Marvel Imperial White Drop Mosaic
27,2x29,7 - 10⁵/₈"x11⁵/₈"



9EDC Marvel Royal Calacatta Drop Mosaic
27,2x29,7 - 10⁵/₈"x11⁵/₈"



9EDR Marvel Gris Clair Drop Mosaic
27,2x29,7 - 10⁵/₈"x11⁵/₈"



9EDS Marvel Elegant Sable Drop Mosaic
27,2x29,7 - 10⁵/₈"x11⁵/₈"



9EDB Marvel Absolute Brown Drop Mosaic
27,2x29,7 - 10⁵/₈"x11⁵/₈"



9EHG Marvel Gold Hex Gris-Calacatta
25,1x29 - 9⁷/₈"x11³/₈"



9EHB Marvel Gold Hex Brown-Calacatta
25,1x29 - 9⁷/₈"x11³/₈"



9EHS Marvel Gold Hex Sable-Brown
25,1x29 - 9⁷/₈"x11³/₈"

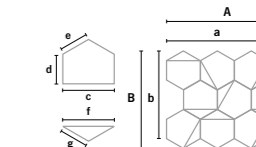

c 9,5 cm - 3³/₄"
d 5,4 cm - 2¹/₈"
e 5,5 cm - 2¹/₈"
f 9,2 cm - 3³/₈"
g 5,3 cm - 2¹/₈"
A 33,9 cm - 13³/₈"
a 29 cm - 11³/₈"
B 27,9 cm - 11"
b 25,1 cm - 9⁷/₈"

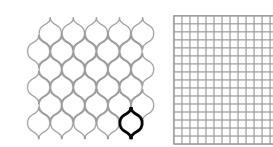

8x5,8 cm
3¹/₄"x2¹/₄"
1,7x1,7 cm
5³/₈"x5³/₈"

• **DECOR WITH GOLD INSERT.**
DECORO CON INSERTO IN ORO.
Décor avec insert en OR.
Dekor mit Einlage GOLD.
Decoración con aplicación de ORO.
Декор с ЗОЛОТОЙ вставкой.



Marvel Edge Wall Tiles / Rivestimento

DECOR RANGE / GAMMA DECORI



8EGD Marvel Royal Calacatta Gold Vein 1 ■■
40x80 - 15³/₄"x31¹/₂"



8EGE Marvel Royal Calacatta Gold Vein 2 ■■
40x80 - 15³/₄"x31¹/₂"



8EW1 Marvel Imperial White Gold Vein 1 ■■
40x80 - 15³/₄"x31¹/₂"



8EW2 Marvel Imperial White Gold Vein 2 ■■
40x80 - 15³/₄"x31¹/₂"



atlas concorde

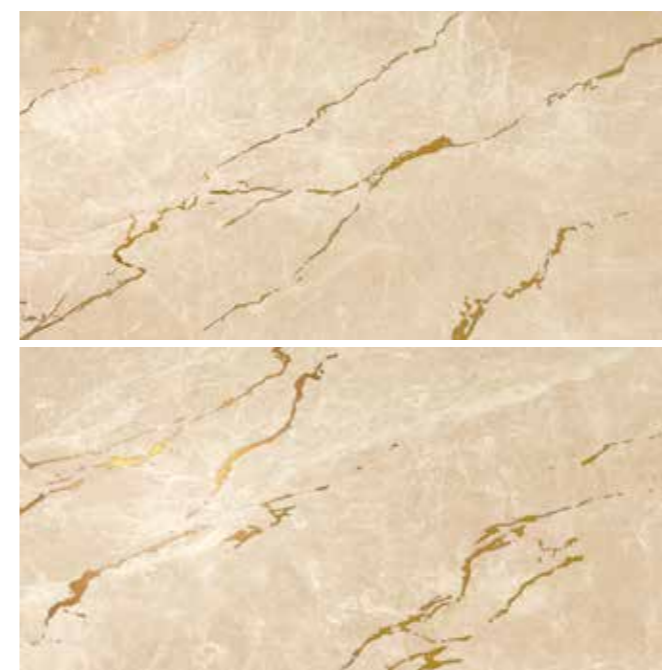

8ES1 Marvel Elegant Sable Gold Vein 1 ■■
40x80 - 15³/₄"x31¹/₂"



8ES2 Marvel Elegant Sable Gold Vein 2 ■■
40x80 - 15³/₄"x31¹/₂"

• **DECOR WITH GOLD INSERT.**
DECORO CON INSERTO IN ORO.
Décor avec insert en OR.
Dekor mit Einlage GOLD.
Decoración con aplicación de ORO.
Декор с ЗОЛОТОЙ вставкой.

■ **THE GOLD VEIN DECORATION CONSISTS OF FOUR DIFFERENT PATTERNS OF GOLDEN VEINS CONTAINED IN TWO BOXES OF TWO PIECES EACH: GOLD VEIN 1 AND GOLD VEIN 2.**
IL DECORO GOLD VEIN È COMPOSTO DA QUATTRO DIVERSI PATTERN DI VENE DORATE, CONTENUTI IN DUE SCATOLE DA 2 PEZZI CIASCUNA: GOLD VEIN 1 E GOLD VEIN 2.
Les décors Gold Vein sont composés de quatre différents motifs de veinures dorées et sont contenus dans deux boîtes de 2 pièces chacune : Gold Vein 1 et Gold Vein 2.
Das Dekor Gold Vein setzt sich aus vier verschiedenen Motiven mit vergoldeten Äderungen zusammen, die in zwei Schachteln mit je 2 Fliesen verpackt sind: Gold Vein 1 und Gold Vein 2.
La decoración Gold Vein consta de cuatro pattern diferentes de vetas doradas, contenidas en dos cajas de 2 piezas cada una: Gold Vein 1 y Gold Vein 2.
Декор Gold Vein включает четыре разных рисунка золотистых прожилок, упакованных в две коробки по 2 штуки в каждой: Gold Vein 1 и Gold Vein 2.



MARVEL

PRO

WALL TILES

Wall Tiles / Rivestimento

WHITEBODY WALL TILES - RECTIFIED MONOCALIBER
RIVESTIMENTI IN PASTA BIANCA - RETTIFICATO MONOCALIBRO

COORDINATED PORCELAIN TILES p. 208



Sizes	Thickness	Surface finish
50x110 cm - 19 ⁵ / ₈ "x43 ¹ / ₄ "	± 8,5 mm	Shiny
40x80 cm - 15 ³ / ₄ "x31 ¹ / ₂ "	± 8,5 mm	Shiny
30,5x91,5 cm - 12"x36"	± 8,5 mm	Shiny
8x31,5 cm - 3 ¹ / ₈ "x12 ³ / ₈ "	± 8,5 mm	Shiny

3D Wall Tiles

Sizes	Thickness	Surface finish
40x80 cm - 15 ³ / ₄ "x31 ¹ / ₂ "	± 10 mm	Shiny

DECORATIVE RANGE / GAMMA DECORATIVA

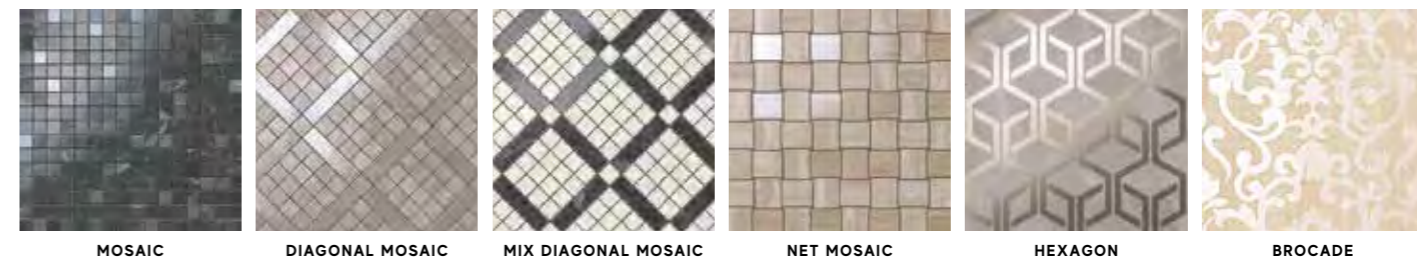

MOSAIC DIAGONAL MOSAIC MIX DIAGONAL MOSAIC NET MOSAIC HEXAGON BROCADE

Marvel Pro Wall Tiles / Rivestimento

SHINY SURFACE / SUPERFICIE LUCIDA



4MPT Marvel Statuario Select 50x110
50x110 - 19⁵/₈"x43³/₄"



LMKT Marvel Statuario Select Brick
8x31,5 - 3¹/₈"x12³/₈"

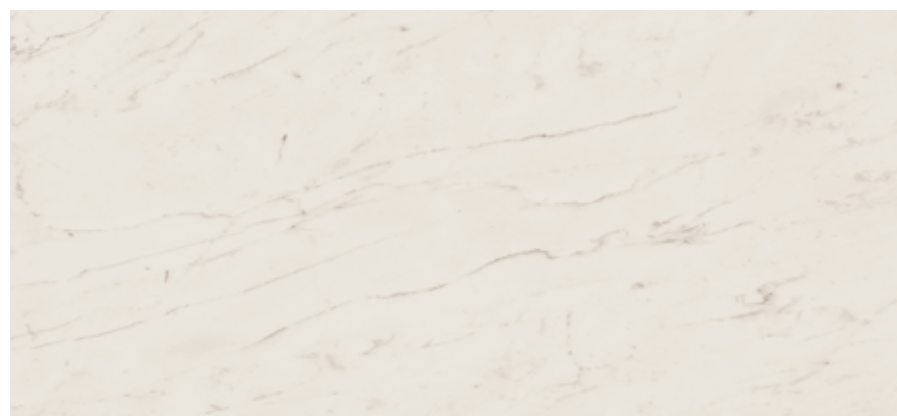

4MPE Marvel Crema Delicata 50x110
50x110 - 19⁵/₈"x43³/₄"



4MPN Marvel Noir St. Laurent 50x110
50x110 - 19⁵/₈"x43³/₄"



LMKN Marvel Noir S. Laurent Brick
8x31,5 - 3¹/₈"x12³/₈"



9M4R Marvel Statuario Select 40x80
40x80 - 15³/₄"x31¹/₂"



9M4E Marvel Crema Delicata 40x80
40x80 - 15³/₄"x31¹/₂"



9M4F Marvel Grey Fleury 40x80
40x80 - 15³/₄"x31¹/₂"



9M4L Marvel Travertino Alabastrino 40x80
40x80 - 15³/₄"x31¹/₂"



9M4O Marvel Noir St. Laurent 40x80
40x80 - 15³/₄"x31¹/₂"



9M4Q Marvel Travertino Silver 40x80
40x80 - 15³/₄"x31¹/₂"



**V3
MODERATE
VARIATION**
Statuario Select



**V2
SLIGHT
VARIATION**
Crema Delicata,
Noir St. Laurent



**V3
MODERATE
VARIATION**
Statuario Select,
Grey Fleury



**V2
SLIGHT
VARIATION**
Crema Delicata,
Travertino Alabastrino,
Travertino Silver,
Noir St. Laurent

Marvel Pro Wall Tiles / Rivestimento

SHINY SURFACE / SUPERFICIE LUCIDA

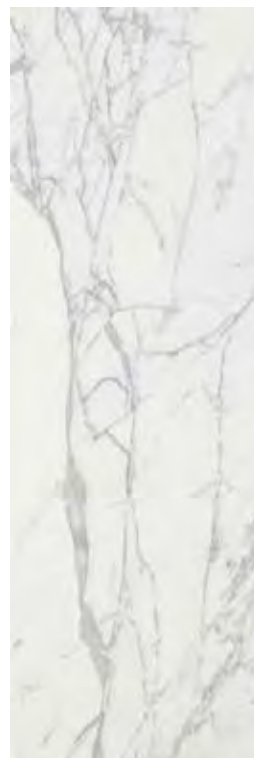

9M3S Marvel Statuario Select 91
30,5x91,5 - 12"x36"



9M3G Marvel Grey Fleury 91
30,5x91,5 - 12"x36"



9M3N Marvel Noir St. Laurent 91
30,5x91,5 - 12"x36"

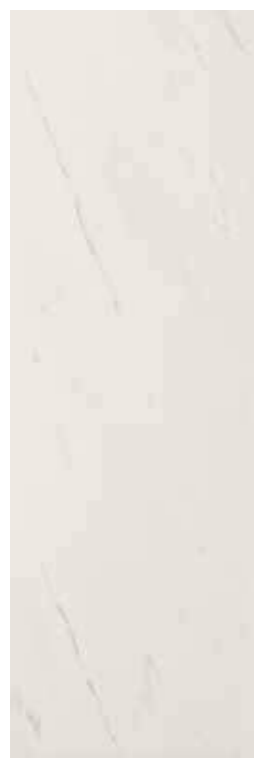

9M3C Marvel Crema Delicata 91
30,5x91,5 - 12"x36"



9M3T Marvel Travertino Alabastrino 91
30,5x91,5 - 12"x36"

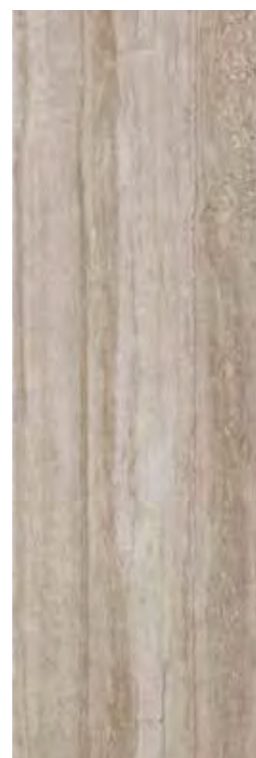

9M3V Marvel Travertino Silver 91
30,5x91,5 - 12"x36"



**V3
MODERATE
VARIATION**
Statuario Select,
Grey Fleury



**V2
SLIGHT
VARIATION**
Crema Delicata,
Travertino Alabastrino,
Travertino Silver,
Noir St. Laurent

Marvel Pro 3D Wall Tiles / Rivestimento 3D

SHINY SURFACE / SUPERFICIE LUCIDA



9MSS Marvel Statuario Select Ribbon
40x80 - 15³/₄"x31¹/₂"



9MSR Marvel Crema Delicata Ribbon
40x80 - 15³/₄"x31¹/₂"



9MSG Marvel Grey Fleury Ribbon
40x80 - 15³/₄"x31¹/₂"



9MSN Marvel Noir St. Laurent Ribbon
40x80 - 15³/₄"x31¹/₂"



SHINY SURFACE | SUPERFICIE LUCIDA | Surface brillante | Glänzende oberfläche | Superficie brillante | Глянec поверхность



**V3
MODERATE
VARIATION**
Ribbon Statuario Select,
Ribbon Grey Fleury



**V2
SLIGHT
VARIATION**
Ribbon Crema Delicata,
Ribbon Noir St. Laurent

WALL TILES

WALL TILES

SHINY SURFACE | SUPERFICIE LUCIDA | Surface brillante | Glänzende oberfläche | Superficie brillante | Глянec поверхность

Marvel Pro Wall Tiles / Rivestimento

DECOR RANGE / GAMMA DECORI

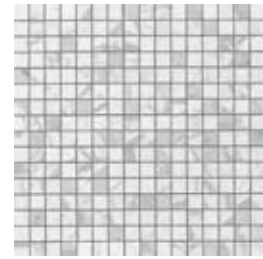

9MVS Marvel Statuario Select Mosaic
30,5x30,5 - 12"x12"

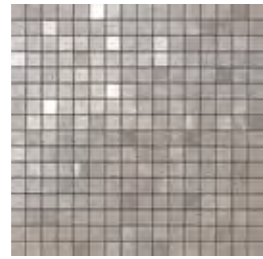

9MVE Marvel Grey Fleury Mosaic
30,5x30,5 - 12"x12"

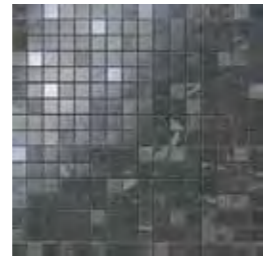

9MVN Marvel Noir St. Laurent Mosaic
30,5x30,5 - 12"x12"

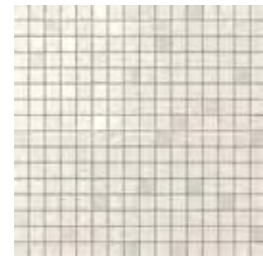
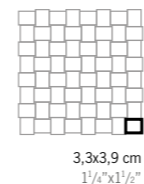
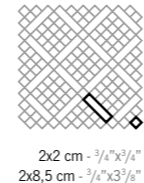
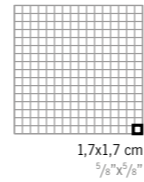

9MVC Marvel Crema Delicata Mosaic
30,5x30,5 - 12"x12"

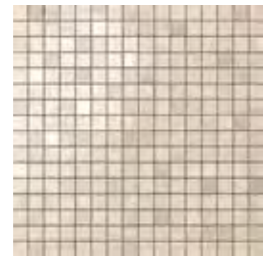

9MVT Marvel Travertino Alabastrino Mosaic
30,5x30,5 - 12"x12"

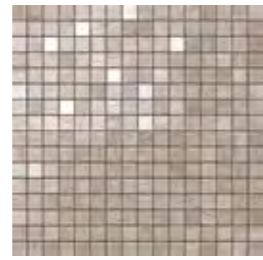

9MVV Marvel Travertino Silver Mosaic
30,5x30,5 - 12"x12"



9MVD Marvel Grey Fleury Diagonal Mosaic
30,5x30,5 - 12"x12"



9MVA Marvel Travertino Alabastrino Diagonal Mosaic
30,5x30,5 - 12"x12"



9MVB Marvel Travertino Silver Diagonal Mosaic
30,5x30,5 - 12"x12"



9MVH Marvel Noir Mix Diagonal Mosaic
30,5x30,5 - 12"x12"

Noir St. Laurent + Statuario Select

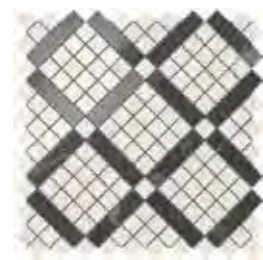

9MVF Marvel Crema Mix Diagonal Mosaic
30,5x30,5 - 12"x12"

Crema Delicata + Noir St. Laurent



9MVP Marvel Grey Fleury Net Mosaic
30,5x30,5 - 12"x12"



9MVM Marvel Travertino Silver Net Mosaic
30,5x30,5 - 12"x12"



8MHG Marvel Grey Fleury Hexagon
40x80 - 15 3/4"x31 1/2"



LVGW Marvel Gold White •
7,8x30,5 - 3 1/8"x12"



AVGW Marvel Gold White A.E. •
7,8x1,2 - 3 1/8"x1/2"



LVGB Marvel Gold Black •
7,8x30,5 - 3 1/8"x12"



AVGB Marvel Gold Black A.E. •
7,8x1,2 - 3 1/8"x1/2"

• DECOR WITH GOLD INSERT.
DECORO CON INSERTO IN ORO.
Décor avec insert en OR.
Dekor mit Einlage GOLD.
Decoración con aplicación de ORO.
Декор с ЗОЛОТОЙ вставкой.

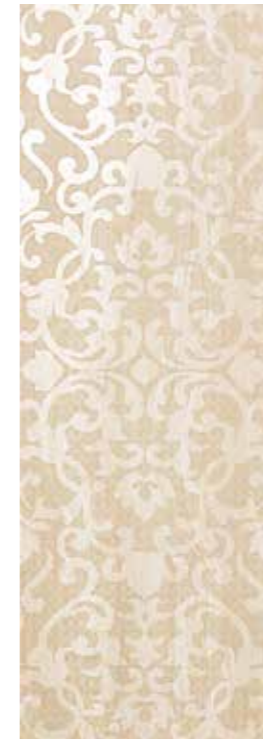

9MBT Marvel Travertino Alabastrino Brocade
30,5x91,5 - 12"x36"



9MBN Marvel Noir St. Laurent Brocade
30,5x91,5 - 12"x36"

TRIM TILES / PEZZI SPECIALI

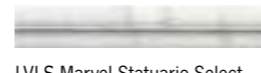

LVLS Marvel Statuario Select London
5x30,5 - 2"x12"

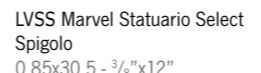

LVSS Marvel Statuario Select Spigolo
0,85x30,5 - 3/8"x12"



LVAS Marvel Statuario Select Alzata
20x30,5 - 7 7/8"x12"

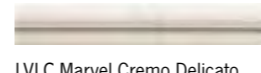

LVLC Marvel Crema Delicata London
5x30,5 - 2"x12"

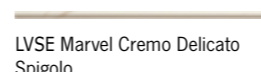

LVSE Marvel Crema Delicata Spigolo
0,85x30,5 - 3/8"x12"



LVAC Marvel Crema Delicata Alzata
20x30,5 - 7 7/8"x12"



AVLS Marvel London A.E.
5x2,5 - 2"x1"



AVSS Marvel Spigolo A.E.
0,85x0,85 - 3/8"x3/8"



AVAA Marvel Alzata A.E.
1,5x20 - 5/8"x7 7/8"



AVLC Marvel London A.E.
5x2,5 - 2"x1"



AVSC Marvel Spigolo A.E.
0,85x0,85 - 3/8"x3/8"



AVAC Marvel Alzata A.E.
1,5x20 - 5/8"x7 7/8"

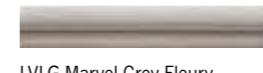

LVLG Marvel Grey Fleury London
5x30,5 - 2"x12"



LVSF Marvel Grey Fleury Spigolo
0,85x30,5 - 3/8"x12"



LVAG Marvel Grey Fleury Alzata
20x30,5 - 7 7/8"x12"

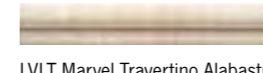

LVLT Marvel Travertino Alabastrino London
5x30,5 - 2"x12"

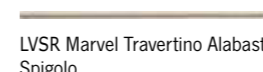

LVSR Marvel Travertino Alabastrino Spigolo
0,85x30,5 - 3/8"x12"



LVAT Marvel Travertino Alabastrino Alzata
20x30,5 - 7 7/8"x12"



AVLG Marvel London A.E.
5x2,5 - 2"x1"



AVSG Marvel Spigolo A.E.
0,85x0,85 - 3/8"x3/8"



AVAF Marvel Alzata A.E.
1,5x20 - 5/8"x7 7/8"



AVLT Marvel London A.E.
5x2,5 - 2"x1"



AVST Marvel Spigolo A.E.
0,85x0,85 - 3/8"x3/8"



AVAT Marvel Alzata A.E.
1,5x20 - 5/8"x7 7/8"

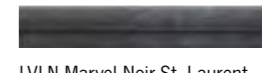

LVLN Marvel Noir St. Laurent London
5x30,5 - 2"x12"

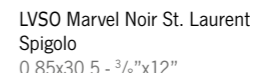

LVSO Marvel Noir St. Laurent Spigolo
0,85x30,5 - 3/8"x12"



LVAN Marvel Noir St. Laurent Alzata
20x30,5 - 7 7/8"x12"

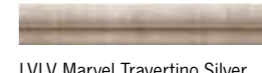

LVLV Marvel Travertino Silver London
5x30,5 - 2"x12"

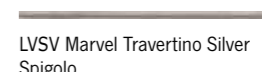

LVSV Marvel Travertino Silver Spigolo
0,85x30,5 - 3/8"x12"



LVAV Marvel Travertino Silver Alzata
20x30,5 - 7 7/8"x12"



AVLN Marvel London A.E.
5x2,5 - 2"x1"



AVSN Marvel Spigolo A.E.
0,85x0,85 - 3/8"x3/8"



AVAN Marvel Alzata A.E.
1,5x20 - 5/8"x7 7/8"



AVLV Marvel London A.E.
5x2,5 - 2"x1"



AVSV Marvel Spigolo A.E.
0,85x0,85 - 3/8"x3/8"



AVAV Marvel Alzata A.E.
1,5x20 - 5/8"x7 7/8"

MARVEL

STONE

WALL TILES

Wall Tiles / Rivestimento | Marble Look

WHITEBODY WALL TILES - RECTIFIED MONOCALIBER
RIVESTIMENTI IN PASTA BIANCA - RETTIFICATO MONOCALIBRO

COORDINATED PORCELAIN TILES MARBLE LOOK p. 222

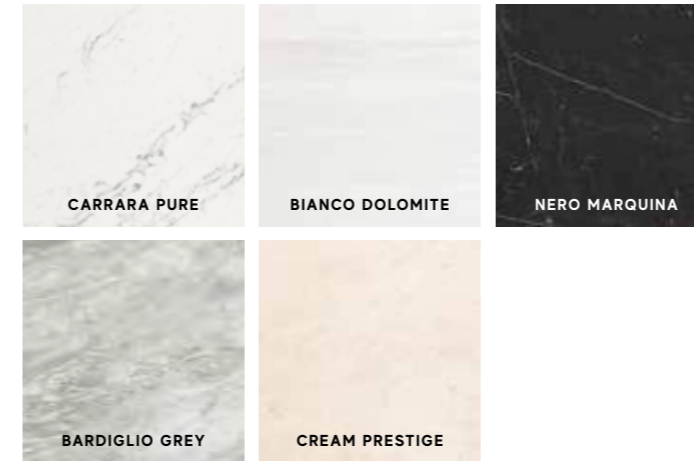

Sizes	Thickness	Surface finish
50x110 cm - 19 ⁵ / ₈ "x43 ¹ / ₄ "	± 8,5 mm	Shiny
40x80 cm - 15 ³ / ₄ "x31 ¹ / ₂ "	± 8,5 mm	Shiny

DECORATIVE RANGE / GAMMA DECORATIVA



Wall Tiles / Rivestimento | Stone Look

WHITEBODY WALL TILES - RECTIFIED MONOCALIBER
RIVESTIMENTI IN PASTA BIANCA - RETTIFICATO MONOCALIBRO

COORDINATED PORCELAIN TILES STONE LOOK p. 280



Sizes	Thickness	Surface finish
50x110 cm - 19 ⁵ / ₈ "x43 ¹ / ₄ "	± 8,5 mm	Matte
40x80 cm - 15 ³ / ₄ "x31 ¹ / ₂ "	± 8,5 mm	Matte

3D Wall Tiles

Sizes	Thickness	Surface finish
50x110 cm - 19 ⁵ / ₈ "x43 ¹ / ₄ "	± 11 mm	Matte
40x80 cm - 15 ³ / ₄ "x31 ¹ / ₂ "	± 10 mm	Matte

DECORATIVE RANGE / GAMMA DECORATIVA



TUMBLED MOSAIC

Marvel Stone Wall Tiles / Rivestimento | Marble Look

SHINY SURFACE / SUPERFICIE LUCIDA



AZOQ Marvel Carrara Pure 110
50x110 - 19⁵/₈"x43³/₄"



9MSF Marvel Carrara Pure 40x80
40x80 - 15³/₄"x31¹/₂"



AZOT Marvel Bardiglio Grey 110
50x110 - 19⁵/₈"x43³/₄"



9MSD Marvel Bardiglio Grey 40x80
40x80 - 15³/₄"x31¹/₂"



AZOR Marvel Bianco Dolomite 110
50x110 - 19⁵/₈"x43³/₄"



9MSB Marvel Bianco Dolomite 40x80
40x80 - 15³/₄"x31¹/₂"

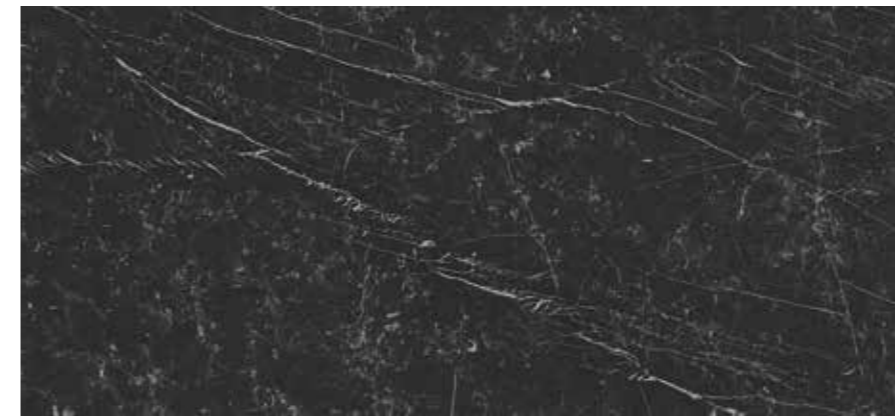

AZOU Marvel Nero Marquina 110
50x110 cm - 19⁵/₈"x43³/₄"



9MSM Marvel Nero Marquina 40x80
40x80 cm - 15³/₄"x31¹/₂"



AZOS Marvel Cream Prestige 110
50x110 - 19⁵/₈"x43³/₄"



9MSI Marvel Cream Prestige 40x80
40x80 cm - 15³/₄"x31¹/₂"

TRIM TILES / PEZZI SPECIALI



LSLH Marvel Carrara Pure London
5x30,5 - 2"x12"



ALSF Marvel Carrara Pure London A.E.
5x2,5 - 2"x1"



LSLO Marvel Bardiglio Grey London
5x30,5 - 2"x12"



ALSG Marvel Bardiglio Grey London A.E.
5x2,5 - 2"x1"

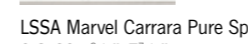

LSSA Marvel Carrara Pure Spigolo
0,8x20 - 3¹/₈"x7⁷/₈"



AS1A Marvel Carrara Pure Spigolo A.E.
0,8x0,8 - 3¹/₈"x3³/₈"

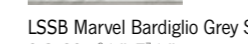

LSSB Marvel Bardiglio Grey Spigolo
0,8x20 - 3¹/₈"x7⁷/₈"



AS1G Marvel Bardiglio Grey Spigolo A.E.
0,8x0,8 - 3¹/₈"x3³/₈"



LSLM Marvel Bianco Dolomite London
5x30,5 - 2"x12"



ALSD Marvel Bianco Dolomite London A.E.
5x2,5 - 2"x1"



LSLN Marvel Nero Marquina London
5x30,5 - 2"x12"



ALSN Marvel Nero Marquina London A.E.
5x2,5 - 2"x1"



LSSD Marvel Bianco Dolomite Spigolo
0,8x20 - 3¹/₈"x7⁷/₈"



AS1D Marvel Bianco Dolomite Spigolo A.E.
0,8x0,8 - 3¹/₈"x3³/₈"

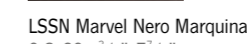

LSSN Marvel Nero Marquina Spigolo
0,8x20 - 3¹/₈"x7⁷/₈"



AS1N Marvel Nero Marquina Spigolo A.E.
0,8x0,8 - 3¹/₈"x3³/₈"



LSLE Marvel Cream Prestige London
5x30,5 - 2"x12"



ALSE Marvel Cream Prestige London A.E.
5x2,5 cm - 2"x1"

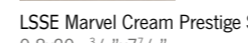

LSSE Marvel Cream Prestige Spigolo
0,8x20 - 3¹/₈"x7⁷/₈"



AS1E Marvel Cream Prestige Spigolo A.E.
0,8x0,8 - 3¹/₈"x3³/₈"



V2
SLIGHT
VARIATION
Carrara Pure,
Bianco Dolomite,
Cream Prestige



V2
SLIGHT
VARIATION
Bardiglio Grey,
Nero Marquina

Marvel Stone Wall Tiles / Rivestimento | Marble Look

DECOR RANGE / GAMMA DECORI

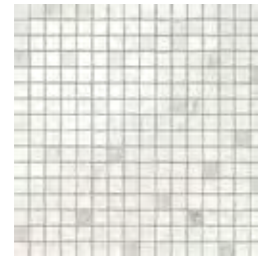

9MQC Marvel Carrara Pure Mosaic Q
30,5x30,5 - 12"x12"

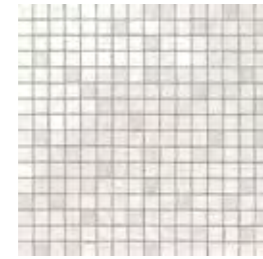

9MQB Marvel Bianco Dolomite Mosaic Q
30,5x30,5 - 12"x12"

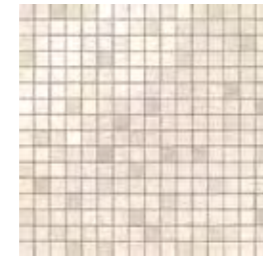

9MQE Marvel Cream Prestige Mosaic Q
30,5x30,5 - 12"x12"

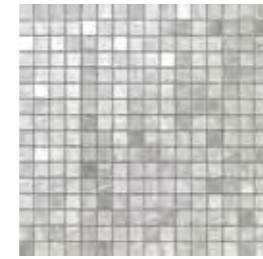

9MQA Marvel Bardiglio Grey Mosaic Q
30,5x30,5 - 12"x12"

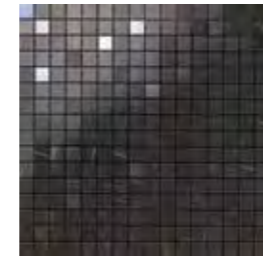

9MQN Marvel Nero Marquina Mosaic Q
30,5x30,5 - 12"x12"

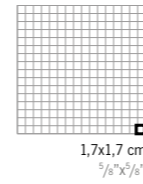

1,7x1,7 cm
5/8"x5/8"



9SHC Marvel Carrara Pure Herringbone Wall
30,5x30 - 12"x11 3/4"



9SHD Marvel Bianco Dolomite Herringbone Wall
30,5x30 - 12"x11 3/4"



9SHE Marvel Cream Prestige Herringbone Wall
30,5x30 - 12"x11 3/4"



9SHB Marvel Bardiglio Grey Herringbone Wall
30,5x30 - 12"x11 3/4"



9SHN Marvel Nero Marquina Herringbone Wall
30,5x30 - 12"x11 3/4"

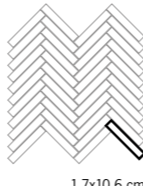

1,7x10,6 cm
5/8"x4 1/8"



9STA Marvel Carrara Pure Twist
30,5x30,5 - 12"x12"



9STD Marvel Bianco Dolomite Twist
30,5x30,5 - 12"x12"



9STE Marvel Cream Prestige Twist
30,5x30,5 - 12"x12"



9STB Marvel Bardiglio Grey Twist
30,5x30,5 - 12"x12"



9STN Marvel Nero Marquina Twist
30,5x30,5 - 12"x12"



2,5x6,8 cm
1"x2 1/8"



9SCA Marvel Carrara Pure Chevron Wall
30,5x25 - 12"x9 7/8"



9SCD Marvel Bianco Dolomite Chevron Wall
30,5x25 - 12"x9 7/8"



9SCN Marvel Nero Marquina Chevron Wall
30,5x25 - 12"x9 7/8"

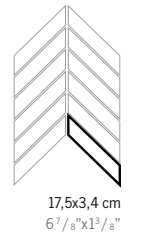

17,5x3,4 cm
6 7/8"x1 1/8"



9SCL Marvel Chevron Cold Wall
30,5x25 - 12"x9 7/8"
Carrara Pure + Nero Marquina



9SCW Marvel Chevron Warm Wall
30,5x25 - 12"x9 7/8"
Bianco Dolomite + Nero Marquina



9SCM Marvel Chevron Mix Wall
30,5x25 - 12"x9 7/8"
Carrara Pure + Bardiglio Grey + Nero Marquina

• **DECOR WITH GOLD INSERT.**
DECORO CON INSERTO IN ORO.
Décor avec insert en OR.
Dekor mit Einlage GOLD.
Decoración con aplicación de ORO.
Декор с ЗОЛОТОЙ вставкой.



ASEK Marvel Greca Gold •
7,8x30,5 - 3 1/8"x12"



ASEM Marvel Greca A.E. •
7,8x1,2 - 3 1/8"x1 1/2"

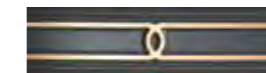

LVGB Marvel Gold Black •
7,8x30,5 - 3 1/8"x12"



AVGB Marvel Gold Black A.E. •
7,8x1,2 - 3 1/8"x1 1/2"



LVGW Marvel Gold White •
7,8x30,5 - 3 1/8"x12"



AVGW Marvel Gold White A.E. •
7,8x1,2 - 3 1/8"x1 1/2"



Marvel Stone Wall Tiles / Rivestimento | Stone Look

MATTE SURFACE / SUPERFICIE MATT



AZOV Marvel Clauzetto White 110
50x110 - 19⁵/₈"x43³/₄"



9MSH Marvel Clauzetto White 40x80
40x80 - 15³/₄"x31¹/₂"



AZOW Marvel Desert Beige 110
50x110 - 19⁵/₈"x43³/₄"



9MSL Marvel Desert Beige 40x80
40x80 - 15³/₄"x31¹/₂"



AZOX Marvel Cardoso Elegant 110
50x110 - 19⁵/₈"x43³/₄"



9MSE Marvel Cardoso Elegant 40x80
40x80 - 15³/₄"x31¹/₂"

TRIM TILES / PEZZI SPECIALI

LSSU Marvel
Clauzetto White Spigolo
0,8x20 - 3¹/₈"x7⁷/₈"

AS1C Marvel
Clauzetto White Spigolo A.E.
0,8x0,8 - 3¹/₈"x3¹/₈"

LSSS Marvel
Desert Beige Spigolo
0,8x20 - 3¹/₈"x7⁷/₈"

AS1T Marvel
Desert Beige Spigolo A.E.
0,8x0,8 - 3¹/₈"x3¹/₈"

LSSO Marvel
Cardoso Elegant Spigolo
0,8x20 - 3¹/₈"x7⁷/₈"

AS1O Marvel
Cardoso Elegant Spigolo A.E.
0,8x0,8 - 3¹/₈"x3¹/₈"



**V2
SLIGHT
VARIATION**
Clauzetto White,
Cardoso Elegant,
Desert Beige

Marvel Stone 3D Wall Tiles / Rivestimento 3D | Stone Look

MATTE SURFACE / SUPERFICIE MATT



AZOY Marvel 3D Plot Clauzetto White 110
50x110 - 19⁵/₈"x43³/₄"



AZOJ Marvel 3D Mesh Clauzetto White 40x80
40x80 - 15³/₄"x31¹/₂"



AZOZ Marvel 3D Plot Desert Beige 110
50x110 - 19⁵/₈"x43³/₄"



AZOK Marvel 3D Mesh Desert Beige 40x80
40x80 - 15³/₄"x31¹/₂"

TRIM TILES / PEZZI SPECIALI

LS1C Marvel Clauzetto White Spigolo 10 mm *
1x20 - 3¹/₈"x7⁷/₈"

LS1D Marvel Desert Beige Spigolo 10 mm *
1x20 - 3¹/₈"x7⁷/₈"

DECOR RANGE / GAMMA DECORI



9STL Marvel Clauzetto White
Tumbled Mosaic
30x30 - 11³/₄"x11³/₄"



9STT Marvel Desert Beige
Tumbled Mosaic
30x30 - 11³/₄"x11³/₄"

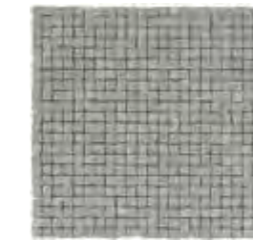

9STO Marvel Cardoso Elegant
Tumbled Mosaic
30x30 - 11³/₄"x11³/₄"

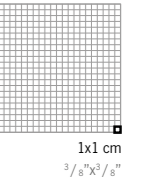

1x1 cm
3¹/₈"x3¹/₈"

* THESE PARTS ARE SUPPLIED TO ORDER . I PEZZI SONO DISPONIBILI SU ORDINAZIONE
Les pièces sont disponibles sur commande | Die Teile sind auf Bestellung lieferbar | Las piezas se hacen por encargo | Изготавливаются на заказ

The 10 mm edge matches three-dimensional wall tiles having a 10-11 mm thickness / Lo spigolo 10 mm si abbina a rivestimenti tridimensionali di spessore 10-11 mm / Le bord 10 mm s'adapte aux revêtements tridimensionnels épaisseur 10-11 mm / Die 10 mm Kante ist mit dreidimensionalen Wandfliesen mit einer Dicke von 10-11 mm kombinierbar / La arista de 10 mm se combina con revestimientos tridimensionales de 10-11 mm de grosor / Угловой элемент 10 мм сочетается с трехмерной настенной плиткой толщиной 10-11 мм

MATTE SURFACE | SUPERFICIE MATT | Surface Mat | Matt oberfläche | Superficie Mate | Матовая поверхность



**V2
SLIGHT
VARIATION**
3D Mesh Clauzetto White,
3D Plot Clauzetto White,
3D Mesh Desert Beige,
3D Plot Desert Beige



mek
WALL TILES



Wall Tiles / Rivestimento

WHITEBODY WALL TILES - RECTIFIED MONOCALIBER
RIVESTIMENTI IN PASTA BIANCA - RETTIFICATO MONOCALIBRO

COORDINATED PORCELAIN TILES p. 158

Sizes	Thickness	Surface finish
50x110 cm - 19 ⁵ / ₈ "x43 ¹ / ₄ "	± 8,5 mm	Matte

3D Wall Tiles

Sizes	Thickness	Surface finish
50x110 cm - 19 ⁵ / ₈ "x43 ¹ / ₄ "	± 11 mm	Matte

DECORATIVE RANGE / GAMMA DECORATIVA



WHITEBODY WALL TILES | RIVESTIMENTI IN PASTA BIANCA | Revêtements en pâte blanche | Weißscherbige Wandfliesen | Revestimientos en pasta blanca | Настенная плитка из белой глины
RECTIFIED MONOCALIBER | RETTIFICATO MONOCALIBRO | Rectifié mono-calibre | Geschliffen einkalibrig | Rectificado monocalibré | Ретицированный в одном калибре

Mek Wall Tiles / Rivestimento

MATTE SURFACE / SUPERFICIE MATT

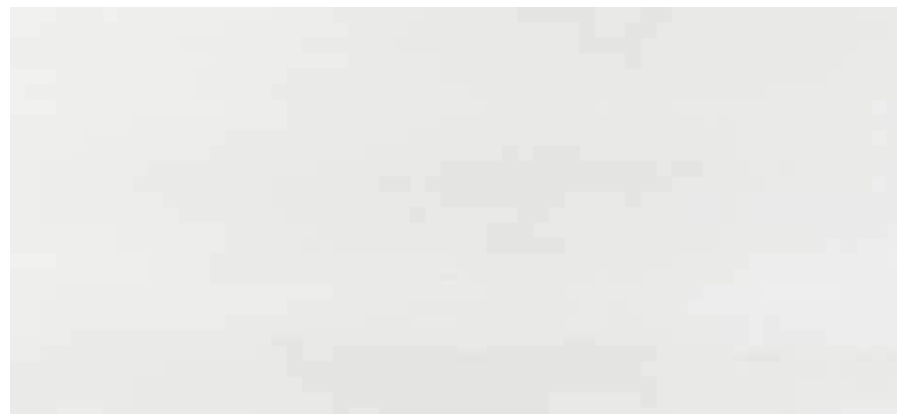

4MKL Mek Light 50x110 50x110 cm - 19⁵/₈"x43³/₄"



4MKM Mek Medium 50x110 50x110 cm - 19⁵/₈"x43³/₄"



4MKR Mek Rose 50x110 50x110 cm - 19⁵/₈"x43³/₄"



4MKB Mek Blue 50x110 50x110 cm - 19⁵/₈"x43³/₄"

TRIM TILES / PEZZI SPECIALI

LMPK Mek Light Spigolo
0,8x25 cm - 3¹/₈"x8¹/₈"

AMKL Mek Light Spigolo A.E.
0,8x0,8 cm - 3¹/₈"x3¹/₈"

LMPH Mek Medium Spigolo
0,8x25 cm - 3¹/₈"x8¹/₈"

AMKM Mek Medium Spigolo A.E.
0,8x0,8 cm - 3¹/₈"x3¹/₈"

LMPQ Mek Rose Spigolo
0,8x25 cm - 3¹/₈"x8¹/₈"

AMKR Mek Rose Spigolo A.E.
0,8x0,8 cm - 3¹/₈"x3¹/₈"

LMPU Mek Blue Spigolo
0,8x25 cm - 3¹/₈"x8¹/₈"

AMKU Mek Blue Spigolo A.E.
0,8x0,8 cm - 3¹/₈"x3¹/₈"

V2 SLIGHT VARIATION

Light,
Medium,
Rose,
Blue

Mek 3D Wall Tiles / Rivestimento 3D

MATTE SURFACE / SUPERFICIE MATT



4MKI Mek 3D Fold Light 50x110 cm - 19⁵/₈"x43³/₄"



4MKE Mek 3D Fold Medium 50x110 cm - 19⁵/₈"x43³/₄"



4MKO Mek 3D Ultra Blade Rose 50x110 cm - 19⁵/₈"x43³/₄"

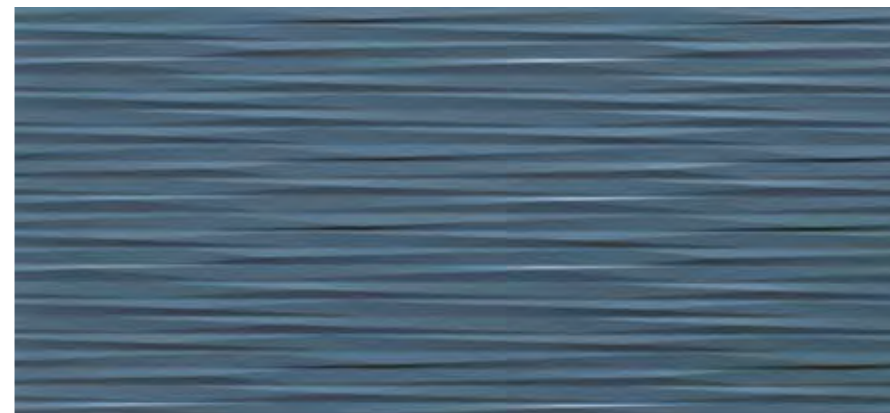

4MKU Mek 3D Ultra Blade Blue 50x110 cm - 19⁵/₈"x43³/₄"

TRIM TILES / PEZZI SPECIALI

LM1L Mek Light Spigolo 10mm *
1x20 cm - 3⁷/₈"x7¹/₈"

LM1M Mek Medium Spigolo 10mm *
1x20 cm - 3⁷/₈"x7¹/₈"

LM1R Mek Rose Spigolo 10mm *
1x20 cm - 3⁷/₈"x7¹/₈"

LM1U Mek Blue Spigolo 10mm *
1x20 cm - 3⁷/₈"x7¹/₈"

* THESE PARTS ARE SUPPLIED TO ORDER
I PEZZI SONO DISPONIBILI SU ORDINAZIONE
Les pièces sont disponibles sur commande
Die Teile sind auf Bestellung lieferbar
Las piezas se hacen por encargo
Изготавливаются на заказ

V2 SLIGHT VARIATION

3D Fold Light
3D Fold Medium,
3D Ultra Blade Rose,
3D Ultra Blade Blue

The 10 mm edge matches three-dimensional wall tiles having a 10-11 mm thickness / Lo spigolo 10 mm si abbinna a rivestimenti tridimensionali di spessore 10-11 mm / Le bord 10 mm s'adapte aux revêtements tridimensionnels épaisseur 10-11 mm / Die 10 mm Kante ist mit dreidimensionalen Wandfliesen mit einer Dicke von 10-11 mm kombinierbar / La arista de 10 mm se combina con revestimientos tridimensionales de 10-11 mm de grosor / Угловой элемент 10 мм сочетается с трехмерной настенной плиткой толщиной 10-11 мм

MATTE SURFACE | SUPERFICIE MATT | Surface Mat | Matt oberfläche | Superficie Mate | Матовая поверхность

535

Mek Wall Tiles / Rivestimento

DECOR RANGE / GAMMA DECORI

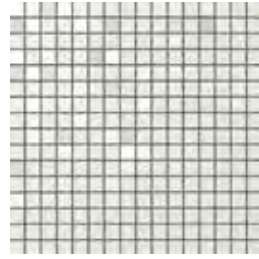

9MQL Mek Light Mosaico Q Wall
30,5x30,5 - 12"x12"

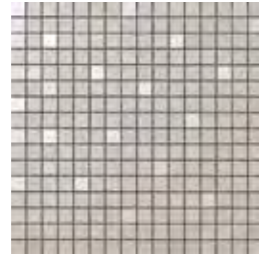

9MQM Mek Medium Mosaico Q Wall
30,5x30,5 - 12"x12"

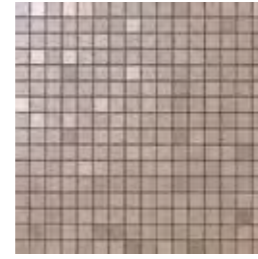

9MQR Mek Rose Mosaico Q Wall
30,5x30,5 - 12"x12"

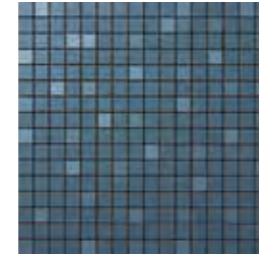

9MQU Mek Blue Mosaico Q Wall
30,5x30,5 - 12"x12"

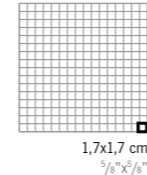

9MCH Mek Light Mosaico
Chevron Wall
30,5x30,5 - 12"x12"



9MCE Mek Medium Mosaico
Chevron Wall
30,5x30,5 - 12"x12"



9MCR Mek Rose Mosaico
Chevron Wall
30,5x30,5 - 12"x12"

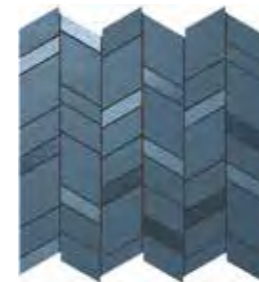

9MCU Mek Blue Mosaico
Chevron Wall
30,5x30,5 - 12"x12"

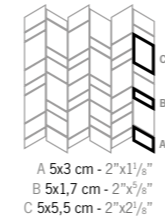

9MDL Mek Light Mosaico
Diamond Wall
30,5x30,5 - 12"x12"



9MDM Mek Medium Mosaico
Diamond Wall
30,5x30,5 - 12"x12"



9MDR Mek Rose Mosaico
Diamond Wall
30,5x30,5 - 12"x12"



9MDU Mek Blue Mosaico •
Diamond Gold Wall
30,5x30,5 - 12"x12"

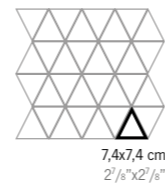

4MKC Mek Gold Circles •
29x31 - 11 3/8" x 12 1/4"



• **DECOR WITH GOLD INSERT.**
 DECORO CON INSERTO IN ORO.
 Décor avec insert en OR.
 Dekor mit Einlage GOLD.
 Decoración con aplicación de ORO.
 Декор с ЗОЛОТОЙ вставкой.



4MHO Mek Rose Hexagon •
50x110 - 19 5/8" x 43 3/4"



4MWO Mek Rose Wallpaper
50x110 - 19 5/8" x 43 3/4"



4MWU Mek Blue Wallpaper
50x110 - 19 5/8" x 43 3/4"





RAW

WALL TILES

Wall Tiles / Rivestimento

WHITEBODY WALL TILES - RECTIFIED MONOCALIBER
RIVESTIMENTI IN PASTA BIANCA - RETTIFICATO MONOCALIBRO

COORDINATED PORCELAIN TILES p. 166



Sizes	Thickness	Surface finish
50x110 cm - 19 ⁵ / ₈ "x43 ¹ / ₄ "	± 8,5 mm	Matte

3D Wall Tiles

Sizes	Thickness	Surface finish
50x110 cm - 19 ⁵ / ₈ "x43 ¹ / ₄ "	± 10 mm	Matte

DECORATIVE RANGE / GAMMA DECORATIVA



WHITEBODY WALL TILES | RIVESTIMENTI IN PASTA BIANCA | Revêtements en pâte blanche | Weißscherbige Wandfliesen | Revestimientos en pasta blanca | Настенная плитка из белой глины
RECTIFIED MONOCALIBER | RETTIFICATO MONOCALIBRO | Rectifié mono-calibre | Geschliffen einkalbrig | Rectificado monocalibre | Ретифицированный в одном калибре

Raw Wall Tiles / Rivestimento

MATTE SURFACE / SUPERFICIE MATT



4R1W Raw White 50x110
50x110 cm - 19⁵/₈"x43³/₄"



4R1P Raw Pearl 50x110
50x110 cm - 19⁵/₈"x43³/₄"



4R1S Raw Sand 50x110
50x110 cm - 19⁵/₈"x43³/₄"



4R1B Raw Blue 50x110
50x110 cm - 19⁵/₈"x43³/₄"



4R1R Raw Rose 50x110
50x110 cm - 19⁵/₈"x43³/₄"



4R1E Raw Petroleum 50x110
50x110 cm - 19⁵/₈"x43³/₄"



**V2
SLIGHT
VARIATION**
White,
Pearl,
Sand



**V2
SLIGHT
VARIATION**
Blue,
Rose,
Petroleum

Raw 3D Wall Tiles / Rivestimento 3D

MATTE SURFACE / SUPERFICIE MATT



4R3W Raw 3D Scratch White 50x110
50x110 cm - 19⁵/₈"x43³/₄"



4R3P Raw 3D Scratch Pearl 50x110
50x110 cm - 19⁵/₈"x43³/₄"

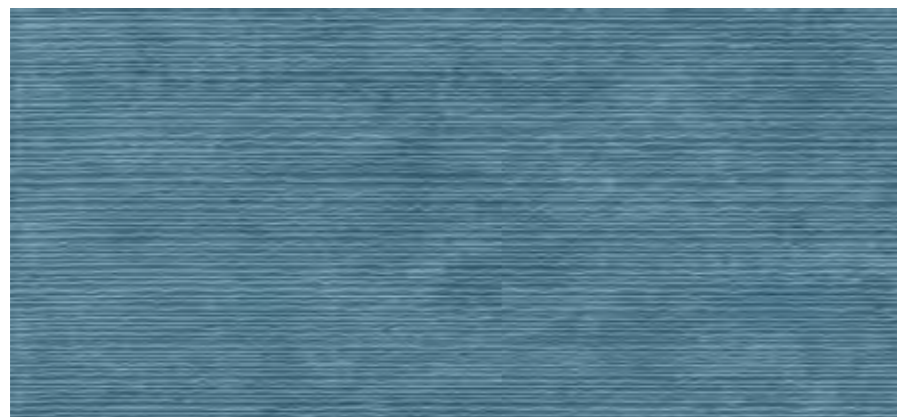

4R3B Raw 3D Scratch Blue 50x110
50x110 cm - 19⁵/₈"x43³/₄"

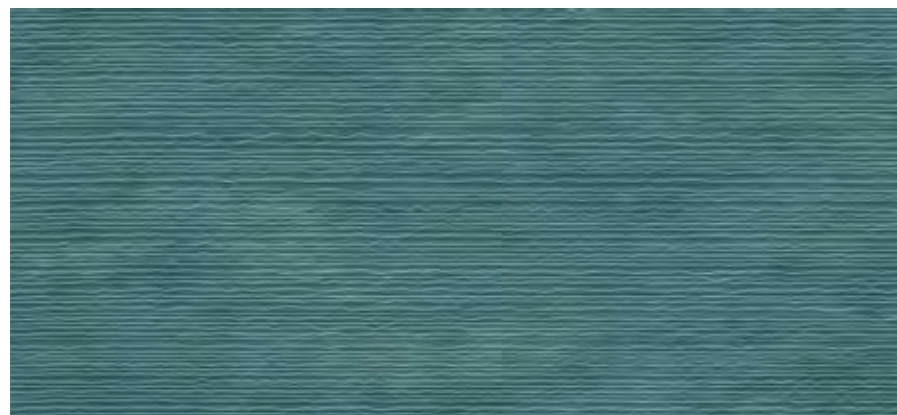

4R3E Raw 3D Scratch Petroleum 50x110
50x110 cm - 19⁵/₈"x43³/₄"

Raw Wall Tiles / Rivestimento

DECOR RANGE / GAMMA DECORI



4RGP Raw Pearl Gold ♦
50x110 cm - 19⁵/₈"x43³/₄"



4RGS Raw Sand Gold ♦
50x110 cm - 19⁵/₈"x43³/₄"



4RGB Raw Blue Gold ♦
50x110 cm - 19⁵/₈"x43³/₄"



V2
SLIGHT
VARIATION

White,
Pearl,
Sand,
Rose,
Petroleum

♦ Contains gold. The use of a common mild detergent is recommended. Avoid using acidic or alkaline products, waxes, steel wool, or abrasives. / Parti in oro. Si consiglia l'utilizzo di un comune detergente neutro. Evitare l'utilizzo di prodotti acidi o alcalini, ceranti, pagliette di metallo o abrasive. / Parties dorées. Nous vous conseillons d'utiliser des détergents neutres courants. Éviter l'utilisation de cires et de produits acides ou alcalins, ainsi que les pailles métalliques ou abrasives. / Teile aus Gold. Es empfiehlt sich, ein haushaltsübliches, neutrales Reinigungsmittel zu verwenden. Saure oder alkalische Produkte, Wachs sowie Metallwolle- bzw. Scheuerschwämme sind zu vermeiden. / Partes doradas. Recomendamos utilizar un detergente neutro común. Hay que evitar el uso de productos ácidos o alcalinos, ceras y estropajos de metal o abrasivos. / Золотые детали. Рекомендуется чистить обычным нейтральным моющим средством. Не рекомендуется использовать кислотные, щелочные, восковые средства, а также металлические мочалки.

Raw Wall Tiles / Rivestimento

DECOR RANGE / GAMMA DECORI



9RTW Raw White Twist *
35,8x31 - 14¹/₈"x12¹/₄"



9RTP Raw Pearl Twist *
35,8x31 - 14¹/₈"x12¹/₄"



9RTS Raw Sand Twist *
35,8x31 - 14¹/₈"x12¹/₄"



9RTB Raw Blue Twist *
35,8x31 - 14¹/₈"x12¹/₄"

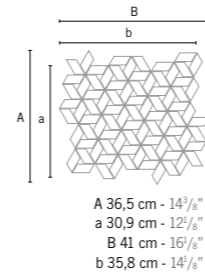

9RFW Raw White Flag *
31,1x31,6 - 12¹/₄"x12¹/₂"



9RFP Raw Pearl Flag *
31,1x31,6 - 12¹/₄"x12¹/₂"



9RFS Raw Sand Flag *
31,1x31,6 - 12¹/₄"x12¹/₂"



9RFB Raw Blue Flag *
31,1x31,6 - 12¹/₄"x12¹/₂"



9RFR Raw Rose Flag *
31,1x31,6 - 12¹/₄"x12¹/₂"



9RFE Raw Petroleum Flag *
31,1x31,6 - 12¹/₄"x12¹/₂"



9RTR Raw Rose Twist *
35,8x31 - 14¹/₈"x12¹/₄"



9RTE Raw Petroleum Twist *
35,8x31 - 14¹/₈"x12¹/₄"



9RBW Raw White Block *
28x28 - 11"x11"



9RBP Raw Pearl Block *
28x28 - 11"x11"



9RBS Raw Sand Block *
28x28 - 11"x11"



9RBB Raw Blue Block *
28x28 - 11"x11"

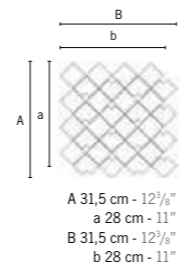

9RBO Raw Rose Block *
28x28 - 11"x11"



9RBE Raw Petroleum Block *
28x28 - 11"x11"

TRIM TILES / PEZZI SPECIALI

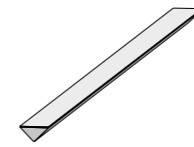

1,4x50 cm - 5⁵/₈"x19⁵/₈"

LR1W Raw White Corner 50 *

LR1P Raw Pearl Corner 50 *

LR1S Raw Sand Corner 50 *

LR1B Raw Blue Corner 50 *

LR1R Raw Rose Corner 50 *

LR1E Raw Petroleum Corner 50 *

LR3W Raw 3D Scratch White Corner 50 *

LR3A Raw 3D Scratch Pearl Corner 50 *

LR3L Raw 3D Scratch Blue Corner 50 *

LR3E Raw 3D Scratch Petroleum Corner 50 *



1,4x1,4 cm - 5⁵/₈"x5⁵/₈"

A0RW Raw White Corner A.E. 1,4 *

A0RP Raw Pearl Corner A.E. 1,4 *

A0RS Raw Sand Corner A.E. 1,4 *

A0RB Raw Blue Corner A.E. 1,4 *

A0RR Raw Rose Corner A.E. 1,4 *

A0RC Raw Petroleum Corner A.E. 1,4 *

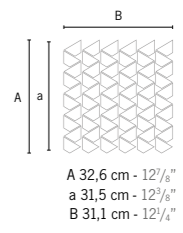

* THESE PARTS ARE SUPPLIED TO ORDER - I PEZZI SONO DISPONIBILI SU ORDINAZIONE

Les pièces sont disponibles sur commande | Die Teile sind auf Bestellung lieferbar | Las piezas se hacen por encargo | Изготавливаются на заказ



atlas concorde

* For the best performance of the mosaic we recommend the use of epoxy mortars (class RG - EN 13888/ISO 13007) or decorative resins-cement, following the manufacturer's instructions. / Al fine di ottenere una resa ottimale del mosaico, è consigliato l'utilizzo di malte epossidiche (classe RG - EN 13888/ISO 13007) o di resine cementizie attendendosi alle indicazioni di utilizzo fornite dal produttore. / Afin d'obtenir un rendu optimal de la mosaïque, nous vous conseillons d'utiliser des mortiers époxy (classe RG - EN 13888/ISO 13007) ou des résines à base de ciment, en suivant les indications d'utilisation fournies par le fabricant. / Um das Mosaik optimal zur Geltung zu bringen, empfehlen wir die Verwendung von Epoxidharzfugenmörtel (Klasse RG - EN 13888/ISO 13007) oder von vergüteten Fugenmörteln unter Beachtung der vom Hersteller angegebenen Verwendungshinweise. / Para obtener un rendimiento óptimo del mosaico, se aconseja utilizar mortero epoxi (clase RG - EN 13888/ISO 13007) o resinas de cemento siguiendo las indicaciones entregadas por el fabricante. / Для наилучшего эстетического результата при укладке мозаики рекомендуется использовать эпоксидные растворы (класс RG - EN 13888/ISO 13007) или полимерцемент, соблюдая инструкции производителя.

* For the best performance of the mosaic we recommend the use of epoxy mortars (class RG - EN 13888/ISO 13007) or decorative resins-cement, following the manufacturer's instructions. / Al fine di ottenere una resa ottimale del mosaico, è consigliato l'utilizzo di malte epossidiche (classe RG - EN 13888/ISO 13007) o di resine cementizie attendendosi alle indicazioni di utilizzo fornite dal produttore. / Afin d'obtenir un rendu optimal de la mosaïque, nous vous conseillons d'utiliser des mortiers époxy (classe RG - EN 13888/ISO 13007) ou des résines à base de ciment, en suivant les indications d'utilisation fournies par le fabricant. / Um das Mosaik optimal zur Geltung zu bringen, empfehlen wir die Verwendung von Epoxidharzfugenmörtel (Klasse RG - EN 13888/ISO 13007) oder von vergüteten Fugenmörteln unter Beachtung der vom Hersteller angegebenen Verwendungshinweise. / Para obtener un rendimiento óptimo del mosaico, se aconseja utilizar mortero epoxi (clase RG - EN 13888/ISO 13007) o resinas de cemento siguiendo las indicaciones entregadas por el fabricante. / Для наилучшего эстетического результата при укладке мозаики рекомендуется использовать эпоксидные растворы (класс RG - EN 13888/ISO 13007) или полимерцемент, соблюдая инструкции производителя.



Technical Specifications

- 550 **GREEN PROJECT**
- 551 **V-SHADE, COLOUR-SHADING**
- 552 **SIZES RANGE**
- 556 **PORCELAIN TILES TECHNICAL SPECIFICATIONS**
- 571 **UPEC CERTIFICATION**
- 572 **DESTINATIONS OF USE**
- 574 **PORCELAIN TILES FOR OUTDOORS**
- 576 **ANTI-SLIP CLASSIFICATION**
- 578 **WALL TILES TECHNICAL SPECIFICATIONS**
- 582 **LAYING SUGGESTIONS**
- 594 **GENERAL PACKING AND WEIGHT**
- 598 **GENERAL SALES CONDITIONS**

PORCELAIN AND WALL TILES: A SAFE CHOICE / LA CERAMICA: UNA SCELTA SICURA

Résistance et longévité / Widerstandsfähigkeit und lebensdauer / Resistencia y durabilidad / Стойкость и долговечность

Easy to maintain / Facile da manuteneere / Entretien facile / Leicht zu warten / Fácil de mantener / Простота ухода

Porcelain tiles do not require any special maintenance. / Il gres porcellanato non richiede manutenzioni particolari. / Le grès cérame n'exige aucun entretien particulier. / Feinsteinzeug erfordert keine besonderen Wartungsarbeiten. / El gres porcelánico no requiere particulares operaciones de mantenimiento. / Керамогранит не нуждается в особом уходе.

UV Resistant / Resistente ai raggi UV / Résistant aux rayons uv / UV-Strahlenfest / Resistente a los rayos UV / Стойкость к уф-излучению

Porcelain tiles maintain their colors even when exposed to continuous, direct sunlight or in contact with atmospheric agents or smog. / Il gres porcellanato rimane inalterato nei suoi colori anche se esposto alla luce diretta e continua del sole o a contatto con agenti atmosferici o smog. / Les coloris du grès cérame restent inaltérés même s'il est exposé à la lumière directe et continue du soleil ou au contact du smog et des agents atmosphériques. / Die Farben des Feinsteinzeugs bleiben unverändert erhalten, auch wenn es direktem und ständigem Sonnenlicht, der Witterung oder Smog ausgesetzt ist. / El gres porcelánico no se altera con el paso del tiempo, tampoco cambia su color cuando está expuesto a la luz directa y continua del sol o cuando entra en contacto con agentes climatológicos o contaminación. / Керамогранит не выцветает даже при постоянном воздействии солнечного света, атмосферных факторов, смога.

Scratch resistant / Résistant aux rayures / Kratzfestigkeit / Resistente a las rayas / Стойкость к царапинам

Porcelain tiles do not splinter, break or get damaged. / Il gres porcellanato non si scheggia, non si rompe e non si danneggia. / Le grès cérame ne subit ni ébréchures, ni cassures, ni dommages. / Feinsteinzeug splittert nicht, es zerbricht nicht und erleidet keine Beschädigungen. / El gres porcelánico no se desportilla, no se rompe y no se estropea. / Керамогранит не раскалывается, не ломается, не повреждается.

Easy to clean / Facile da pulire / Facile à nettoyer / Leicht zu reinigen / De fácil limpieza / Легкость чистки

Porcelain tiles are easy to clean. / Il gres porcellanato si pulisce facilmente. / Le grès cérame se nettoie facilement. / Feinsteinzeug kann leicht gereinigt werden. / El gres porcelánico se limpia fácilmente. / Керамогранит легко очищается.

Stain resistant / Resistente alle macchie / résistant aux taches / Fleckenfestigkeit / Resistente a las manchas / Стойкость к пятнам

Porcelain tiles are waterproof, no liquid can damage the surface. / Il gres porcellanato è impermeabile e nessun tipo di liquido può danneggiarne la superficie. / Le grès cérame est imperméable et aucun type de liquide ne peut endommager sa surface. / Feinsteinzeug ist wasserundurchlässig und Flüssigkeiten jeglicher Art können seine Oberfläche nicht beschädigen. / El gres porcelánico es impermeable y ningún tipo de liquido puede estropear la superficie. / Керамогранит непроницаем, и никакая жидкость не может повредить его поверхность.

Resistant to chemicals / Resistente agli agenti chimici / Résistant aux agents chimiques / Beständigkeit gegen chemikalien / Resistente a los agentes químicos / Стойкость к химическим веществам

Porcelain tiles do not stain and resist the most aggressive chemical agents. / Il gres porcellanato non si macchia e resiste agli agenti chimici più aggressivi. / Le grès cérame ne se tache pas et résiste aux agents chimiques les plus agressifs. / Feinsteinzeug ist fleckenfest und beständig gegen die aggressivsten Chemikalien. / El gres porcelánico no se mancha y es resistente a los agentes químicos más agresivos. / Даже самые агрессивные химикаты не повреждают керамогранит и не оставляют на нем пятен.

Resistant to acids / Resistente agli acidi / résistant aux acides / Beständigkeit gegen säuren / Resistente a los ácidos / Стойкость к кислотам

Porcelain tiles are resistant to acids found in food and cleaning products. / Il gres porcellanato resiste agli acidi di uso alimentare e domestico. / Le grès cérame résiste aux acides d'usage alimentaire et domestique. / Feinsteinzeug ist beständig gegen Säuren, die in Nahrungsmitteln oder im Haushalt verwendet werden. / El gres porcelánico es resistente a los ácidos de uso alimenticio y doméstico. / Керамогранит устойчив к кислотам, входящим в состав пищевых продуктов и средств бытовой химии.

Resistant to thermal shock / Resistente agli shock termici / résistant aux écarts thermiques / Beständigkeit gegen thermoschocks / Resistente a los choques térmicos / Стойкость к перепадам температур

A porcelain tile floor will not change as a result of sharp temperature fluctuations. / Un pavimento in gres porcellanato non si altera a causa di sbalzi termici. / Un sol en grès cérame ne subit aucune altération suite aux écarts thermiques. / Ein Feinsteinzeug-Fußboden wird von Temperaturschwankungen nicht beeinträchtigt. / El pavimento de gres porcelánico no cambia a causa de cambios bruscos de temperatura. / Напольные покрытия из керамогранита не разрушаются при перепадах температур.

Waterproof / Resistente all'acqua / Résistant à l'eau / Wasserfestigkeit / Resistente al agua / Стойкость к воде

Porcelain tiles are completely non-porous and therefore are not damaged by water or humidity. / Il gres porcellanato è completamente non poroso e non teme l'acqua e l'umidità. / Le grès cérame est absolument non poreux et ne craint ni l'eau ni l'humidité. / Feinsteinzeug ist absolut porös und fürchtet weder Wasser noch Feuchtigkeit. / El gres porcelánico no es poroso, no le penetra el agua y es resistente a la humedad. / Керамогранит – абсолютно непористый материал, поэтому не боится воды и влаги.

Frost resistant / Resistente al ghiaccio / Résistant au gel /Frostbeständigkeit / Resistente a las heladas / Стойкость к морозам

Porcelain tiles are frost resistant and therefore are not damaged by low temperatures. / Il gres porcellanato è ingelivo e resiste alle temperature più basse. / Le grès cérame est ingélif et résiste aux températures les plus basses. / Feinsteinzeug ist frostbeständig und widersteht den niedrigsten Temperaturen. / El gres porcelánico es resistente a las heladas y a las bajas temperaturas. / Керамогранит способен противостоять морозам и низким температурам.

Santé / Gesundheit / Salud / Здоровье

Zero allergens / Zero allergeni / Zéro allergène / Null allergene / Cero alérgenos / Ноль аллергенов

Porcelain tiles are inhospitable for mites, bacteria, fungi, molds, and other irritants. / Il gres porcellanato è inospitale per acari, batteri, funghi, muffe e altre sostanze irritanti. / Le grès cérame est inhospitalier vis-à-vis des acariens, bactéries, champignons, moisissures et autres substances irritantes. / Feinsteinzeug ist ungastlich für Milben, Bakterien, Pilze, Schimmel und andere Reizstoffe. / El gres porcelánico es inhóspito para los ácaros, bacterias, hongos, mohos y otras sustancias irritantes. / На поверхности керамогранита не накапливаются клещи, бактерии, грибки, плесень и другие болезнетворные микроорганизмы.

Zero VOCs / Zero VOC / Zéro cov / Null VOC / Cero VOC / Ноль летучих органических соединений

Porcelain tiles are intrinsically inorganic and do not emit volatile organic compounds (VOCs). / Le piastrelle in gres porcellanato sono intrinsecamente inorganiche e non emettono composti organici volatili. / Les carreaux en grès cérame sont intrinsèquement inorganiques et ne libèrent aucun composé organique volatil. / Feinsteinzeugfliesen sind von Natur aus anorganisch und setzen keine flüchtigen organischen Verbindungen frei. / Las baldosas de gres porcelánico son intrinsecamente inorgánicas y no emiten compuestos orgánicos volátiles. / Керамогранит является неорганическим материалом и не выделяет летучих органических соединений.

Zero formaldehyde / Zero formaldeide / Zéro formaldéhyde / Null formaldehyd / Cero formaldehído / Ноль формальдегида

Porcelain tiles do not contain formaldehyde. / Il gres porcellanato non contiene formaldeide. / Le grès cérame ne contient pas de formaldéhyde. / Feinsteinzeug ist formaldehydfrei. / El gres porcelánico non contiene formaldehído. / Керамогранит не содержит формальдегид.

Zero PVC / Zero PVC / Zéro pvc / Null PVC / Cero PVC / Ноль пвх

Porcelain tiles contain no PVC, plastics or petroleum derivatives. / Il gres porcellanato è privo di PVC, plastiche o derivati del petrolio. / Le grès cérame est privé de PVC, de matières plastiques et de dérivés du pétrole. / Feinsteinzeug ist frei von PVC, Kunststoffen oder Petroleumderivaten. / El gres porcelánico no contiene PVC, plástico o sustancias que derivan del petróleo. / Керамогранит не содержит ПВХ, пластиковых материалов, нефтепродуктов.

Prevent bacterial growth / Previene la crescita batterica / Il prévient la croissance bactérienne / Vorbeugung gegen das wachstum von bakterien / Previene la proliferación de bacterias / Предотвращение развития бактерий

Porcelain tiles are completely hygienic and inhospitable for bacteria, mites, molds, and fungi. / Il gres porcellanato è assolutamente Il igienico e inospitale per i batteri, acari, muffe e funghi. / Le grès cérame est absolument hygiénique et inhospitalier vis-à-vis des bactéries, acariens, moisissures et champignons. / Feinsteinzeug ist absolut hygienisch und ungastlich für Bakterien, Milben, Schimmel und Pilze. / El gres porcelánico es totalmente higiénico e inhóspito para las bacterias, ácaros, mohos y hongos. / Керамогранит абсолютно гигиеничен и препятствует развитию бактерий, клещей, плесени, грибка.

Sécurité / Sicherheit / Seguridad / Безопасность

Non-slip / Antiscivolo / Antiglisse / Rutschfestigkeit / Antideslizante / Препятствование скольжению

Porcelain tile surfaces can be made with an abrasive surface grit that can increase traction and reduce the risk of slipping. / Le superfici in gres porcellanato possono essere realizzate con una graniglia abrasiva superficiale in grado di aumentare la trazione e ridurre i rischi di scivolamento. / Les surfaces en grès cérame peuvent être réalisées avec un fond superficiel abrasif en mesure daugmenter la traction et réduire le risque de glissade. / Die Oberflächen des Feinsteinzeugs können mit die Reibung erhöhenden Splitten bereichert werden, welche die Trittsicherheit verbessern und die Gefahr von Austrutschern mindern. / Las superficies de gres porcelánico se fabrican con una granalla abrasiva superficial en grado de aumentar la tracción y reducir los riesgos de deslizamiento. / На поверхность керамогранитной плитки в процессе изготовления может наноситься специальная абразивная крошка, которая увеличивает сцепление и снижает риск скольжения.

Fire resistant / Resistente al fuoco / Résistant au feu / Feuerfestigkeit / Resistente al fuego / Огнестойкость

Porcelain tiles are not flammable, reduce the spread of flames, do not burn, and do not emit toxic fumes. / Le piastrelle in gres porcellanato non sono infiammabili, riducono la propagazione della fiamma, non bruciano e non emettono fumi tossici. / Les carreaux en grès cérame sont ininflammables, ils réduisent la propagation de la flamme, ne brûlent pas et de libèrent aucune fumée toxique. / Feinsteinzfliessen sind nicht entflammbar, sie mindern die Flammenausbreitung, brennen nicht und setzen keinen toxischen Rauch frei. / Las baldosas de gres porcelánico no son inflamables, reducen la propagación de las llamas, son resistentes al fuego y no emiten humos tóxicos. / Керамогранитная плитка не воспламеняется, ограничивает распространение огня, не горит, не выделяет токсичного дыма.

Heat resistant / Resistente al calore / Résistant à la chaleur / Wärmebeständigkeit / Resistente al calor / Термостойкость

Porcelain tiles do not change shape at high temperatures. / Il gres porcellanato non si altera alle alte temperature. / Le grès ne subit aucune altération aux températures élevées. / Feinsteinzeug wird von hohen Temperaturen nicht verändert. / El gres porcelánico no se altera con las altas temperaturas. / Керамогранит не повреждается под действием высоких температур.

Environnement / Umwelt / Ambiente / Окружающая среда

Energy efficiency / Efficienza energetica / Efficacité énergétique / Energieeffizienz / Eficiencia energética / Энергоэффективность

The high thermal inertia of porcelain tiles moderates the changes in temperature of the rooms, favoring energy savings. / L'elevata inerzia termica del gres porcellanato modera gli sbalzi di temperatura degli ambienti, favorendo il risparmio energetico. / La haute inertie thermique du grès cérame modère les écarts de température à l'intérieur des pièces, en favorisant ainsi les économies d'énergie. / Die hohe Wärmeträgheit des Feinsteinzeugs reduziert starke Temperaturschwankungen in den Räumen und ermöglicht demzufolge eine Energieeinsparung. / La elevada inercia térmica del gres porcelánico modera los cambios de temperatura de los ambientes, favoreciendo el ahorro energético. / Высокая тепловая инерция керамогранита сглаживает колебания температуры в помещениях, что позволяет значительно экономить энергию.

Ecological / Ecologico / Écologique / Ökologisch / Ecológico / Экологичность

Porcelain tiles have a low environmental impact at all stages of their production, from the raw materials to disposal and recycling. / Il gres porcellanato ha un basso impatto ambientale in tutte le fasi del suo processo industriale, dalle materie prime fino allo smaltimento e al riciclo. / Le grès cérame a un faible impact sur l'environnement durant toutes les phases de son processus industriel, à partir des matières premières jusqu'à l'élimination et au recyclage. / In allen Phasen seines Herstellungsprozesses verursacht das Feinsteinzeug eine geringfügige Umweltbelastung, angefangen beim Abbau der Rohstoffe bis zur Entsorgung und zum Recycling. / El gres porcelánico tiene un bajo impacto ambiental en todas las fases de su proceso industrial, dese las materias primas hasta la eliminación y el reciclaje. / Керамогранит имеет низкое воздействие на окружающую среду на всем протяжении жизненного цикла: от добычи сырья до переработки и утилизации.

Recycling and re-use / Riciclo e riutilizzo / Recyclage et réutilisation / Recykling und wiederverwertung / Reciclaje y reutilización / Переработка и утилизация

Porcelain tiles are made with recycled materials, last a long time, and can be re-used because they retain their original appearance. / Il gres porcellanato è realizzato con materiali di riciclo, dura a lungo e mantenendo l'aspetto originario può essere riciclato. / Le grès cérame est fabriqué avec des matériaux de recyclage, il dure longtemps en maintenant son aspect d'origine et il est recyclable. / Feinsteinzeug wird aus Recycling-Material hergestellt, hat eine lange Lebensdauer, erhält sein ursprüngliches Aussehen und kann recycelt werden. / El gres porcelánico está fabricado con materiales de reciclado, es duradero al paso del tiempo y se puede reciclar manteniendo el aspecto original. / Керамогранит изготавливается из переработанных материалов, долговечен, сохраняет во времени свои первоначальные характеристики и поддается переработке.

Ideal for floor heating systems / Ideale per sistemi di riscaldamento a pavimento / Idéal pour les systèmes de chauffage au sol / Ideal für fußbodenheizsysteme / Indicado para los sistemas de calefacción por suelo radiante / Идеальное решение для теплого пола

Porcelain tiles can be effectively combined with floor heating systems. / Il gres porcellanato può essere abbinato in modo efficace a sistemi di riscaldamento a pavimento. / Le grès cérame peut être associé de manière efficace à des systèmes de chauffage au sol. / Feinsteinzeug ist optimal leistungsfähig in Verbindung mit Fußbodenheizsystemen. / El gres porcelánico se puede utilizar eficazmente con sistemas de calefacción por suelo radiante. / Керамогранит отлично подходит для облицовки полов с подогревом.

WALL TILES ADDITIONAL BENEFITS / PROPRIETÀ CERAMICA DA RIVESTIMENTO / PROPRIETÉS DE LA CÉRAMIQUE POUR REVÊTEMENTS / EIGENSCHAFTEN DER WANDFLIESEN / CARACTERÍSTICAS Y BENEFICIOS DE LA CERÁMICA PARA REVESTIMIENTO / СВОЙСТВА КЕРАМИЧЕСКОЙ ПЛИТКИ

While porcelain tiles are ideal for use on the floor thanks to their hardness and extreme durability, the light weight and workability of white body tiles make them ideal for use on walls: cuts and holes can be made quickly and easily, reducing installation time and costs. / Mentre il gres porcellanato è ideale per l'uso a pavimento, per la sua durezza e l'estrema resistenza, le caratteristiche di leggerezza e lavorabilità del rivestimento in pasta bianca lo rendono ideale per l'uso a parete: i tagli e i fori saranno eseguiti facilmente e velocemente, riducendo i tempi e i costi di posa. / Tandis que le grès cérame est idéal pour l'usage au sol en raison de sa dureté et de son extrême résistance, les caractéristiques de légèreté et d'usinabilité des carreaux en pâte blanche en font l'idéal pour l'usage mural : les découpes et les perçages s'effectuent facilement et rapidement, en réduisant les temps et les coûts de la pose. / Während das Feinsteinzeug dank seiner Härte und extremen Widerstandsfähigkeit ideal für die Fußbodenverlegung ist, machen die Leichtigkeit und die Verarbeitungsfreundlichkeit der weißscherbigen Wandbeläge diese ideal für Wandverlegungen: Schnitte und Bohrungen werden leicht und schnell ausgeführt, wodurch die Verlegungszeiten und -kosten sich verringern. / Si bien el gres porcelánico es indicado para su uso en pavimentos, por su dureza y máxima resistencia, el revestimiento de pasta blanca es indicado para su uso en paredes por sus propiedades de ligereza y facilidad de trabajo: se consigue una mejor facilidad y rapidez de cortes y perforación, reduciendo los tiempos y costes de colocación. / Если керамогранит, в силу своей твердости и стойкости, особенно рекомендован для полов, то такие характеристики, как небольшой вес и высокая обрабатываемость, делают плитку из белой глины идеальной для монтажа на стену: легкость и быстрота резки и сверления снижают затраты времени и денег на укладку.

While porcelain tiles are ideal for use on the floor thanks to their hardness and extreme durability, the light weight and workability of white body tiles make them ideal for use on walls: cuts and holes can be made quickly and easily, reducing installation time and costs. / Mentre il gres porcellanato è ideale per l'uso a pavimento, per la sua durezza e l'estrema resistenza, le caratteristiche di leggerezza e lavorabilità del rivestimento in pasta bianca lo rendono ideale per l'uso a parete: i tagli e i fori saranno eseguiti facilmente e velocemente, riducendo i tempi e i costi di posa. / Tandis que le grès cérame est idéal pour l'usage au sol en raison de sa dureté et de son extrême résistance, les caractéristiques de légèreté et d'usinabilité des carreaux en pâte blanche en font l'idéal pour l'usage mural : les découpes et les perçages s'effectuent facilement et rapidement, en réduisant les temps et les coûts de la pose. / Während das Feinsteinzeug dank seiner Härte und extremen Widerstandsfähigkeit ideal für die Fußbodenverlegung ist, machen die Leichtigkeit und die Verarbeitungsfreundlichkeit der weißscherbigen Wandbeläge diese ideal für Wandverlegungen: Schnitte und Bohrungen werden leicht und schnell ausgeführt, wodurch die Verlegungszeiten und -kosten sich verringern. / Si bien el gres porcelánico es indicado para su uso en pavimentos, por su dureza y máxima resistencia, el revestimiento de pasta blanca es indicado para su uso en paredes por sus propiedades de ligereza y facilidad de trabajo: se consigue una mejor facilidad y rapidez de cortes y perforación, reduciendo los tiempos y costes de colocación. / Если керамогранит, в силу своей твердости и стойкости, особенно рекомендован для полов, то такие характеристики, как небольшой вес и высокая обрабатываемость, делают плитку из белой глины идеальной для монтажа на стену: легкость и быстрота резки и сверления снижают затраты времени и денег на укладку.

Ease of installation / Facilità di lavorazione / Facilité de travail / Verarbeitungsfreundlichkeit / Fácil de trabajar / Легкость обработки

Cuts, holes, and bevels are easily made and reduce the time it takes to lay the white body tiles. / Tagli, fori, bisellature sono facili da realizzare e rendono più veloce la posa dei rivestimenti in pasta bianca. / Les découpes, les perçages et les biseautages sont faciles à réaliser et rendent plus rapide la pose des carrelages en pâte blanche. / Schnitte, Bohrungen, Abkantungen sind leicht zu verwirklichen, daher können weißscherbige Keramikbeläge überall schneller verlegt werden. / Cortes, perforaciones y biselados se realizan fácilmente y la instalación de los revestimientos de pasta blanca se hace con rapidez. / Легкость резки, сверления, сквашивания граней ускоряет процесс укладки настенной плитки из белой глины.

Extremely easy to clean / Estrema facilità di pulizia / Nettoyage extrêmement facile / Extrem einfache Reinigung / Máxima facilidad de limpieza / Предельная простота ухода

White body ceramic tiles can be cleaned with a simple passage of hot water or neutral detergent. / I rivestimenti ceramici in pasta bianca si puliscono con un semplice passaggio di acqua calda o detergente neutro. / Les carrelages céramiques en pâte blanche se nettoient simplement avec de l'eau chaude ou avec un détergent neutre. / Die weißscherbigen Keramikbeläge werden einfach durch Abwischen mit warmem Wasser oder einem neutralen Putzmittel gereinigt. / Los revestimientos cerámicos de pasta blanca se limpian pasando un trapo húmedo con agua caliente o detergente neutro. / Настенная плитка из белой глины очищается теплой водой или нейтральным моющим средством.

Green Project

Sustainability / Sostenibilità

In the environmental and economic sciences, sustainability is defined as the condition of development capable of ensuring the satisfaction of the needs of the present generation without compromising the ability of future generations to realize their own. Several international certifications guarantee that the Atlas Concorde products meet the criteria of sustainable construction, attesting to their low impact on the ecosystem, compliance with declared standards and attention to comfort.

Nelle scienze ambientali ed economiche, la sostenibilità è definita come condizione di uno sviluppo in grado di assicurare il soddisfacimento dei bisogni della generazione presente senza compromettere la possibilità delle generazioni future di realizzare i propri. Diverse certificazioni internazionali garantiscono che i prodotti Atlas Concorde rispondono ai criteri del costruire sostenibile, attestandone il basso impatto sull'ecosistema, la conformità agli standard dichiarati e l'attenzione al comfort abitativo.

Certifications / Certificazioni



ISO 9001

In 1995 Atlas Concorde obtained ISO 9001 quality certification for its products. It is an international recognition referring to the company's entire quality system, from the receipt of raw materials to their transformation, from the distribution of the product to their placement on the market.

Sin dal 1995 Atlas Concorde ha ottenuto per i propri prodotti la certificazione di qualità ISO 9001. Si tratta di un riconoscimento internazionale riferito all'intero sistema di qualità aziendale, dall'ingresso delle materie prime alla loro trasformazione, dalla distribuzione del prodotto alla sua immissione sul mercato.



LEED V4

All Atlas Concorde porcelain floor and white body wall tiles can be used in projects that follow the guidelines of the GREEN BUILDING COUNCIL, which promotes the independent certification system LEED BD&C v4 (Leadership in Energy and Environmental Design, Building Design & Construction), whose parameters establish precise criteria for the design and construction of buildings that are healthy, energy efficient and with low environmental impact. All our products in porcelain stoneware and in white clay can therefore contribute to obtaining the LEED V4 rating of buildings, in relation to different areas: Sustainable Sites, Materials and Resources, Internal Environmental Quality.

Tutti i prodotti in gres porcellanato e in pasta bianca Atlas Concorde possono essere utilizzati in progetti che seguono le linee guida del GREEN BUILDING COUNCIL, che promuove il sistema di certificazione indipendente LEED BD&C v4 (Leadership in Energy and Environmental Design, Building Design & Construction), i cui parametri stabiliscono precisi criteri di progettazione e realizzazione di edifici salubri, energeticamente efficienti e a impatto ambientale contenuto. Tutti i nostri prodotti in gres porcellanato e in pasta bianca possono quindi contribuire all'ottenimento del rating LEED V4 degli edifici, relativamente a diverse aree tematiche: Siti Sostenibili, Materiali e Risorse, Qualità ambientale Interna.



EPD

Atlas Concorde also has an EPD declaration, which attests to the environmental sustainability of its products. The EPD (Environmental Product Declaration) also assesses the life cycle of a product, from extraction to production, transport, installation, maintenance, and cleaning. Atlas Concorde's EPD declaration was certified by the independent certifying body EPD ITALY.

Atlas Concorde dispone inoltre di una dichiarazione EPD, che attesta la sostenibilità ambientale dei prodotti. Anche la EPD (Environmental Product Declaration) valuta il ciclo di vita di un prodotto, dall'estrazione all'utilizzo passando per la produzione, il trasporto, l'installazione, la manutenzione e la pulizia. La dichiarazione EPD di Atlas Concorde è stata certificata dall'ente di certificazione indipendente EPD ITALY.



PEF

The environmental footprint of products (PEF, Product Environmental Footprint, according to Recommendation 2013/179/EU) is a measurement that, based on various criteria, indicates the environmental performance of a product or service over its lifetime, taking into account supply chain activities: from the extraction of raw materials, to the production, use, and end of life of the product. Atlas Concorde has a verified PEF. Atlas Concorde's PEF was verified by the DNV-GL certifying body.

L'impronta ambientale dei prodotti (PEF, Product Environmental Footprint, secondo la Raccomandazione 2013/179/UE) è una misura che, sulla base di vari criteri, indica le prestazioni ambientali di un prodotto o servizio nel corso del proprio ciclo di vita, tenendo conto delle attività della catena di approvvigionamento: dall'estrazione di materie prime, alla produzione, all'uso e fine vita del prodotto. Atlas Concorde dispone di una PEF verificata. La PEF di Atlas Concorde è verificata dall'organismo di certificazione DNV-GL.



FDES

Atlas Concorde has also drafted an FDES environmental declaration (Fiche de déclaration environnementale et sanitaire), this also having the purpose of transparently disclosing the product's impact, covering each phase from product extraction to production and finally laying and use.

Atlas Concorde ha realizzato inoltre la dichiarazione ambientale FDES (Fiche de déclaration environnementale et sanitaire), anch'essa con lo scopo di rendicontare in modo trasparente l'impatto del prodotto, a partire dalla fase di estrazione del prodotto, passando dalla fase di produzione, fino alla posa ed all'utilizzo.



HPD

Atlas Concorde has a HPD (Health Product Declaration) declaration, a complete report on the health characteristics of the finished product, compiled according to the HPD standard.

Atlas Concorde dispone della dichiarazione HPD (Health Product Declaration), un report completo sulle caratteristiche di salubrità del prodotto finito, compilato secondo lo standard HPD.



CAM/ISO 14021

An environmental declaration according to the ISO 14021 international standard, observance of Minimum Environmental Criteria, and the adoption of sustainability policies demonstrate Atlas Concorde's attention to environmental issues and allow the inclusion of its products in Green Public Tenders.

La dichiarazione ambientale secondo lo standard internazionale ISO 14021 ed il rispetto dei requisiti dei Criteri Ambientali Minimi permette ad Atlas Concorde, grazie all'adozione di politiche di sostenibilità, di dimostrare l'attenzione alle problematiche ambientali e proporre l'inserimento dei propri prodotti negli Appalti Pubblici Verdi.

For further details, please refer to / Per ulteriori dettagli, fare riferimento a: atlasconcorde.com

V-SHADE, colour-shading / Stonalizzazione V-SHADE

The V-Shade classification indicates the colour shading level of a product, that is to say the chromatic and/or surface variation among tiles of the same collection. A strong colour shading is typical of ceramic collections that reproduce natural stones and marble. A moderate colour shading is typical of ceramic collections for which a homogeneous chromatic surface is an aesthetic feature of contemporary design.

La classificazione VShade indique le niveau de gradation du produit, c'est-à-dire de variation chromatique et/ou superficielle entre des dalles d'une même collection. Une forte variation est conseillée lorsque l'on utilise une collection qui rappelle des matériaux naturels comme la pierre et le marbre. Des variations de tons plus modérées caractérisent des collections où l'homogénéité chromatique superficielle est une qualité esthétique ou véritable indice de design contemporain.

La clasificación V-Shade indica el nivel de variación de tono del producto, o de variación cromática y/o superficial que existe entre las baldosas de una misma colección. Una variación de tono significativa es indicada en las colecciones que evocan materiales naturales como la piedra y el mármol. Variaciones de tono más moderadas caracterizan colecciones en que la homogeneidad cromática superficial es un valor estético índice de un diseño contemporáneo.



V1

Uniform appearance

Aspetto uniforme

Aspect uniforme
Gleichmäßiges Erscheinungsbild
Aspecto uniforme
Однородный вид



V2

Slight variation

Variatione minima

Variation minimale
Leichte Abweichung
Variación mínima
Минимальная Неоднородность



V3

Moderate variation

Variatione moderata

Variation Modérée
Mäßige Abweichung
Variación moderada
Умеренная Неоднородность



V4

Substantial variation

Variatione sostanziale

Variation substantielle
Grundlegende Abweichung
Variación sustancial
Значительная Неоднородность

Serie / Series Série / Serie Serie / Серия	Colore / Colour Couleur / Farbe Color / Цвет	Stonalizzazione / Colour-shading Denuancement / Marmorierung Contraste / Цветовое отличие
AIX	Porcelain & Wall tiles	V3 Porcelain tiles V2 Wall tiles
ARBOR	Porcelain & Wall tiles	V3 Porcelain tiles V2 Wall tiles
ARKSHADE	Porcelain & Wall tiles	V1
ARTY	Wall tiles	V1
AXI	White Pine	V2
	Silver Fir	V2
	Grey Timber	V2
	Dark Oak	V2
	Golden Oak	V3
	Brown Chestnut	V3
BLAZE	Porcelain & Wall tiles	V3
BOOST	Porcelain & Wall tiles	V3 Porcelain tiles V2 Wall tiles
BRAVE	Porcelain & Wall tiles	V2
BRICK	Calacatta Extra	V3
	Statuario Select	V3
	Carrara	V2
	Silver Dream	V2
	Noir St. Laurent	V2
	Persian Jade	V3
	Royal Gold	V3
	White Bevel	V1
	Silver Bevel	V1
	Black Bevel	V1
DOLMEN PRO	Cenere	V2
	Grigio	V2
	Rosso	V2
	Mix	V4
DWELL	Porcelain & Wall tiles	V2
ECHO	Porcelain tiles	V2
ETIC	Ebano	V2
	Noce	V3
	Palissandro	V3
	Rovere	V3
	Rovere Bianco	V2
	Rovere Grigio	V3
	Ulivo	V3
ETIC PRO	Porcelain tiles	V3
EVOLVE	Porcelain tiles	V2
EWALL	Wall tiles	V2
EXENCE	Porcelain tiles	V2

<https://www.atlasconcorde.com/en/ceramic-glossary/v/>

Denuancement, V-SHADE / V-SHADE, Marmorierung / Contraste, V-SHADE / Цветовое отличие, V-SHADE

La classificazione VShade indica il livello di stonalizzazione del prodotto, ovvero di variazione cromatica e/o superficiale che intercorre tra le piastrelle di una stessa collezione. Una forte stonalizzazione è indicata nelle collezioni che richiamano materiali naturali come la pietra e il marmo. Stonalizzazioni più moderate caratterizzano collezioni in cui l'omogeneità cromatica superficiale è un valore estetico indice di un design contemporaneo.

Die Klassifizierung V-Shade gibt das Niveau des Farbverlaufs des Produktes oder die Abweichung des Farbtons und/oder Oberfläche unter den Fliesen der gleichen Kollektion an. Starke Farbunterschiede zeigen sich vor allem in Kollektionen, die natürliche Materialien wie Stein und Marmor nachempfunden. Weniger starke Farbunterschiede kennzeichnen Kollektionen deren Farbhomogenität der Oberflächen ein ästhetischer Wert des zeitgenössischen Designs darstellen.

Классификация V-Shade указывает на уровень цветовой или фактурной неоднородности плиток, т.е. на различия по цвету или по фактуре между плитками одной коллекции. Высокая цветовая неоднородность присутствует на плитках, имитирующих природные материалы, например, камень или мрамор. Умеренная неоднородность цвета наблюдается на плитках, предназначенных для оформления интерьеров или экстерьеров в современном стиле.

Serie / Series Série / Serie Serie / Серия	Colore / Colour Couleur / Farbe Color / Цвет	Stonalizzazione / Colour-shading Denuancement / Marmorierung Contraste / Цветовое отличие
GREENCOLORS	Porcelain tiles	V1
HEARTWOOD	Porcelain tiles	V3
KLIF	Porcelain & Wall tiles	V3 Porcelain tiles V2 Wall tiles
KONE	Porcelain & Wall tiles	V2
MARK	Porcelain tiles	V3 Porcelain tiles
MARVEL	Porcelain & Wall tiles	V2
MARVEL DREAM	Brazil Green	V3
	Ultramarine	V3
	Crystal Beauty	V2
	Bianco Fantastico	V2
	Morning Sky	V3
MARVEL EDGE	Grigio Intenso	V2
	Black Atlantis	V2
	Royal Calacatta	V3
	Imperial White	V2
	Elegant Sable	V2
	Gris Supreme	V2
	Absolute Brown	V3
	Gold Onyx	V3
	Agata Azul	V3
	Red Luxury	V3
MARVEL GEMS	Porcelain tiles	V2
MARVEL PRO	Statuario Select	V3
	Grey Fleury	V3
	Noir St. Laurent	V2
	Cremo Delicato	V2
	Travertino Alabastrino	V2
	Travertino Silver	V2
MARVEL STONE	Porcelain & Wall tiles	V2
MEK	Porcelain & Wall tiles	V2
NASH	Porcelain tiles	V3
NID	Porcelain & Wall tiles	V2
RAW	Porcelain & Wall tiles	V3
ROOM	Porcelain tiles	V1
SEASTONE	Porcelain tiles	V2
SUNROCK	Porcelain tiles	V3
TRUST	Porcelain tiles	V3 Porcelain tiles



atlas concorde

Porcelain Tiles

Complies with	EN 14411 (ISO 13006)	Appendix	G	Group	Bla
Conforme alla norma	EN 14411 (ISO 13006)	Appendice	G	Gruppo	Bla
Conforme à la norme	EN 14411 (ISO 13006)	Appendice	G	Groupe	Bla
Entsprechend	EN 14411 (ISO 13006)	Anhang	G	Gruppe	Bla
Conforme a la norma	EN 14411 (ISO 13006)	Apéndice	G	Grupo	Bla
Соответствует норме	EN 14411 (ISO 13006)	Приложение	G	Группа	Bla

- (*) The permissible deviation, in % or mm, of the average size for each tile (2 or 4 sides) from work size (WS).
Deviazione ammissibile, in % oppure mm, della dimensione media di ogni piastrella (2 oppure 4 lati) dalla dimensione di fabbricazione (WS).
- (**) The permissible deviation, in % or mm, of the average thickness for each tile from the work size thickness (WS).
Deviazione ammissibile, in % oppure mm, dello spessore medio di ogni piastrella dallo spessore riportato nella dimensione di fabbricazione (WS).
- (***) The maximum permissible deviation from straightness, in % or mm, related to the corresponding work sizes (WS).
Deviazione massima ammissibile di rettilineità, in % oppure mm, in rapporto alle dimensioni di fabbricazione (WS) corrispondenti.
- (****) The maximum permissible deviation from rectangularity, in % or mm, related to the corresponding work sizes (WS).
Deviazione massima ammissibile di ortogonalità, in % oppure mm, in rapporto alle dimensioni di fabbricazione (WS) corrispondenti.
- c.c. The maximum permissible deviation from centre curvature, in % or mm, related to diagonal calculated from the work sizes (WS).
Deviazione massima ammissibile della curvatura del centro, in % oppure mm, in rapporto alla diagonale calcolata secondo le dimensioni di fabbricazione (WS).
- e.c. The maximum permissible deviation from edge curvature, in % or mm, related to the corresponding work sizes (WS).
Deviazione massima ammissibile della curvatura dello spigolo, in % oppure mm, in rapporto alle dimensioni di fabbricazione (WS) corrispondenti.
- w. The maximum permissible deviation from warpage, in % or mm, related to diagonal calculated from the work sizes (WS).
Deviazione massima ammissibile dello sverglamento, in % oppure mm, in rapporto alla diagonale calcolata secondo le dimensioni di fabbricazione (WS).
- (1) Determination of slip resistance of pedestrian surfaces; it does not cover sports surfaces and road surfaces for vehicles (skid resistance).
Determinazione della resistenza allo scivolamento delle superfici pedonabili; non si applica alle pavimentazioni sportive ed alle pavimentazioni stradali veicolari.
- (2) Anti-slip performance is guaranteed at the time of delivery of the product.
Le prestazioni anti-slip vengono garantite al momento della consegna del prodotto.
- (3) However, tiles with a DCOF of 0.42 or greater are not necessarily suitable for all projects. The specifier shall determine tiles appropriate for specific project conditions, considering by way of example, but not in limitation, type of use, traffic, expected contaminants, expected maintenance, expected wear, and manufacturers' guidelines and recommendations.
- (4) For further details, please refer to outdoor design general catalogue. Per maggiori informazioni riferirsi al catalogo generale Outdoor Design.
- (5) Only for products with 20 mm thickness. Solo per prodotti a 20mm di spessore.

Technical specification symbols / Simbologia caratteristiche tecniche

Regularity characteristics Caratteristiche di regolarità Caractéristiques de régularité Regelmäßigkeit Características de regularidad Свойства правильности	ISO 10545-2		Length and width Lunghezza e larghezza / Longuer et largeur / Länge und breite / Longitud y anchura / Размеры сторон (*)	
			Thickness Spessore / Epaisseur / Stärke / Grosor / Толщина (**)	
			Straightness of sides Rettilineità degli spigoli Rectitude des aretes / Kantengeradheit / Rectilineidad de las aristas / Кривизна сторон (***)	
Structural characteristics Caratteristiche strutturali Caractéristiques structurales Strukturelle Eigenschaften Características estructurales Конструктивные свойства	ISO 10545-3		Water absorption (in % by mass) Massa d'acqua assorbita (come % della massa) Masse d'eau absorbée (en % de la masse) / Aufgenommene Wassermasse (in % der Masse) / Peso de agua absorbida (como % de la masa) / Водопоглощение (% от массы)	
	ASTM C373-18			
Bulk mechanical characteristics Caratt. meccaniche massive Caractéristiques mécaniques massives Mechanische Eigenschaften des Scherben Características mecánicas Механические свойства массы	ISO 10545-4		Breaking strength Sforzo di rottura Force de rupture / Bruchlast / Esfuerzo de ruptura / Усилие на излом	
	EN 1339 Annex F			Modulus of rupture Resistenza alla flessione Résistance à la flexion / Biegefestigkeit / Resistencia a la flexión / Устойчивость к изгибу
	ISO 10545-5			Bending strength and breaking load Resistenza a flessione e al carico di rottura Résistance à la flexion et à la charge de rupture / Biege- und Bruchfestigkeit Extraordinaria resistencia a la flexión y a la carga de rotura / Предел прочности при изгибе и разрушающая нагрузка (4)(5)
Surface mechanical characteristics Caratt. meccaniche superficiali Caractéristiques mécaniques superficielles Mechanische Eigenschaften der Oberfläche Características mecánicas superficiales Поверхностные механические свойства	EN 101 ⁽¹⁾		MOHS hardness Durezza MOHS Dureté Mohs / Ritzhärte nach Mohs / Dureza Mohs / Твёрдость по Моосу	
	ISO 10545-6			Resistance to deep abrasion of unglazed tiles (removed volume) Resistenza all'abrasione profonda delle piastrelle non smaltate (volume materiale asportato) Résistance à l'abrasion profonde des carreaux non émaillés (volume du matériau retiré) Widerstand gegen Tiefenverschleiß von unglasierten Fliesen (Materialabtrag bzw. Volumenverlust) Resistencia a la abrasión profunda de las baldosas no esmaltadas (volumen material extraído) Стойкость к глубокому истиранию неглазурованных плиток (объем удаленного материала)
	ISO 10545-8			Coefficient of thermal linear EXPANSION Coefficiente di DILATAZIONE TERMICA lineare Coefficient de dilatation thermique linéique / Lineare thermische Dehnung Coeficiente de dilatación térmica lineal / Коэффициент линейного расширения
Thermal and hygrometric characteristics Caratt. termo-igrometriche C. thermiques et hygrométriques Thermo-hygrometrische Eigenschaften Características termohigrométricas Тепловые и гигрометрические свойства	ISO 10545-9		THERMAL SHOCK resistance Resistenza agli SBALZI TERMICI Résistance aux écarts de température / Temperaturwechs elbeständigkeit Resistencia a los cambios de temperatura / Устойчивость к перепаду температур	
	ISO 10545-10			Moisture expansion (in mm/m) Dilatazione all'umidità (in mm/m) Dilatation à l'humidité (en mm/m) / Feuchtigkeitsausdehnung (in mm/m) Dilatación por la humedad (en mm/m) / Расширение под воздействием влаги (в мм/м)
	ISO 10545-12			FROST resistance Resistenza al GELO Résistance aux gel / Frostbeständigkeit / Resistencia a las heladas / Морозоустойчивость
Physical properties Proprietà fisiche Propriétés physiques Physikalische Eigenschaften Propiedades físicas Физические характеристики	EN 1348		Bond strength/adhesion for improved cementitious adhesives Adesione a trazione con adesivi cementizi migliorati Adhérence par traction avec des ciments-colle améliorés / Scherfestigkeit mit verbesserten zementhaltigen Klebern Adherencia a tracción con adhesivos cementosos mejorados Прочность на растяжение при приклеивании улучшенными цементными клеями	
	-			Reaction to fire Reazione al fuoco Réaction au feu / Brandverhalten / Reacción al fuego / Огнестойкость
Chemical characteristics Caratteristiche chimiche Caractéristiques chimiques Chemische Eigenschaften Características químicas Химические свойства	ISO 10545-13		Resistance to household chemicals and swimming pool salts Resistenza ai prodotti chimici di uso domestico ed agli additivi per piscina Résistance aux produits chimiques à usage domestique et aux adjuvants pour piscine Beständigkeit gegen Haushaltschemikalien und Badewasserzusätze Resistencia a los productos químicos de uso doméstico / Стойкость к химикатам, используемым в быту и для бассейнов	
				Resistance to low concentrations of ACIDS and ALKALIS Resistenza a basse concentrazioni di ACIDI e ALCALI Résistance aux acides et aux alcalis à basse concentration / Beständigkeit gegen niedrigkonzentrierte Säuren und Laugen Resistencia a los ácidos y bases de baja concentración / Сопротивление кислотам и щелочам низкой концентрации
				Resistance to high concentrations of ACIDS and ALKALIS Resistenza ad alte concentrazioni di ACIDI e ALCALI Résistance aux acides et aux alcalis à haute concentration / Beständigkeit gegen hochkonzentrierte Säuren und Laugen Resistencia a los ácidos y bases de alta concentración / Сопротивление кислотам и щелочам низкой концентрации
Safety characteristics Caratteristiche di sicurezza Caractéristiques de sécurité Sicherheitsmerkmale Características de seguridad Характеристики безопасности	ISO 10545-14		Resistance to STAINING, for unglazed tiles Resistenza alle MACCHIE per piastrelle non smaltate Résistance aux taches pour carreaux non émaillés / Widerstand gegen Fleckenbildung für unglasierte Fliesen / Resistencia a las manchas para azulejos no esmaltados / Устойчивость к загрязнению, для неглазурованных плиток	
	DIN 51130			Shod Ramp Test Metodo della rampa "calzato" / Test de la rampe « chaussé » / Rampenmethode mit Schuhen Método de la rampa "calzado" / Метод наклонной плоскости (в обуви)
	DIN 51097			Barefoot Ramp Test Metodo della rampa a piedi nudi / Test de la rampe à pieds nus / Rampenmethode barfuß Método de la rampa a pies descalzos / Метод наклонной плоскости (босыми ногами) (1)(2)
	BS 7976			
	AS 4586			Pendulum Friction Test Metodo del Pendolo Méthode du Pendule / Pendelmethode / Método del péndulo / Метод маятника (1)(2)
	UNE-ENV 12633			
B.C.R.A. Rep. CEC/81			Coefficient of friction (COF) Coefficiente di attrito Coefficient de frottement / Reibungskoeffizient / Coeficiente de roce / Коэффициент трения (1)(2)	
ANSI A137.1			Dynamic coefficient of friction (DCOF) Coefficiente di attrito dinamico Coefficient de frottement dynamique / Dynamischer Reibungskoeffizient / Coeficiente de roce dinámico (1)(2)(3) Динамический коэффициент трения	

			Requirements for nominal size N Requisiti per dimensione nominale N			AIX				ARBOR		
			7 cm ≤ N < 15 cm		N ≥ 15 cm		Matte	Grip	Textured	Outdoor ✚ 20mm	Matte 7,5x60	
			(mm)	(%)	(mm)	(%)						
Regularity characteristics		Length and width Lunghezza e larghezza	± 0,9 (*) Non-rect. ± 0,4 (*) Rect.	± 0,6 (*) Non-rect. ± 0,3 (*) Rect.	± 2,0 (*) Non-rect. ± 1,0 (*) Rect.	Suitable for Conforme	Suitable for Conforme	Suitable for Conforme	Suitable for Conforme	Suitable for Conforme		
			Thickness Spessore	± 0,5 (**)	± 0,5 (**)	± 0,5 (**)	Suitable for Conforme	Suitable for Conforme	Suitable for Conforme	Suitable for Conforme	Suitable for Conforme	
			Straightness of sides Rettilinearità degli spigoli	± 0,8 (***) Non-rect. ± 0,4 (***) Rect.	± 0,5 (***) Non-rect. ± 0,3 (***) Rect.	± 1,5 (***) Non-rect. ± 0,8 (***) Rect.	Suitable for Conforme	Suitable for Conforme	Suitable for Conforme	Suitable for Conforme	Suitable for Conforme	
			Rectangularity (Measurement only on short edges when L/l ≥ 3) Ortogonalità (Misurazione da condurre solo sui lati corti quando L/l ≥ 3)	± 0,8 (****) Non-rect. ± 0,4 (****) Rect.	± 0,5 (****) Non-rect. ± 0,3 (****) Rect.	± 2,0 (****) Non-rect. ± 1,5 (****) Rect.	Suitable for Conforme	Suitable for Conforme	Suitable for Conforme	Suitable for Conforme	Suitable for Conforme	
Structural characteristics		Surface flatness Planarità	c.c. ± 0,8 Non-rect. c.c. ± 0,6 Rect.	c.c. ± 0,5 Non-rect. c.c. ± 0,4 Rect.	c.c. ± 2,0 Non-rect. c.c. ± 1,8 Rect.	Suitable for Conforme	Suitable for Conforme	Not applicable to "strong" structures Non applicabile a strutturati forti	Suitable for Conforme			
			e.c. ± 0,8 Non-rect. e.c. ± 0,6 Rect.	e.c. ± 0,5 Non-rect. e.c. ± 0,4 Rect.	e.c. ± 2,0 Non-rect. e.c. ± 1,8 Rect.							
			w. ± 0,8 Non-rect. w. ± 0,6 Rect.	w. ± 0,5 Non-rect. w. ± 0,4 Rect.	w. ± 2,0 Non-rect. w. ± 1,8 Rect.							
Structural characteristics		Water absorption (in % by mass) Massa d'acqua assorbita (come % della massa)	ISO 10545-3	E _s ≤ 0,5% Individual max 0,6% E _s ≤ 0,5% Valore max singolo 0,6%			≤ 0,1 %	≤ 0,1 %	≤ 0,1 %	≤ 0,1 %	≤ 0,1 %	
			ASTM C373-18	Requirement ANSI A137.1 Water Absorption Max ≤ 0,5%			≤ 0,5 %	≤ 0,5 %	≤ 0,5 %	≤ 0,5 %	≤ 0,5 %	
Bulk mechanical characteristics		Breaking strength Storzo di rottura	ISO 10545-4	S ≥ 700N (for thickness < 7,5 mm - per spessore < 7,5 mm) S ≥ 1300N (for thickness ≥ 7,5 mm - per spessore ≥ 7,5 mm)			S ≥ 1500 N	S ≥ 1500 N	S ≥ 1500 N	S ≥ 10000 N	S ≥ 1300 N	
				Modulus of rupture Resistenza alla flessione	R ≥ 35 N/mm ²			R ≥ 40 N/mm ²	R ≥ 40 N/mm ²	R ≥ 40 N/mm ²	R ≥ 45 N/mm ²	R ≥ 40 N/mm ²
					Bending strength and breaking load Resistenza a flessione e al carico di rottura (4)(5)	EN 1339 Annex F	-			-	-	-
Surface mechanical characteristics		Impact resistance, as coefficient of restitution Resistenza all'impatto, espresso come coefficiente di restituzione	ISO 10545-5	Declared value Valore dichiarato			≥ 0,55	≥ 0,55	≥ 0,55	≥ 0,55	≥ 0,55	
			EN 101	-			6	8	8	8	6	
Surface mechanical characteristics		Resistance to deep abrasion of unglazed tiles (removed volume) Resistenza all'abrasione profonda delle piastrelle non smaltate (volume materiale asportato)	ISO 10545-6	≤ 175 mm ³			≤ 150 mm ³	≤ 150 mm ³	≤ 150 mm ³	≤ 150 mm ³	≤ 150 mm ³	
			ISO 10545-8	Declared value Valore dichiarato			≤ 7 MK ⁻¹	≤ 7 MK ⁻¹	≤ 7 MK ⁻¹	≤ 7 MK ⁻¹	≤ 7 MK ⁻¹	
Thermal and hygrometric characteristics		Coefficient of thermal linear expansion Coefficiente di dilatazione termica lineare	ISO 10545-8	Declared value Valore dichiarato			≤ 7 MK ⁻¹	≤ 7 MK ⁻¹	≤ 7 MK ⁻¹	≤ 7 MK ⁻¹	≤ 7 MK ⁻¹	
			ISO 10545-9	Pass according to EN ISO 10545-1 Test superato in accordo con ISO 10545-1			Resistant Resiste	Resistant Resiste	Resistant Resiste	Resistant Resiste	Resistant Resiste	
			ISO 10545-10	Declared value Valore dichiarato			≤ 0,01% (0,1mm/m)	≤ 0,01% (0,1mm/m)	≤ 0,01% (0,1mm/m)	≤ 0,01% (0,1mm/m)	≤ 0,01% (0,1mm/m)	
			ISO 10545-12	Pass according to EN ISO 10545-1 Test superato in accordo con ISO 10545-1			Resistant Resiste	Resistant Resiste	Resistant Resiste	Resistant Resiste	Resistant Resiste	
Physical properties		Bond strength/adhesion for improved cementitious adhesives Adesione a trazione con adesivi cementizi migliorati	EN 1348	Declared value Valore dichiarato			≥ 1,0 N/ mm ² (Class C2 - EN 12004)	≥ 1,0 N/ mm ² (Class C2 - EN 12004)	≥ 1,0 N/ mm ² (Class C2 - EN 12004)	≥ 1,0 N/mm ² (Class C2 - EN 12004)	≥ 1,0 N/ mm ² (Class C2 - EN 12004)	
			-	Class A1 or A1 _{fl} Classe A1 oppure A1 _{fl}			A1 - A1 _{fl}	A1 - A1 _{fl}	A1 - A1 _{fl}	A1 - A1 _{fl}	A1 - A1 _{fl}	
Chemical characteristics		Resistance to household chemicals and swimming pool salts Resistenza ai prodotti chimici di uso domestico ed agli additivi per piscina	ISO 10545-13	Minimum Class B Classe minima B			A	A	A	A	A	
				Declared Class Classe dichiarata			LA	LA	LA	LA	LA	
				Declared Class Classe dichiarata			HA	HA	HA	HA	HA	
		Resistance to staining, for unglazed tiles Resistenza alle macchie per piastrelle non smaltate	ISO 10545-14	Declared Class Classe dichiarata			5	5	5	5	5	
Safety characteristics (1)(2)		Shod Ramp Test Metodo della rampa "calzato"	DIN 51130	Declared value Valore dichiarato			R10	R11	R11	R11	R10	
			DIN 51097	Declared value Valore dichiarato			A+B	A+B+C	A+B+C	A+B+C	A	
			BS 7976	PTV ≥ 36 classifies the surface as "low slip risk"			≥ 36 Dry ≥ 36 Wet	≥ 36 Dry ≥ 36 Wet	≥ 36 Dry ≥ 36 Wet	≥ 36 Dry ≥ 36 Wet	(●)	
			AS 4586	Declared Classification of the new pedestrian surface materials according to the Pendulum Test			Class P3	Class P4	Class P4	Class P4	(●●)	
			UNE-ENV 12633	Declared value Valore dichiarato			Class C2	Class C3	Class C3	Class C3	(●●●)	
			B.C.R.A. Rep. CEC/81	D. M. 236/89 del 14/06/89 μ > 0,40 per elemento scivolante cuoio su pavimentazione asciutta μ > 0,40 per elemento scivolante gomma dura su pavimentazione bagnata			> 0,40 Asciutto > 0,40 Bagnato	> 0,40 Asciutto > 0,40 Bagnato	> 0,40 Asciutto > 0,40 Bagnato	> 0,40 Asciutto > 0,40 Bagnato	> 0,40 Asciutto > 0,40 Bagnato	
ANSI A137.1	ANSI A.137.1-2017 Requires a minimum value of 0.42 for level interior space expected to be walked upon when wet. (3)			> 0,42 Wet	> 0,42 Wet	> 0,42 Wet	> 0,42 Wet	> 0,42 Wet				

ARBOR			ARKSHADE			AXI			BLAZE				BOOST			
Matte 30x240	Matte	Grip	Matte	Polished	Grip	Matte	Textured	Outdoor ✚ 20mm	Matte	Matte ✚ 6mm	Polished	Grip	Outdoor ✚ 20mm	Matte	Matte ✚ 6mm	Grip
Suitable for Conforme	Suitable for Conforme	Suitable for Conforme	Suitable for Conforme	Suitable for Conforme	Suitable for Conforme	Suitable for Conforme	Suitable for Conforme	Suitable for Conforme	Suitable for Conforme	Suitable for Conforme	Suitable for Conforme	Suitable for Conforme	Suitable for Conforme	Suitable for Conforme	Suitable for Conforme	Suitable for Conforme
Suitable for Conforme	Suitable for Conforme	Suitable for Conforme	Suitable for Conforme	Suitable for Conforme	Suitable for Conforme	Suitable for Conforme	Suitable for Conforme	Suitable for Conforme	Suitable for Conforme	Suitable for Conforme	Suitable for Conforme	Suitable for Conforme	Suitable for Conforme	Suitable for Conforme	Suitable for Conforme	Suitable for Conforme
Suitable for Conforme	Suitable for Conforme	Suitable for Conforme	Suitable for Conforme	Suitable for Conforme	Suitable for Conforme	Suitable for Conforme	Suitable for Conforme	Suitable for Conforme	Suitable for Conforme	Suitable for Conforme	Suitable for Conforme	Suitable for Conforme	Suitable for Conforme	Suitable for Conforme	Suitable for Conforme	Suitable for Conforme
Suitable for Conforme	Suitable for Conforme	Suitable for Conforme	Suitable for Conforme	Suitable for Conforme	Suitable for Conforme	Suitable for Conforme	Suitable for Conforme	Suitable for Conforme	Suitable for Conforme	Suitable for Conforme	Suitable for Conforme	Suitable for Conforme	Suitable for Conforme	Suitable for Conforme	Suitable for Conforme	Suitable for Conforme
Suitable for Conforme	Suitable for Conforme	Suitable for Conforme	Suitable for Conforme	Suitable for Conforme	Suitable for Conforme	Suitable for Conforme	Suitable for Conforme	Suitable for Conforme	Suitable for Conforme	Suitable for Conforme	Suitable for Conforme	Suitable for Conforme	Suitable for Conforme	Suitable for Conforme	Suitable for Conforme	Suitable for Conforme
≤ 0,1 %	≤ 0,1 %	≤ 0,1 %	≤ 0,1 %	≤ 0,1 %	≤ 0,1 %	≤ 0,1 %	≤ 0,1 %	≤ 0,1 %	≤ 0,1 %	≤ 0,1 %	≤ 0,1 %	≤ 0,1 %	≤ 0,1 %	≤ 0,1 %	≤ 0,1 %	≤ 0,1 %
≤ 0,5 %	≤ 0,5 %	≤ 0,5 %	≤ 0,5 %	≤ 0,5 %	≤ 0,5 %	≤ 0,5 %	≤ 0,5 %	≤ 0,5 %	≤ 0,5 %	≤ 0,5 %	≤ 0,5 %	≤ 0,5 %	≤ 0,5 %	≤ 0,5 %	≤ 0,5 %	≤ 0,5 %
S ≥ 1500 N	S ≥ 1500 N	S ≥ 1500 N	S ≥ 1500 N	S ≥ 1500 N	S ≥ 1500 N	S ≥ 2000 N	S ≥ 2000 N	S ≥ 10000 N	S ≥ 1500 N	S ≥ 1000 N	S ≥ 1500 N	S ≥ 1500 N	S ≥ 10000 N	S ≥ 1500 N	S ≥ 1000 N	S ≥ 1500 N
R ≥ 40 N/mm ²	R ≥ 40 N/mm ²	R ≥ 40 N/mm ²	R ≥ 40 N/mm ²	R ≥ 40 N/mm ²	R ≥ 40 N/mm ²	R ≥ 40 N/mm ²	R ≥ 40 N/mm ²	R ≥ 45 N/mm ²	R ≥ 40 N/mm ²	R ≥ 40 N/mm ²	R ≥ 40 N/mm ²	R ≥ 40 N/mm ²	R ≥ 45 N/mm ²	R ≥ 40 N/mm ²	R ≥ 40 N/mm ²	R ≥ 40 N/mm ²
-	-	-	-	-	-	-	-	≥ T11 60x60	-	-	-	-	≥ T11 45x90 40x120	-	-	-
≥ 0,55	≥ 0,55	≥ 0,55	≥ 0,55	≥ 0,55	≥ 0,55	≥ 0,55	≥ 0,55	≥ 0,55	≥ 0,55	≥ 0,55	≥ 0,55	≥ 0,55	≥ 0,55	≥ 0,55	≥ 0,55	≥ 0,55
6	6	8	6	5	7	6	8	8	6	6	5	8	8	6	6	8
≤ 150 mm ³	≤ 150 mm ³	≤ 150 mm ³	≤ 150 mm ³	≤ 150 mm ³	≤ 150 mm ³	≤ 150 mm ³	≤ 150 mm ³	≤ 150 mm ³	≤ 150 mm ³	≤ 150 mm ³	≤ 150 mm ³	≤ 150 mm ³	≤ 150 mm ³	≤ 150 mm ³	≤ 150 mm ³	≤ 150 mm ³
≤ 7 MK ⁻¹	≤ 7 MK ⁻¹	≤ 7 MK ⁻¹	≤ 7 MK ⁻¹	≤ 7 MK ⁻¹	≤ 7 MK ⁻¹	≤ 7 MK ⁻¹	≤ 7 MK ⁻¹	≤ 7 MK ⁻¹	≤ 7 MK ⁻¹	≤ 7 MK ⁻¹	≤ 7 MK ⁻¹	≤ 7 MK ⁻¹	≤ 7 MK ⁻¹	≤ 7 MK ⁻¹	≤ 7 MK ⁻¹	≤ 7 MK ⁻¹
Resistant Resiste	Resistant Resiste	Resistant Resiste	Resistant Resiste	Resistant Resiste	Resistant Resiste	Resistant Resiste	Resistant Resiste	Resistant Resiste	Resistant Resiste	Resistant Resiste	Resistant Resiste	Resistant Resiste	Resistant Resiste	Resistant Resiste	Resistant Resiste	Resistant Resiste
≤ 0,01% (0,1mm/m)	≤ 0,01% (0,1mm/m)	≤ 0,01% (0,1mm/m)	≤ 0,01% (0,1mm/m)	≤ 0,01% (0,1mm/m)	≤ 0,01% (0,1mm/m)	≤ 0,01% (0,1mm/m)	≤ 0,01% (0,1mm/m)	≤ 0,01% (0,1mm/m)	≤ 0,01% (0,1mm/m)	≤ 0,01% (0,1mm/m)	≤ 0,01% (0,1mm/m)	≤ 0,01% (0,1mm/m)	≤ 0,01% (0,1mm/m)	≤ 0,01% (0,1mm/m)	≤ 0,01% (0,1mm/m)	≤ 0,01% (0,1mm/m)
Resistant Resiste	Resistant Resiste	Resistant Resiste	Resistant Resiste	Resistant Resiste	Resistant Resiste	Resistant Resiste	Resistant Resiste	Resistant Resiste	Resistant Resiste	Resistant Resiste	Resistant Resiste	Resistant Resiste	Resistant Resiste	Resistant Resiste	Resistant Resiste	Resistant Resiste
≥ 1,0 N/ mm ² (Class C2 - EN 12004)	≥ 1,0 N/ mm ² (Class C2 - EN 12004)	≥ 1,0 N/ mm ² (Class C2 - EN 12004)	≥ 1,0 N/ mm ² (Class C2 - EN 12004)	≥ 1,0 N/ mm ² (Class C2 - EN 12004)	≥ 1,0 N/ mm ² (Class C2 - EN 12004)	≥ 1,0 N/ mm ² (Class C2 - EN 12004)	≥ 1,0 N/ mm ² (Class C2 - EN 12004)	≥ 1,0 N/mm ² (Class C2 - EN 12004)	≥ 1,0 N/ mm ² (Class C2 - EN 12004)	≥ 1,0 N/ mm ² (Class C2 - EN 12004)	≥ 1,0 N/ mm ² (Class C2 - EN 12004)	≥ 1,0 N/ mm ² (Class C2 - EN 12004)	≥ 1,0 N/ mm ² (Class C2 - EN 12004)	≥ 1,0 N/mm ² (Class C2 - EN 12004)	≥ 1,0 N/mm ² (Class C2 - EN 12004)	≥ 1,0 N/mm ² (Class C2 - EN 12004)
A1 - A1 _{fl}	A1 - A1 _{fl}	A1 - A1 _{fl}	A1 - A1 _{fl}	A1 - A1 _{fl}	A1 - A1 _{fl}	A1 - A1 _{fl}	A1 - A1 _{fl}	A1 - A1 _{fl}	A1 - A1 _{fl}	A1 - A1 _{fl}	A1 - A1 _{fl}	A1 - A1 _{fl}	A1 - A1 _{fl}	A1 - A1 _{fl}	A1 - A1 _{fl}	A1 - A1 _{fl}
A	A	A	A	A	A	A	A	A	A	A	A	A	A	A	A	A
LA	LA	LA	LA	LA	LA	LA	LA	LA	LA	LA	LA	LA	LA	LA	LA	LA
HA	HA	HA	HA	-	HA	HA	HA	HA	HA	HA	-	HA	HA	HA	HA	HA
5	5	5	5	5	5	5	5	5	5	5	5	5	5	5	5	5
R10	R10	R11	R10	N.C.	R11	R10	R11	R11	R10	R9	■	R11	R11	R10	R9	R11
A	A+B	A+B+C	A	0	A+B	A+B	A+B+C	A+B+C	A+B	A	0	A+B+C	A+B+C	A+B	A	A+B+C
≥ 36 Dry ≥ 36 Wet	≥ 36 Dry ≥ 36 Wet	≥ 36 Dry ≥ 36 Wet	≥ 36 Dry ≥ 36 Wet	≥ 36 Dry ≥ 24 Wet	≥ 36 Dry ≥ 36 Wet	≥ 36 Dry ≥ 36 Wet	≥ 36 Dry ≥ 36 Wet	≥ 36 Dry ≥ 36 Wet	≥ 36 Dry ≥ 36 Wet	≥ 36 Dry ≥ 36 Wet	≥ 36 Dry ≥ 36 Wet	≥ 36 Dry ≥ 36 Wet	≥ 36 Dry ≥ 36 Wet	≥ 36 Dry ≥ 36 Wet	≥ 36 Dry ≥ 36 Wet	≥ 36 Dry ≥ 36 Wet
(●●)	Class P3	Class P4	Class P3	-	Class P4	Class P3	Class P4	Class P4	Class P3	(●●)	-	Class P4	Class P4	Class P3	(●●)	Class P4
Class C2	Class C2	Class C3	(●●●)	-	Class C3	Class C2	Class C3	Class C3	Class C2	(●●●)	-	Class C3	Class C3	Class C2	(●●●)	Class C3
> 0,40 Asciutto > 0,40 Bagnato	> 0,40 Asciutto > 0,40 Bagnato	> 0,40 Asciutto > 0,40 Bagnato	> 0,40 Asciutto > 0,40 Bagnato	> 0,40 Asciutto > 0,40 Bagnato	> 0,40 Asciutto > 0,40 Bagnato	> 0,40 Asciutto > 0,40 Bagnato	> 0,40 Asciutto > 0,40 Bagnato	> 0,40 Asciutto > 0,40 Bagnato	> 0,40 Asciutto > 0,40 Bagnato	> 0,40 Asciutto > 0,40 Bagnato	> 0,40 Asciutto > 0,40 Bagnato	> 0,40 Asciutto > 0,40 Bagnato	> 0,40 Asciutto > 0,40 Bagnato	> 0,40 Asciutto > 0,40 Bagnato	> 0,40 Asciutto > 0,40 Bagnato	> 0,40 Asciutto > 0,40 Bagnato
> 0,42 Wet	> 0,42 Wet	> 0,42 Wet	> 0,42 Wet	< 0,42 Wet	> 0,42 Wet	> 0,42 Wet	> 0,42 Wet	> 0,42 Wet	> 0,42 Wet	> 0,42 Wet	✘	> 0,42 Wet	> 0,42 Wet			

		Requirements for nominal size N Requisiti per dimensione nominale N			BOOST		BRAVE			
		7 cm ≤ N < 15 cm (mm)		N ≥ 15 cm (%)	(mm)	Outdoor ✚ 20mm	Matte	Grip	Outdoor ✚ 20mm	
		Length and width Lunghezza e larghezza	± 0,9 (*) Non-rect. ± 0,4 (*) Rect.	± 0,6 (*) Non-rect. ± 0,3 (*) Rect.	± 2,0 (*) Non-rect. ± 1,0 (*) Rect.	Suitable for Conforme	Suitable for Conforme	Suitable for Conforme	Suitable for Conforme	
Regularity characteristics		Thickness Spessore	± 0,5 (**)	± 5 (**)	± 0,5 (**)	Suitable for Conforme	Suitable for Conforme	Suitable for Conforme	Suitable for Conforme	
		Straightness of sides Rettineità degli spigoli	± 0,8 (***) Non-rect. ± 0,4 (***) Rect.	± 0,5 (***) Non-rect. ± 0,3 (***) Rect.	± 1,5 (***) Non-rect. ± 0,8 (***) Rect.	Suitable for Conforme	Suitable for Conforme	Suitable for Conforme	Suitable for Conforme	
		Rectangularity (Measurement only on short edges when L/l ≥ 3) Ortogonalità (Misurazione da condurre solo sui lati corti quando L/l ≥ 3)	± 0,8 (****) Non-rect. ± 0,4 (****) Rect.	± 0,5 (****) Non-rect. ± 0,3 (****) Rect.	± 2,0 (****) Non-rect. ± 1,5 (****) Rect.	Suitable for Conforme	Suitable for Conforme	Suitable for Conforme	Suitable for Conforme	
		Surface flatness Pianarità	c.c. ± 0,8 Non-rect. c.c. ± 0,6 Rect.	c.c. ± 0,5 Non-rect. c.c. ± 0,4 Rect.	c.c. ± 2,0 Non-rect. c.c. ± 1,8 Rect.	Suitable for Conforme	Not applicable to "strong" structures Non applicabile a strutture forti			
	Water absorption (in % by mass) Massa d'acqua assorbita (come % della massa)	ISO 10545-3	E _v ≤ 0,5% Individual max 0,6% E _v ≤ 0,5% Valore max singolo 0,6%			≤ 0,1 %	≤ 0,1 %	≤ 0,1 %	≤ 0,1 %	
Structural characteristics	ASTM C373-18	Requirement ANSI A137.1 Water Absorption Max ≤ 0,5%			≤ 0,5 %	≤ 0,5 %	≤ 0,5 %	≤ 0,5 %		
Bulk mechanical characteristics	Breaking strength Storzo di rottura	ISO 10545-4	S ≥ 700N (for thickness < 7,5 mm - per spessore < 7,5 mm) S ≥ 1300N (for thickness ≥ 7,5 mm - per spessore ≥ 7,5 mm)			S ≥ 10000 N	S ≥ 1500 N	S ≥ 1500 N	S ≥ 10000 N	
	Modulus of rupture Resistenza alla flessione	R ≥ 35 N/mm ²	R ≥ 45 N/mm ²	R ≥ 40 N/mm ²	R ≥ 40 N/mm ²	R ≥ 45 N/mm ²	R ≥ 40 N/mm ²	R ≥ 40 N/mm ²		
	Bonding strength and breaking load Resistenza a flessione e al carico di rottura (4/5)	EN 1339 Annex F	-	≥ T11 120x120 90x90	≥ U4 60x120	-	-	≥ U7 30x60	≥ T11 60x60	≥ U4 45x90 60x120
	Impact resistance, as coefficient of restitution Resistenza all'impatto, espresso come coefficiente di restituzione	ISO 10545-5	Declared value Valore dichiarato			≥ 0,55	≥ 0,55	≥ 0,55	≥ 0,55	
Surface mechanical characteristics	Mohs hardness Durezza Mohs	EN 101	-			8	7	8	8	
	Resistance to deep abrasion of unglazed tiles (removed volume) Resistenza all'abrasione profonda delle piastrelle non smaltate (volume materiale asportato)	ISO 10545-6	≤ 175 mm ³			≤ 150 mm ³	≤ 150 mm ³	≤ 150 mm ³	≤ 150 mm ³	
Thermal and hygrometric characteristics	Coefficient of thermal linear expansion Coefficiente di dilatazione termica lineare	ISO 10545-8	Declared value Valore dichiarato			≤ 7 MK ⁻¹	≤ 7 MK ⁻¹	≤ 7 MK ⁻¹	≤ 7 MK ⁻¹	
	Thermal shock resistance Resistenza agli sbalzi termici	ISO 10545-9	Pass according to EN ISO 10545-1 Test superato in accordo con ISO 10545-1			Resistant Resiste	Resistant Resiste	Resistant Resiste	Resistant Resiste	
	Moisture expansion (in mm/m) Dilatazione all'umidità (in mm/m)	ISO 10545-10	Declared value Valore dichiarato			≤ 0,01% (0,1mm/m)	≤ 0,01% (0,1mm/m)	≤ 0,01% (0,1mm/m)	≤ 0,01% (0,1mm/m)	
	Frost resistance Resistenza al gelo	ISO 10545-12	Pass according to EN ISO 10545-1 Test superato in accordo con ISO 10545-1			Resistant Resiste	Resistant Resiste	Resistant Resiste	Resistant Resiste	
	Bond strength/adhesion for improved cementitious adhesives Adesione a trazione con adesivi cementizi migliorati	EN 1348	Declared value Valore dichiarato			≥ 1,0 N/mm ² (Class C2 - EN 12004)	≥ 1,0 N/mm ² (Class C2 - EN 12004)	≥ 1,0 N/mm ² (Class C2 - EN 12004)	≥ 1,0 N/mm ² (Class C2 - EN 12004)	
Physical properties	Reaction to fire Reazione al fuoco	-	Class A1 or A1 _l Classe A1 oppure A1 _l			A1 - A1 _l	A1 - A1 _l	A1 - A1 _l	A1 - A1 _l	
	Resistance to household chemicals and swimming pool salts Resistenza ai prodotti chimici di uso domestico ed agli additivi per piscina	ISO 10545-13	Minimum Class B Classe minima B			A	A	A	A	
	Resistance to low concentrations of acids and alkalis Resistenza a basse concentrazioni di acidi e alcali	-	Declared Class Classe dichiarata			LA	LA	LA	LA	
	Resistance to high concentrations of acids and alkalis Resistenza ad alte concentrazioni di acidi e alcali	-	Declared Class Classe dichiarata			HA	HA	HA	HA	
Chemical characteristics	Resistance to staining, for unglazed tiles Resistenza alle macchie per piastrelle non smaltate	ISO 10545-14	Declared Class Classe dichiarata			5	5	5	5	
	Shod Ramp Test Metodo della rampa "calzato"	DIN 51130	Declared value Valore dichiarato			R11	R10	R12	R11	
	Barefoot Ramp Test Metodo della rampa a piedi nudi	DIN 51097	Declared value Valore dichiarato			A+B+C	A+B	A+B+C	A+B+C	
	Pendulum Friction Test Metodo del Pendolo	BS 7976	PTV ≥ 36 classifies the surface as "low slip risk"			≥ 36 Dry ≥ 36 Wet	≥ 36 Dry ≥ 36 Wet	≥ 36 Dry ≥ 36 Wet	≥ 36 Dry ≥ 36 Wet	
		AS 4586	Declared Classification of the new pedestrian surface materials according to the Pendulum Test			Class P4	Class P3	Class P4	Class P4	
		UNE-ENV 12633	Declared value Valore dichiarato			Class C3	Class C2	Class C3	Class C3	
	Coefficient of friction (COF) Coefficiente di attrito	B.C.R.A. Rep. CEC/81	D. M. 236/89 del 14/06/89 μ > 0,40 per elemento scivolante cuoio su pavimentazione asciutta μ > 0,40 per elemento scivolante gomma dura su pavimentazione bagnata			> 0,40 Asciutto > 0,40 Bagnato	> 0,40 Asciutto > 0,40 Bagnato	> 0,40 Asciutto > 0,40 Bagnato	> 0,40 Asciutto > 0,40 Bagnato	
Dynamic coefficient of friction (DCOF) Coefficiente di attrito dinamico	ANSI A137.1	ANSI A.137.1-2017 Requires a minimum value of 0.42 for level interior space expected to be walked upon when wet. (3)			> 0,42 Wet	> 0,42 Wet	> 0,42 Wet	> 0,42 Wet		

DOLMEN PRO				DWELL			ECHO	ETIC		ETIC PRO			EVOLVE	
Matte	Grip	Textured	Outdoor ✚ 20mm	Matte	Polished	Outdoor ✚ 20mm	Outdoor ✚ 20mm	Matte	Textured	Matte	Grip	Outdoor ✚ 20mm	Matte	Textured
Suitable for Conforme	Suitable for Conforme	Suitable for Conforme	Suitable for Conforme	Suitable for Conforme	Suitable for Conforme	Suitable for Conforme	Suitable for Conforme	Suitable for Conforme	Suitable for Conforme	Suitable for Conforme	Suitable for Conforme	Suitable for Conforme	Suitable for Conforme	Suitable for Conforme
Suitable for Conforme	Suitable for Conforme	Suitable for Conforme	Suitable for Conforme	Suitable for Conforme	Suitable for Conforme	Suitable for Conforme	Suitable for Conforme	Suitable for Conforme	Suitable for Conforme	Suitable for Conforme	Suitable for Conforme	Suitable for Conforme	Suitable for Conforme	Suitable for Conforme
Suitable for Conforme	Suitable for Conforme	Suitable for Conforme	Suitable for Conforme	Suitable for Conforme	Suitable for Conforme	Suitable for Conforme	Suitable for Conforme	Suitable for Conforme	Suitable for Conforme	Suitable for Conforme	Suitable for Conforme	Suitable for Conforme	Suitable for Conforme	Suitable for Conforme
Not applicable to "strong" structures Non applicabile a strutture forti				Suitable for Conforme	Suitable for Conforme	Suitable for Conforme	Not applicable to "strong" structures Non applicabile a strutture forti	Suitable for Conforme	Not applicable to "strong" structures Non applicabile a strutture forti	Suitable for Conforme	Suitable for Conforme	Not applicable to "strong" structures Non applicabile a strutture forti	Suitable for Conforme	Not applicable to "strong" structures Non applicabile a strutture forti
≤ 0,1 %	≤ 0,1 %	≤ 0,1 %	≤ 0,1 %	≤ 0,1 %	≤ 0,1 %	≤ 0,1 %	≤ 0,1 %	≤ 0,1 %	≤ 0,1 %	≤ 0,1 %	≤ 0,1 %	≤ 0,1 %	≤ 0,1 %	≤ 0,1 %
≤ 0,5 %	≤ 0,5 %	≤ 0,5 %	≤ 0,5 %	≤ 0,5 %	≤ 0,5 %	≤ 0,5 %	≤ 0,5 %	≤ 0,5 %	≤ 0,5 %	≤ 0,5 %	≤ 0,5 %	≤ 0,5 %	≤ 0,5 %	≤ 0,5 %
S ≥ 1500 N	S ≥ 1500 N	S ≥ 1500 N	S ≥ 10000 N	S ≥ 1500 N	S ≥ 1500 N	S ≥ 10000 N	S ≥ 10000 N	S ≥ 2000 N	S ≥ 2000 N	S ≥ 1500 N	S ≥ 1500 N	S ≥ 10000 N	S ≥ 1500 N	S ≥ 1500 N
R ≥ 40 N/mm ²	R ≥ 40 N/mm ²	R ≥ 40 N/mm ²	R ≥ 45 N/mm ²	R ≥ 40 N/mm ²	R ≥ 40 N/mm ²	R ≥ 45 N/mm ²	R ≥ 45 N/mm ²	R ≥ 40 N/mm ²	R ≥ 40 N/mm ²	R ≥ 40 N/mm ²	R ≥ 40 N/mm ²	R ≥ 45 N/mm ²	R ≥ 40 N/mm ²	R ≥ 40 N/mm ²
-	-	-	≥ T11 22,5x22,5 ≥ U4 60x120 22,5x45,4	-	-	≥ T11 90x90	≥ T11 90x90	-	-	-	-	≥ U3 30x120	-	-
≥ 0,55	≥ 0,55	≥ 0,55	≥ 0,55	≥ 0,55	≥ 0,55	≥ 0,55	≥ 0,55	≥ 0,55	≥ 0,55	≥ 0,55	≥ 0,55	≥ 0,55	≥ 0,55	≥ 0,55
7	8	8	8	6	5	8	8	6	8	6	8	8	6	8
≤ 150 mm ³	≤ 150 mm ³	≤ 150 mm ³	≤ 150 mm ³	≤ 150 mm ³	≤ 150 mm ³	≤ 150 mm ³	≤ 150 mm ³	≤ 150 mm ³	≤ 150 mm ³	≤ 150 mm ³	≤ 150 mm ³	≤ 150 mm ³	≤ 150 mm ³	≤ 150 mm ³
≤ 7 MK ⁻¹	≤ 7 MK ⁻¹	≤ 7 MK ⁻¹	≤ 7 MK ⁻¹	≤ 7 MK ⁻¹	≤ 7 MK ⁻¹	≤ 7 MK ⁻¹	≤ 7 MK ⁻¹	≤ 7 MK ⁻¹	≤ 7 MK ⁻¹	≤ 7 MK ⁻¹	≤ 7 MK ⁻¹	≤ 7 MK ⁻¹	≤ 7 MK ⁻¹	≤ 7 MK ⁻¹
Resistant Resiste	Resistant Resiste	Resistant Resiste	Resistant Resiste	Resistant Resiste	Resistant Resiste	Resistant Resiste	Resistant Resiste	Resistant Resiste	Resistant Resiste	Resistant Resiste	Resistant Resiste	Resistant Resiste	Resistant Resiste	Resistant Resiste
≤ 0,01% (0,1mm/m)	≤ 0,01% (0,1mm/m)	≤ 0,01% (0,1mm/m)	≤ 0,01% (0,1mm/m)	≤ 0,01% (0,1mm/m)	≤ 0,01% (0,1mm/m)	≤ 0,01% (0,1mm/m)	≤ 0,01% (0,1mm/m)	≤ 0,01% (0,1mm/m)	≤ 0,01% (0,1mm/m)	≤ 0,01% (0,1mm/m)	≤ 0,01% (0,1mm/m)	≤ 0,01% (0,1mm/m)	≤ 0,01% (0,1mm/m)	≤ 0,01% (0,1mm/m)
Resistant Resiste	Resistant Resiste	Resistant Resiste	Resistant Resiste	Resistant Resiste	Resistant Resiste	Resistant Resiste	Resistant Resiste	Resistant Resiste	Resistant Resiste	Resistant Resiste	Resistant Resiste	Resistant Resiste	Resistant Resiste	Resistant Resiste
≥ 1,0 N/mm ² (Class C2 - EN 12004)	≥ 1,0 N/mm ² (Class C2 - EN 12004)	≥ 1,0 N/mm ² (Class C2 - EN 12004)	≥ 1,0 N/mm ² (Class C2 - EN 12004)	≥ 1,0 N/mm ² (Class C2 - EN 12004)	≥ 1,0 N/mm ² (Class C2 - EN 12004)	≥ 1,0 N/mm ² (Class C2 - EN 12004)	≥ 1,0 N/mm ² (Class C2 - EN 12004)	≥ 1,0 N/mm ² (Class C2 - EN 12004)	≥ 1,0 N/mm ² (Class C2 - EN 12004)	≥ 1,0 N/mm ² (Class C2 - EN 12004)	≥ 1,0 N/mm ² (Class C2 - EN 12004)	≥ 1,0 N/mm ² (Class C2 - EN 12004)	≥ 1,0 N/mm ² (Class C2 - EN 12004)	≥ 1,0 N/mm ² (Class C2 - EN 12004)
A1 - A1 _l	A1 - A1 _l	A1 - A1 _l	A1 - A1 _l	A1 - A1 _l	A1 - A1 _l	A1 - A1 _l	A1 - A1 _l	A1 - A1 _l	A1 - A1 _l	A1 - A1 _l	A1 - A1 _l	A1 - A1 _l	A1 - A1 _l	A1 - A1 _l
A	A	A	A	A	A	A	A	A	A	A	A	A	A	A
LA	LA	LA	LA	LA	LA	LA	LA	LA	LA	LA	LA	LA	LA	LA
HA	HA	HA	HA	HA	-	HA	HA	HA	HA	HA	HA	HA	HA	HA
5	5	5	5	5	5	5	5	5	5	5	5	5	5	5
R10	R11	R11	R11	R9	N.C.	R11	R11	R9	R11	R9	R11	R11	R9	R11
A+B	A+B+C	A+B+C	A+B+C	A	0	A+B+C	A+B+C	A	A+B+C	A	A+B+C	A+B+C	A	A+B+C
≥ 36 Dry ≥ 36 Wet	≥ 36 Dry ≥ 36 Wet	≥ 36 Dry ≥ 36 Wet	≥ 36 Dry ≥ 36 Wet	(●)	≥ 36 Dry < 24 Wet	≥ 36 Dry ≥ 36 Wet	≥ 36 Dry ≥ 36 Wet	(●)	≥ 36 Dry ≥ 36 Wet	(●)	≥ 36 Dry ≥ 36 Wet	≥ 36 Dry ≥ 36 Wet	(●)	≥ 36 Dry ≥ 36 Wet
Class P3	Class P4	Class P4	Class P4	(●●)	-	Class P4	Class P4	(●●)	Class P4	(●●)	Class P4	Class P4	(●●)	Class P4
Class C2	Class C3	Class C3	Class C3	(●●●)	-	Class C3	Class C3	(●●●)	Class C3	(●●●)	Class C3	Class C3	(●●●)	Class C3
> 0,40 Asciutto > 0,40 Bagnato	> 0,40 Asciutto > 0,40 Bagnato	> 0,40 Asciutto > 0,40 Bagnato	> 0,40 Asciutto > 0,40 Bagnato	> 0,40 Asciutto > 0,40 Bagnato	> 0,40 Asciutto > 0,40 Bagnato	> 0,40 Asciutto > 0,40 Bagnato	> 0,40 Asciutto > 0,40 Bagnato	> 0,40 Asciutto > 0,40 Bagnato	> 0,40 Asciutto > 0,40 Bagnato	> 0,40 Asciutto > 0,40 Bagnato	> 0,40 Asciutto > 0,40 Bagnato	> 0,40 Asciutto > 0,40 Bagnato	> 0,40 Asciutto > 0,40 Bagnato	> 0,40 Asciutto > 0,40 Bagnato
> 0,42 Wet	> 0,42 Wet	> 0,42 Wet	> 0,42 Wet	> 0,42 Wet	< 0,42 Wet	> 0,42 Wet	> 0,42 Wet	> 0,42 Wet	> 0,42 Wet	> 0,42 Wet	> 0,42 Wet	> 0,42 Wet	> 0,42 Wet	> 0,42 Wet

			Requirements for nominal size N Requisiti per dimensione nominale N			EXENCE			GRANIGLIATI		
			7 cm ≤ N < 15 cm (mm)	N ≥ 15 cm (%) (mm)		Matte	Grip	Outdoor ≥20mm	Matte 30x30	Textured 30x30	
Regularity characteristics		Length and width Lunghezza e larghezza	± 0,9 (*) Non-rect. ± 0,4 (*) Rect.	± 0,6 (*) Non-rect. ± 0,3 (*) Rect.	± 2,0 (*) Non-rect. ± 1,0 (*) Rect.	Suitable for Conforme	Suitable for Conforme	Suitable for Conforme	Suitable for Conforme	Suitable for Conforme	
		Thickness Spessore	± 0,5 (**)	± 5 (**)		Suitable for Conforme	Suitable for Conforme	Suitable for Conforme	Suitable for Conforme	Suitable for Conforme	
		Straightness of sides Rettilineità degli spigoli	± 0,8 (***) Non-rect. ± 0,4 (***) Rect.	± 0,5 (***) Non-rect. ± 0,3 (***) Rect.	± 1,5 (***) Non-rect. ± 0,8 (***) Rect.	Suitable for Conforme	Suitable for Conforme	Suitable for Conforme	Suitable for Conforme	Suitable for Conforme	
		Rectangularity (Measurement only on short edges when L/l ≥ 3) Ortogonalità (Misurazione da condurre solo sui lati corti quando L/l ≥ 3)	± 0,8 (****) Non-rect. ± 0,4 (****) Rect.	± 0,5 (****) Non-rect. ± 0,3 (****) Rect.	± 2,0 (****) Non-rect. ± 1,5 (****) Rect.	Suitable for Conforme	Suitable for Conforme	Suitable for Conforme	Suitable for Conforme	Suitable for Conforme	
Structural characteristics		Surface flatness Planarità	c.c. ± 0,8 Non-rect. e.c. ± 0,6 Rect.	c.c. ± 0,5 Non-rect. e.c. ± 0,4 Rect.	c.c. ± 2,0 Non-rect. e.c. ± 1,8 Rect.	Suitable for Conforme	Suitable for Conforme	Not applicable to "strong" structures Non applicabile a strutturati forti	Suitable for Conforme	Not applicable to "strong" structures Non applicabile a strutturati forti	
		Water absorption (in % by mass) Massa d'acqua assorbita (come % della massa)	E _a ≤ 0,5% Individual max 0,6% E _a ≤ 0,5% Valore max singolo 0,6%			≤ 0,1 %	≤ 0,1 %	≤ 0,1 %	≤ 0,1 %	≤ 0,1 %	
		Requirement ANSI A137.1 Water Absorption Max ≤ 0,5%	Requirement ANSI A137.1 Water Absorption Max ≤ 0,5%			≤ 0,5 %	≤ 0,5 %	≤ 0,5 %	≤ 0,5 %	≤ 0,5 %	
		Breaking strength Sforzo di rottura	S ≥ 700N (for thickness < 7,5 mm - per spessore < 7,5 mm) S ≥ 1300N (for thickness ≥ 7,5 mm - per spessore ≥ 7,5 mm)			S ≥ 1500 N	S ≥ 1500 N	S ≥ 10000 N	S ≥ 1500 N	S ≥ 1500 N	
Bulk mechanical characteristics		Modulus of rupture Resistenza alla flessione	R ≥ 35 N/mm ²			R ≥ 40 N/mm ²	R ≥ 40 N/mm ²	R ≥ 45 N/mm ²	R ≥ 40 N/mm ²	R ≥ 40 N/mm ²	
		Bending strength and breaking load Resistenza a flessione e al carico di rottura (4)(5)	-			-	-	≥ T11 60x60	≥ U3 30x120	-	-
		Impact resistance, as coefficient of restitution Resistenza all'impatto, espresso come coefficiente di restituzione	Declared value Valore dichiarato			≥ 0,55	≥ 0,55	≥ 0,55	≥ 0,55	≥ 0,55	
Surface mechanical characteristics		Mohs hardness Durezza Mohs	-			6	8	8	6	7	
		Resistance to deep abrasion of unglazed tiles (removed volume) Resistenza all'abrasione profonda delle piastrelle non smaltate (volume materiale asportato)	≤ 175 mm ³			≤ 150 mm ³	≤ 150 mm ³	≤ 150 mm ³	≤ 150 mm ³	≤ 150 mm ³	
Thermal and hygrometric characteristics		Coefficient of thermal linear expansion Coefficiente di dilatazione termica lineare	Declared value Valore dichiarato			≤ 7 MK ⁻¹	≤ 7 MK ⁻¹	≤ 7 MK ⁻¹	≤ 7 MK ⁻¹	≤ 7 MK ⁻¹	
		Thermal shock resistance Resistenza agli sbalzi termici	Pass according to EN ISO 10545-1 Test superato in accordo con ISO 10545-1			Resistant Resiste	Resistant Resiste	Resistant Resiste	Resistant Resiste	Resistant Resiste	
		Moisture expansion (in mm/m) Dilatazione all'umidità (in mm/m)	Declared value Valore dichiarato			≤ 0,01% (0,1mm/m)	≤ 0,01% (0,1mm/m)	≤ 0,01% (0,1mm/m)	≤ 0,01% (0,1mm/m)	≤ 0,01% (0,1mm/m)	
		Frost resistance Resistenza al gelo	Pass according to EN ISO 10545-1 Test superato in accordo con ISO 10545-1			Resistant Resiste	Resistant Resiste	Resistant Resiste	Resistant Resiste	Resistant Resiste	
Physical properties		Bond strength/adhesion for improved cementitious adhesives Adesione a trazione con adesivi cementizi migliorati	Declared value Valore dichiarato			≥ 1,0 N/mm ² (Class C2 - EN 12004)	≥ 1,0 N/mm ² (Class C2 - EN 12004)	≥ 1,0 N/mm ² (Class C2 - EN 12004)	≥ 1,0 N/mm ² (Class C2 - EN 12004)	≥ 1,0 N/mm ² (Class C2 - EN 12004)	
		Reaction to fire Reazione al fuoco	Class A1 or A1 _n Classe A1 oppure A1 _n			A1 - A1 _n	A1 - A1 _n	A1 - A1 _n	A1 - A1 _n	A1 - A1 _n	
Chemical characteristics		Resistance to household chemicals and swimming pool salts Resistenza ai prodotti chimici di uso domestico ed agli additivi per piscina	Minimum Class B Classe minima B			A	A	A	A	A	
		Resistance to low concentrations of acids and alkalis Resistenza a basse concentrazioni di acidi e alcali	Declared Class Classe dichiarata			LA	LA	LA	LA	LA	
		Resistance to high concentrations of acids and alkalis Resistenza ad alte concentrazioni di acidi e alcali	Declared Class Classe dichiarata			HA	HA	HA	HA	HA	
Safety characteristics (1)(2)		Shod Ramp Test Metodo della rampa "calzato"	Declared value Valore dichiarato			R10	R11	R11	R9	R11	
		Barefoot Ramp Test Metodo della rampa a piedi nudi	Declared value Valore dichiarato			A+B	A+B+C	A+B+C	A	A+B	
		Pendulum Friction Test Metodo del Pendolo	PTV ≥ 36 classifies the surface as "low slip risk"			≥ 36 Dry ≥ 36 Wet	≥ 36 Dry ≥ 36 Wet	≥ 36 Dry ≥ 36 Wet	☉	≥ 36 Dry ≥ 36 Wet	
			Declared Classification of the new pedestrian surface materials according to the Pendulum Test			Class P3	Class P4	Class P4	☉☉	Class P3	
			Declared value Valore dichiarato			Class C2	Class C3	Class C3	☉☉☉	Class C3	
		Coefficient of friction (COF) Coefficiente di attrito	D. M. 236/89 del 14/06/89 μ > 0,40 per elemento scivolante cuoio su pavimentazione asciutta μ > 0,40 per elemento scivolante gomma dura su pavimentazione bagnata			> 0,40 Asciutto > 0,40 Bagnato	> 0,40 Asciutto > 0,40 Bagnato	> 0,40 Asciutto > 0,40 Bagnato	> 0,40 Asciutto > 0,40 Bagnato	> 0,40 Asciutto > 0,40 Bagnato	
Dynamic coefficient of friction (DCOF) Coefficiente di attrito dinamico	ANSI A.137.1-2017 Requires a minimum value of 0.42 for level interior space expected to be walked upon when wet. (3)			> 0,42 Wet	> 0,42 Wet	> 0,42 Wet	> 0,42 Wet	> 0,42 Wet			

GRANIGLIATI				GROUND TRACK				HEARTWOOD		KLIF			KONE		
Matte 20x20 ± 7,6mm	Matte 20x20 ± 12mm	Textured 20x20 ± 7,6mm	Anti-slip type P di Diamante 20x20	Stop	Turn	Go	Cross	Matte 18,5x150mm	Matte 20x120mm	Matte	Grip	Outdoor ± 20mm	Matte	Matte ± 6mm	Polished
Suitable for Conforme	Suitable for Conforme	Suitable for Conforme	Suitable for Conforme	Suitable for Conforme	Suitable for Conforme	Suitable for Conforme	Suitable for Conforme	Suitable for Conforme	Suitable for Conforme	Suitable for Conforme	Suitable for Conforme	Suitable for Conforme	Suitable for Conforme	Suitable for Conforme	Suitable for Conforme
Suitable for Conforme	Suitable for Conforme	Suitable for Conforme	Suitable for Conforme	Suitable for Conforme	Suitable for Conforme	Suitable for Conforme	Suitable for Conforme	Suitable for Conforme	Suitable for Conforme	Suitable for Conforme	Suitable for Conforme	Suitable for Conforme	Suitable for Conforme	Suitable for Conforme	Suitable for Conforme
Suitable for Conforme	Suitable for Conforme	Suitable for Conforme	Suitable for Conforme	Suitable for Conforme	Suitable for Conforme	Suitable for Conforme	Suitable for Conforme	Suitable for Conforme	Suitable for Conforme	Suitable for Conforme	Suitable for Conforme	Suitable for Conforme	Suitable for Conforme	Suitable for Conforme	Suitable for Conforme
Suitable for Conforme	Suitable for Conforme	Suitable for Conforme	Suitable for Conforme	Suitable for Conforme	Suitable for Conforme	Suitable for Conforme	Suitable for Conforme	Suitable for Conforme	Suitable for Conforme	Suitable for Conforme	Suitable for Conforme	Suitable for Conforme	Suitable for Conforme	Suitable for Conforme	Suitable for Conforme
Suitable for Conforme	Suitable for Conforme	Suitable for Conforme	Suitable for Conforme	Suitable for Conforme	Suitable for Conforme	Suitable for Conforme	Suitable for Conforme	Suitable for Conforme	Suitable for Conforme	Suitable for Conforme	Suitable for Conforme	Suitable for Conforme	Suitable for Conforme	Suitable for Conforme	Suitable for Conforme
Suitable for Conforme	Suitable for Conforme	Suitable for Conforme	Suitable for Conforme	Suitable for Conforme	Suitable for Conforme	Suitable for Conforme	Suitable for Conforme	Suitable for Conforme	Suitable for Conforme	Suitable for Conforme	Suitable for Conforme	Suitable for Conforme	Suitable for Conforme	Suitable for Conforme	Suitable for Conforme
Suitable for Conforme	Suitable for Conforme	Suitable for Conforme	Suitable for Conforme	Suitable for Conforme	Suitable for Conforme	Suitable for Conforme	Suitable for Conforme	Suitable for Conforme	Suitable for Conforme	Suitable for Conforme	Suitable for Conforme	Suitable for Conforme	Suitable for Conforme	Suitable for Conforme	Suitable for Conforme
Suitable for Conforme	Suitable for Conforme	Suitable for Conforme	Suitable for Conforme	Suitable for Conforme	Suitable for Conforme	Suitable for Conforme	Suitable for Conforme	Suitable for Conforme	Suitable for Conforme	Suitable for Conforme	Suitable for Conforme	Suitable for Conforme	Suitable for Conforme	Suitable for Conforme	Suitable for Conforme
Suitable for Conforme	Suitable for Conforme	Suitable for Conforme	Suitable for Conforme	Suitable for Conforme	Suitable for Conforme	Suitable for Conforme	Suitable for Conforme	Suitable for Conforme	Suitable for Conforme	Suitable for Conforme	Suitable for Conforme	Suitable for Conforme	Suitable for Conforme	Suitable for Conforme	Suitable for Conforme
Suitable for Conforme	Suitable for Conforme	Suitable for Conforme	Suitable for Conforme	Suitable for Conforme	Suitable for Conforme	Suitable for Conforme	Suitable for Conforme	Suitable for Conforme	Suitable for Conforme	Suitable for Conforme	Suitable for Conforme	Suitable for Conforme	Suitable for Conforme	Suitable for Conforme	Suitable for Conforme
Suitable for Conforme	Suitable for Conforme	Suitable for Conforme	Suitable for Conforme	Suitable for Conforme	Suitable for Conforme	Suitable for Conforme	Suitable for Conforme	Suitable for Conforme	Suitable for Conforme	Suitable for Conforme	Suitable for Conforme	Suitable for Conforme	Suitable for Conforme	Suitable for Conforme	Suitable for Conforme
Suitable for Conforme	Suitable for Conforme	Suitable for Conforme	Suitable for Conforme	Suitable for Conforme	Suitable for Conforme	Suitable for Conforme	Suitable for Conforme	Suitable for Conforme	Suitable for Conforme	Suitable for Conforme	Suitable for Conforme	Suitable for Conforme	Suitable for Conforme	Suitable for Conforme	Suitable for Conforme
Suitable for Conforme	Suitable for Conforme	Suitable for Conforme	Suitable for Conforme	Suitable for Conforme	Suitable for Conforme	Suitable for Conforme	Suitable for Conforme	Suitable for Conforme	Suitable for Conforme	Suitable for Conforme	Suitable for Conforme	Suitable for Conforme	Suitable for Conforme	Suitable for Conforme	Suitable for Conforme
Suitable for Conforme	Suitable for Conforme	Suitable for Conforme	Suitable for Conforme	Suitable for Conforme	Suitable for Conforme	Suitable for Conforme	Suitable for Conforme	Suitable for Conforme	Suitable for Conforme	Suitable for Conforme	Suitable for Conforme	Suitable for Conforme	Suitable for Conforme	Suitable for Conforme	Suitable for Conforme
Suitable for Conforme	Suitable for Conforme	Suitable for Conforme	Suitable for Conforme	Suitable for Conforme	Suitable for Conforme	Suitable for Conforme	Suitable for Conforme	Suitable for Conforme	Suitable for Conforme	Suitable for Conforme	Suitable for Conforme	Suitable for Conforme	Suitable for Conforme	Suitable for Conforme	Suitable for Conforme
Suitable for Conforme	Suitable for Conforme	Suitable for Conforme	Suitable for Conforme	Suitable for Conforme	Suitable for Conforme	Suitable for Conforme	Suitable for Conforme	Suitable for Conforme	Suitable for Conforme	Suitable for Conforme	Suitable for Conforme	Suitable for Conforme	Suitable for Conforme	Suitable for Conforme	Suitable for Conforme
Suitable for Conforme	Suitable for Conforme	Suitable for Conforme	Suitable for Conforme	Suitable for Conforme	Suitable for Conforme	Suitable for Conforme	Suitable for Conforme	Suitable for Conforme	Suitable for Conforme	Suitable for Conforme	Suitable for Conforme	Suitable for Conforme	Suitable for Conforme	Suitable for Conforme	Suitable for Conforme
Suitable for Conforme	Suitable for Conforme	Suitable for Conforme	Suitable for Conforme	Suitable for Conforme	Suitable for Conforme	Suitable for Conforme	Suitable for Conforme	Suitable for Conforme	Suitable for Conforme	Suitable for Conforme	Suitable for Conforme	Suitable for Conforme	Suitable for Conforme	Suitable for Conforme	Suitable for Conforme
Suitable for Conforme	Suitable for Conforme	Suitable for Conforme	Suitable for Conforme	Suitable for Conforme	Suitable for Conforme	Suitable for Conforme	Suitable for Conforme	Suitable for Conforme	Suitable for Conforme	Suitable for Conforme	Suitable for Conforme	Suitable for Conforme	Suitable for Conforme	Suitable for Conforme	Suitable for Conforme
Suitable for Conforme	Suitable for Conforme	Suitable for Conforme	Suitable for Conforme	Suitable for Conforme	Suitable for Conforme	Suitable for Conforme	Suitable for Conforme	Suitable for Conforme	Suitable for Conforme	Suitable for Conforme	Suitable for Conforme	Suitable for Conforme	Suitable for Conforme	Suitable for Conforme	Suitable for Conforme
Suitable for Conforme	Suitable for Conforme	Suitable for Conforme	Suitable for Conforme	Suitable for Conforme	Suitable for Conforme	Suitable for Conforme	Suitable for Conforme	Suitable for Conforme	Suitable for Conforme	Suitable for Conforme	Suitable for Conforme	Suitable for Conforme	Suitable for Conforme	Suitable for Conforme	Suitable for Conforme
Suitable for Conforme	Suitable for Conforme	Suitable for Conforme	Suitable for Conforme	Suitable for Conforme	Suitable for Conforme	Suitable for Conforme	Suitable for Conforme	Suitable for Conforme	Suitable for Conforme	Suitable for Conforme	Suitable for Conforme	Suitable for Conforme	Suitable for Conforme	Suitable for Conforme	Suitable for Conforme
Suitable for Conforme	Suitable for Conforme	Suitable for Conforme	Suitable for Conforme	Suitable for Conforme	Suitable for Conforme	Suitable for Conforme	Suitable for Conforme	Suitable for Conforme	Suitable for Conforme	Suitable for Conforme	Suitable for Conforme	Suitable for Conforme	Suitable for Conforme	Suitable for Conforme	Suitable for Conforme
Suitable for Conforme	Suitable for Conforme	Suitable for Conforme	Suitable for Conforme	Suitable for Conforme	Suitable for Conforme	Suitable for Conforme	Suitable for Conforme	Suitable for Conforme	Suitable for Conforme	Suitable for Conforme	Suitable for Conforme	Suitable for Conforme	Suitable for Conforme	Suitable for Conforme	Suitable for Conforme
Suitable for Conforme	Suitable for Conforme	Suitable for Conforme	Suitable for Conforme	Suitable for Conforme	Suitable for Conforme	Suitable for Conforme	Suitable for Conforme	Suitable for Conforme	Suitable for Conforme	Suitable for Conforme	Suitable for Conforme	Suitable for Conforme	Suitable for Conforme	Suitable for Conforme	Suitable for Conforme
Suitable for Conforme	Suitable for Conforme	Suitable for Conforme	Suitable for Conforme	Suitable for Conforme	Suitable for Conforme	Suitable for Conforme	Suitable for Conforme	Suitable for Conforme	Suitable for Conforme	Suitable for Conforme	Suitable for Conforme	Suitable for Conforme	Suitable for Conforme	Suitable for Conforme	Suitable for Conforme
Suitable for Conforme	Suitable for Conforme	Suitable for Conforme	Suitable for Conforme	Suitable for Conforme	Suitable for Conforme	Suitable for Conforme	Suitable for Conforme	Suitable for Conforme	Suitable for Conforme	Suitable for Conforme	Suitable for Conforme	Suitable for Conforme	Suitable for Conforme	Suitable for Conforme	Suitable for Conforme
Suitable for Conforme	Suitable for Conforme	Suitable for Conforme	Suitable for Conforme	Suitable for Conforme	Suitable for Conforme	Suitable for Conforme	Suitable for Conforme	Suitable for Conforme	Suitable for Conforme	Suitable for Conforme	Suitable for Conforme	Suitable for Conforme	Suitable for Conforme	Suitable for Conforme	Suitable for Conforme
Suitable for Conforme	Suitable for Conforme	Suitable for Conforme	Suitable for Conforme	Suitable for Conforme	Suitable for Conforme	Suitable for Conforme	Suitable for Conforme	Suitable for Conforme	Suitable for Conforme	Suitable for Conforme	Suitable for Conforme	Suitable for Conforme	Suitable for Conforme	Suitable for Conforme	Suitable for Conforme
Suitable for Conforme	Suitable for Conforme	Suitable for Conforme	Suitable for Conforme	Suitable for Conforme	Suitable for Conforme	Suitable for Conforme	Suitable for Conforme	Suitable for Conforme	Suitable for Conforme	Suitable for Conforme	Suitable for Conforme	Suitable for Conforme	Suitable for Conforme	Suitable for Conforme	Suitable for Conforme
Suitable for Conforme	Suitable for Conforme	Suitable for Conforme	Suitable for Conforme	Suitable for Conforme	Suitable for Conforme	Suitable for Conforme	Suitable for Conforme	Suitable for Conforme	Suitable for Conforme	Suitable for Conforme	Suitable for Conforme	Suitable for Conforme	Suitable for Conforme	Suitable for Conforme	Suitable for Conforme
Suitable for Conforme	Suitable for Conforme	Suitable for Conforme	Suitable for Conforme	Suitable for Conforme	Suitable for Conforme	Suitable for Conforme	Suitable for Conforme	Suitable for Conforme	Suitable for Conforme	Suitable for Conforme	Suitable for Conforme	Suitable for Conforme	Suitable for Conforme	Suitable for Conforme	Suitable for Conforme
Suitable for Conforme	Suitable for Conforme	Suitable for Conforme	Suitable for Conforme	Suitable for Conforme	Suitable for Conforme	Suitable for Conforme	Suitable for Conforme	Suitable for Conforme	Suitable for Conforme	Suitable for Conforme	Suitable for Conforme	Suitable for Conforme	Suitable for Conforme	Suitable for Conforme	Suitable for Conforme
Suitable for Conforme	Suitable for Conforme	Suitable for Conforme	Suitable for Conforme	Suitable for Conforme	Suitable for Conforme	Suitable for Conforme	Suitable for Conforme	Suitable for Conforme	Suitable for Conforme	Suitable for Conforme	Suitable for Conforme	Suitable for Conforme	Suitable for Conforme	Suitable for Conforme	Suitable for Conforme
Suitable for Conforme	Suitable for Conforme	Suitable for Conforme	Suitable for Conforme	Suitable for Conforme	Suitable for Conforme	Suitable for Conforme	Suitable for Conforme	Suitable for Conforme	Suitable for Conforme	Suitable for Conforme	Suitable for Conforme	Suitable for Conforme	Suitable for Conforme	Suitable for Conforme	Suitable for Conforme
Suitable for Conforme	Suitable for Conforme	Suitable for Conforme	Suitable for Conforme	Suitable for Conforme	Suitable for Conforme	Suitable for Conforme	Suitable for Conforme	Suitable for Conforme	Suitable for Conforme	Suitable for Conforme	Suitable for Conforme	Suitable for Conforme	Suitable for Conforme	Suitable for Conforme	Suitable for Conforme
Suitable for Conforme	Suitable for Conforme	Suitable for Conforme	Suitable for Conforme	Suitable for Conforme	Suitable for Conforme	Suitable for Conforme	Suitable for Conforme	Suitable for Conforme	Suitable for Conforme	Suitable for Conforme	Suitable for Conforme	Suitable for Conforme	Suitable for Conforme	Suitable for Conforme	Suitable for Conforme
Suitable for Conforme	Suitable for Conforme	Suitable for Conforme	Suitable for Conforme	Suitable for Conforme	Suitable for Conforme	Suitable for Conforme	Suitable for Conforme	Suitable for Conforme	Suitable for Conforme	Suitable for Conforme	Suitable for Conforme	Suitable for Conforme	Suitable for Conforme	Suitable for Conforme	Suitable for Conforme
Suitable for Conforme	Suitable for 														

		Requirements for nominal size N Requisiti per dimensione nominale N			KONE		MARK		
		7 cm ≤ N < 15 cm	N ≥ 15 cm		Grip	Outdoor ✱ 20mm	Polished	Matte	Textured
		(mm)	(%)	(mm)					
Regularity characteristics	Length and width Lunghezza e larghezza	± 0,9 (*) Non-rect. ± 0,4 (*) Rect.	± 0,6 (*) Non-rect. ± 0,3 (*) Rect.	± 2,0 (*) Non-rect. ± 1,0 (*) Rect.	Suitable for Conforme	Suitable for Conforme	Suitable for Conforme	Suitable for Conforme	Suitable for Conforme
	Thickness Spessore	± 0,5 (**)	± 5 (**)	± 0,5 (**)	Suitable for Conforme	Suitable for Conforme	Suitable for Conforme	Suitable for Conforme	Suitable for Conforme
	Straightness of sides Rettilineità degli spigoli	± 0,8 (***) Non-rect. ± 0,4 (***) Rect.	± 0,5 (***) Non-rect. ± 0,3 (***) Rect.	± 1,5 (***) Non-rect. ± 0,8 (***) Rect.	Suitable for Conforme	Suitable for Conforme	Suitable for Conforme	Suitable for Conforme	Suitable for Conforme
	Rectangularity (Measurement only on short edges when L/l ≥ 3) Ortogonalità (Misurazione da condurre solo sui lati corti quando L/l ≥ 3)	± 0,8 (****) Non-rect. ± 0,4 (****) Rect.	± 0,5 (****) Non-rect. ± 0,3 (****) Rect.	± 2,0 (****) Non-rect. ± 1,5 (****) Rect.	Suitable for Conforme	Suitable for Conforme	Suitable for Conforme	Suitable for Conforme	Suitable for Conforme
Surface flatness Planarità	ISO 10545-2	c.c. ± 0,8 Non-rect. c.c. ± 0,6 Rect.	c.c. ± 0,5 Non-rect. c.c. ± 0,4 Rect.	c.c. ± 2,0 Non-rect. c.c. ± 1,8 Rect.	Suitable for Conforme	Not applicable to "strong" structures Non applicabile a strutturati forti	Suitable for Conforme	Suitable for Conforme	Not applicable to "strong" structures Non applicabile a strutturati forti
		e.c. ± 0,8 Non-rect. e.c. ± 0,6 Rect.	e.c. ± 0,5 Non-rect. e.c. ± 0,4 Rect.	e.c. ± 2,0 Non-rect. e.c. ± 1,8 Rect.					
		w. ± 0,8 Non-rect. w. ± 0,6 Rect.	w. ± 0,5 Non-rect. w. ± 0,4 Rect.	w. ± 2,0 Non-rect. w. ± 1,8 Rect.					
Structural characteristics	Water absorption (in % by mass) Massa d'acqua assorbita (come % della massa)	ISO 10545-3	E _s ≤ 0,5% Individual max 0,6% E _v ≤ 0,5% Valore max singolo 0,6%		≤ 0,1 %	≤ 0,1 %	≤ 0,1 %	≤ 0,1 %	≤ 0,1 %
		ASTM C373-18	Requirement ANSI A137.1 Water Absorption Max ≤ 0,5%		≤ 0,5 %	≤ 0,5 %	≤ 0,5 %	≤ 0,5 %	≤ 0,5 %
Bulk mechanical characteristics	Breaking strength Sforzo di rottura	ISO 10545-4	S ≥ 700N (for thickness < 7,5 mm - per spessore < 7,5 mm) S ≥ 1300N (for thickness ≥ 7,5 mm - per spessore ≥ 7,5 mm)		S ≥ 1500 N	S ≥ 10000 N	S ≥ 1500 N	S ≥ 1500 N	S ≥ 1500 N
	Modulus of rupture Resistenza alla flessione	ISO 10545-4	R ≥ 35 N/mm ²		R ≥ 40 N/mm ²	R ≥ 45 N/mm ²	R ≥ 40 N/mm ²	R ≥ 40 N/mm ²	R ≥ 40 N/mm ²
	Bending strength and breaking load Resistenza a flessione e al carico di rottura (4)(5)	EN 1339 Annex F	-		-	≥ T11 60x60	≥ U4 45x90	-	-
	Impact resistance, as coefficient of restitution Resistenza all'impatto, espresso come coefficiente di restituzione	ISO 10545-5	Declared value Valore dichiarato		≥ 0,55	≥ 0,55	≥ 0,55	≥ 0,55	≥ 0,55
Surface mechanical characteristics	Mohs hardness Durezza Mohs	EN 101	-		7	8	5	6	8
	Resistance to deep abrasion of unglazed tiles (removed volume) Resistenza all'abrasione profonda delle piastrelle non smaltate (volume materiale asportato)	ISO 10545-6	≤ 175 mm ³		≤ 150 mm ³	≤ 150 mm ³	≤ 150 mm ³	≤ 150 mm ³	≤ 150 mm ³
Thermal and hygrometric characteristics	Coefficient of thermal linear expansion Coefficiente di dilatazione termica lineare	ISO 10545-8	Declared value Valore dichiarato		≤ 7 MK ⁻¹	≤ 7 MK ⁻¹	≤ 7 MK ⁻¹	≤ 7 MK ⁻¹	≤ 7 MK ⁻¹
	Thermal shock resistance Resistenza agli sbalzi termici	ISO 10545-9	Pass according to EN ISO 10545-1 Test superato in accordo con ISO 10545-1		Resistant Resiste	Resistant Resiste	Resistant Resiste	Resistant Resiste	Resistant Resiste
	Moisture expansion (in mm/m) Dilatazione all'umidità (in mm/m)	ISO 10545-10	Declared value Valore dichiarato		≤ 0,01% (0,1mm/m)	≤ 0,01% (0,1mm/m)	≤ 0,01% (0,1mm/m)	≤ 0,01% (0,1mm/m)	≤ 0,01% (0,1mm/m)
	Frost resistance Resistenza al gelo	ISO 10545-12	Pass according to EN ISO 10545-1 Test superato in accordo con ISO 10545-1		Resistant Resiste	Resistant Resiste	Resistant Resiste	Resistant Resiste	Resistant Resiste
Physical properties	Bond strength/adhesion for improved cementitious adhesives Adesione a trazione con adesivi cementizi migliorati	EN 1348	Declared value Valore dichiarato		≥ 1,0 N/mm ² (Class C2 - EN 12004)	≥ 1,0 N/mm ² (Class C2 - EN 12004)	≥ 1,0 N/ mm ² (Class C2 - EN 12004)	≥ 1,0 N/ mm ² (Class C2 - EN 12004)	≥ 1,0 N/mm ² (Class C2 - EN 12004)
	Reaction to fire Reazione al fuoco	-	Class A1 or A1 Classe A1 oppure A1 _{fl}		A1 - A1 _{fl}	A1 - A1 _{fl}	A1 - A1 _{fl}	A1 - A1 _{fl}	A1 - A1 _{fl}
Chemical characteristics	Resistance to household chemicals and swimming pool salts Resistenza ai prodotti chimici di uso domestico ed agli additivi per piscina	ISO 10545-13	Minimum Class B Classe minima B		A	A	A	A	A
	Resistance to low concentrations of acids and alkalis Resistenza a basse concentrazioni di acidi e alcali		Declared Class Classe dichiarata		LA	LA	LA	LA	LA
	Resistance to high concentrations of acids and alkalis Resistenza ad alte concentrazioni di acidi e alcali	Declared Class Classe dichiarata		HA	HA	-	HA	HA	-
Safety characteristics (1)(2)	Resistance to staining, for unglazed tiles Resistenza alle macchie per piastrelle non smaltate	ISO 10545-14	Declared Class Classe dichiarata		5	5	5	5	5
	Shod Ramp Test Metodo della rampa "calzato"	DIN 51130	Declared value Valore dichiarato		R11	R11	N.C.	R10	R11
	Barefoot Ramp Test Metodo della rampa a piedi nudi	DIN 51097	Declared value Valore dichiarato		A+B	A+B+C	0	A	A+B+C
	Pendulum Friction Test Metodo del Pendolo	BS 7976	PTV ≥ 36 classifies the surface as "low slip risk"		≥ 36 Dry ≥ 36 Wet	≥ 36 Dry ≥ 36 Wet	≥ 36 Dry ≤ 24 Wet	≥ 36 Dry ≥ 36 Wet	≥ 36 Dry ≥ 36 Wet
		AS 4586	Declared Classification of the new pedestrian surface materials according to the Pendulum Test		Class P4	Class P4	-	Class P3	Class P4
		UNE-ENV 12633	Declared value Valore dichiarato		Class C3	Class C3	-	(●●●)	Class C3
Coefficient of friction (COF) Coefficiente di attrito	B.C.R.A. Rep. CEC/81	D. M. 236/89 del 14/06/89 μ > 0,40 per elemento scivolante cuoio su pavimentazione asciutta μ > 0,40 per elemento scivolante gomma dura su pavimentazione bagnata		> 0,40 Asciutto > 0,40 Bagnato	> 0,40 Asciutto > 0,40 Bagnato	> 0,40 Asciutto < 0,40 Bagnato	> 0,40 Asciutto > 0,40 Bagnato	> 0,40 Asciutto > 0,40 Bagnato	
Dynamic coefficient of friction (DCOF) Coefficiente di attrito dinamico	ANSI A137.1	ANSI A.137.1-2017 Requires a minimum value of 0.42 for level interior space expected to be walked upon when wet. (3)		> 0,42 Wet	> 0,42 Wet	< 0,42 Wet	> 0,42 Wet	> 0,42 Wet	

MARK	MARVEL				MARVEL GEMS		MARVEL DREAM				MARVEL EDGE			MARVEL PRO		
	Outdoor ✱ 20mm	Matte ✱ 6mm	Polished ✱ 6mm	Polished ✱ 6mm	Matte	Polished 60x60 cm	Matte 60x60 cm	Matte ✱ 6mm	Polished ✱ 6mm	Polished ✱ 6mm	Matte	Polished ✱ 6mm	Polished	Matte	Matte ✱ 6mm	Polished
Suitable for Conforme	Suitable for Conforme	Suitable for Conforme	Suitable for Conforme	Suitable for Conforme	Suitable for Conforme	Suitable for Conforme	Suitable for Conforme	Suitable for Conforme	Suitable for Conforme	Suitable for Conforme	Suitable for Conforme	Suitable for Conforme	Suitable for Conforme	Suitable for Conforme	Suitable for Conforme	Suitable for Conforme
Suitable for Conforme	Suitable for Conforme	Suitable for Conforme	Suitable for Conforme	Suitable for Conforme	Suitable for Conforme	Suitable for Conforme	Suitable for Conforme	Suitable for Conforme	Suitable for Conforme	Suitable for Conforme	Suitable for Conforme	Suitable for Conforme	Suitable for Conforme	Suitable for Conforme	Suitable for Conforme	Suitable for Conforme
Suitable for Conforme	Suitable for Conforme	Suitable for Conforme	Suitable for Conforme	Suitable for Conforme	Suitable for Conforme	Suitable for Conforme	Suitable for Conforme	Suitable for Conforme	Suitable for Conforme	Suitable for Conforme	Suitable for Conforme	Suitable for Conforme	Suitable for Conforme	Suitable for Conforme	Suitable for Conforme	Suitable for Conforme
Suitable for Conforme	Suitable for Conforme	Suitable for Conforme	Suitable for Conforme	Suitable for Conforme	Suitable for Conforme	Suitable for Conforme	Suitable for Conforme	Suitable for Conforme	Suitable for Conforme	Suitable for Conforme	Suitable for Conforme	Suitable for Conforme	Suitable for Conforme	Suitable for Conforme	Suitable for Conforme	Suitable for Conforme
Not applicable to "strong" structures Non applicabile a strutturati forti	Suitable for Conforme	Suitable for Conforme	Suitable for Conforme	Suitable for Conforme	Suitable for Conforme	Suitable for Conforme	Suitable for Conforme	Suitable for Conforme	Suitable for Conforme	Suitable for Conforme	Suitable for Conforme	Suitable for Conforme	Suitable for Conforme	Suitable for Conforme	Suitable for Conforme	Suitable for Conforme
≤ 0,1 %	≤ 0,1 %	≤ 0,1 %	≤ 0,1 %	≤ 0,1 %	≤ 0,1 %	≤ 0,1 %	≤ 0,1 %	≤ 0,1 %	≤ 0,1 %	≤ 0,1 %	≤ 0,1 %	≤ 0,1 %	≤ 0,1 %	≤ 0,1 %	≤ 0,1 %	≤ 0,1 %
≤ 0,5 %	≤ 0,5 %	≤ 0,5 %	≤ 0,5 %	≤ 0,5 %	≤ 0,5 %	≤ 0,5 %	≤ 0,5 %	≤ 0,5 %	≤ 0,5 %	≤ 0,5 %	≤ 0,5 %	≤ 0,5 %	≤ 0,5 %	≤ 0,5 %	≤ 0,5 %	≤ 0,5 %
S ≥ 10000 N	S ≥ 1500 N	S ≥ 1000 N	S ≥ 1500 N	S ≥ 1000 N	S ≥ 1500 N	S ≥ 1500 N	S ≥ 1500 N	S ≥ 1000 N	S ≥ 1500 N	S ≥ 1000 N	S ≥ 1500 N	S ≥ 1000 N	S ≥ 1500 N	S ≥ 1000 N	S ≥ 1500 N	S ≥ 1500 N
R ≥ 45 N/mm ²	R ≥ 40 N/mm ²	R ≥ 40 N/mm ²	R ≥ 40 N/mm ²	R ≥ 40 N/mm ²	R ≥ 40 N/mm ²	R ≥ 40 N/mm ²	R ≥ 40 N/mm ²	R ≥ 40 N/mm ²	R ≥ 40 N/mm ²	R ≥ 40 N/mm ²	R ≥ 40 N/mm ²	R ≥ 40 N/mm ²	R ≥ 40 N/mm ²	R ≥ 40 N/mm ²	R ≥ 40 N/mm ²	R ≥ 40 N/mm ²
≥ T11 60x60	-	-	-	-	-	-	-	-	-	-	-	-	-	-	-	-
≥ 0,55	≥ 0,55	≥ 0,55	≥ 0,55	≥ 0,55	≥ 0,55	≥ 0,55	≥ 0,55	≥ 0,55	≥ 0,55	≥ 0,55	≥ 0,55	≥ 0,55	≥ 0,55	≥ 0,55	≥ 0,55	≥ 0,55
8	6	6	5	5	6	5	6	6	5	5	6	5	5	6	6	5
≤ 150 mm ³	≤ 150 mm ³	≤ 150 mm ³	≤ 150 mm ³	≤ 150 mm ³	≤ 150 mm ³	≤ 150 mm ³	≤ 150 mm ³	≤ 150 mm ³	≤ 150 mm ³	≤ 150 mm ³	≤ 150 mm ³	≤ 150 mm ³	≤ 150 mm ³	≤ 150 mm ³	≤ 150 mm ³	≤ 150 mm ³
≤ 7 MK ⁻¹	≤ 7 MK ⁻¹	≤ 7 MK ⁻¹	≤ 7 MK ⁻¹	≤ 7 MK ⁻¹	≤ 7 MK ⁻¹	≤ 7 MK ⁻¹	≤ 7 MK ⁻¹	≤ 7 MK ⁻¹	≤ 7 MK ⁻¹	≤ 7 MK ⁻¹	≤ 7 MK ⁻¹	≤ 7 MK ⁻¹	≤ 7 MK ⁻¹	≤ 7 MK ⁻¹	≤ 7 MK ⁻¹	≤ 7 MK ⁻¹
Resistant Resiste	Resistant Resiste	Resistant Resiste	Resistant Resiste	Resistant Resiste	Resistant Resiste	Resistant Resiste	Resistant Resiste	Resistant Resiste	Resistant Resiste	Resistant Resiste	Resistant Resiste	Resistant Resiste	Resistant Resiste	Resistant Resiste	Resistant Resiste	Resistant Resiste
≤ 0,01% (0,1mm/m)	≤ 0,01% (0,1mm/m)	≤ 0,01% (0,1mm/m)	≤ 0,01% (0,1mm/m)	≤ 0,01% (0,1mm/m)	≤ 0,01% (0,1mm/m)	≤ 0,01% (0,1mm/m)	≤ 0,01% (0,1mm/m)	≤ 0,01% (0,1mm/m)	≤ 0,01% (0,1mm/m)	≤ 0,01% (0,1mm/m)	≤ 0,01% (0,1mm/m)	≤ 0,01% (0,1mm/m)	≤ 0,01% (0,1mm/m)	≤ 0,01% (0,1mm/m)	≤ 0,01% (0,1mm/m)	≤ 0,01% (0,1mm/m)
Resistant Resiste	Resistant Resiste	Resistant Resiste	Resistant Resiste	Resistant Resiste	Resistant Resiste	Resistant Resiste	Resistant Resiste	Resistant Resiste	Resistant Resiste	Resistant Resiste	Resistant Resiste	Resistant Resiste	Resistant Resiste	Resistant Resiste	Resistant Resiste	Resistant Resiste
≥ 1,0 N/mm ² (Class C2 - EN 12004)	≥ 1,0 N/ mm ² (Class C2 - EN 12004)	≥ 1,0 N/ mm ² (Class C2 - EN 12004)	≥ 1,0 N/ mm ² (Class C2 - EN 12004)	≥ 1,0 N/ mm ² (Class C2 - EN 12004)	≥ 1,0 N/ mm ² (Class C2 - EN 12004)	≥ 1,0 N/ mm ² (Class C2 - EN 12004)	≥ 1,0 N/ mm ² (Class C2 - EN 12004)	≥ 1,0 N/mm ² (Class C2 - EN 12004)	≥ 1,0 N/mm ² (Class C2 - EN 12004)	≥ 1,0 N/mm ² (Class C2 - EN 12004)	≥ 1,0 N/mm ² (Class C2 - EN 12004)	≥ 1,0 N/mm ² (Class C2 - EN 12004)	≥ 1,0 N/mm ² (Class C2 - EN 12004)	≥ 1,0 N/mm ² (Class C2 - EN 12004)	≥ 1,0 N/mm ² (Class C2 - EN 12004)	≥ 1,0 N/mm ² (Class C2 - EN 12004)
A1 - A1 _{fl}	A1 - A1 _{fl}	A1 - A1 _{fl}	A1 - A1 _{fl}	A1 - A1 _{fl}	A1 - A1 _{fl}	A1 - A1 _{fl}	A1 - A1 _{fl}	A1 - A1 _{fl}	A1 - A1 _{fl}	A1 - A1 _{fl}	A1 - A1 _{fl}	A1 - A1 _{fl}	A1 - A1 _{fl}	A1 - A1 _{fl}	A1 - A1 _{fl}	A1 - A1 _{fl}
A	A	A	A	A	A	A	A	A	A	A	A	A	A	A	A	A
LA	LA	LA	LA	LA	LA	LA	LA	LA	LA	LA	LA	LA	LA	LA	LA	LA
HA	HA	HA	-	-	HA	-	HA	HA	HA	-	-	HA	-	-	HA	HA
5	5	5	5	5	5	5	5	5	5	5	5	5	5	5	5	5
R11	R9	R9	N.C.	N.C.	R10	N.C.	R10	R9	R9	N.C.	N.C.	R9	N.C.	N.C.	R9	R9
A+B+C	A	A	0	0	A	0	A+B	A	A	0	0	A	0	0	A	A
≥ 36 Dry ≥ 36 Wet	(●)	(●)	≥ 36 Dry ≤ 24 Wet	≥ 36 Dry ≤ 24 Wet	≥ 36 Dry ≥ 36 Wet	≥ 36 Dry ≤ 24 Wet	≥ 36 Dry ≥ 36 Wet	≥ 36 Dry ≤ 24 Wet	(●)	(●)	≥ 36 Dry ≤ 24 Wet	≥ 36 Dry ≤ 24 Wet	(●)	≥ 36 Dry ≤ 24 Wet	≥ 36 Dry ≤ 24 Wet	(●)
Class P4	(●●)	(●●)	-	-	Class P3	-	Class P3	(●●)	(●●)	-	-	(●●)	-	-	(●●)	(●●)
Class C3	(●●●)	(●●●)	-	-	(●●●)	-	Class C2	(●●●)	(●●●)	-	-	(●●●)	-	-	(●●●)	(●●●)
> 0,40 Asciutto > 0,40 Bagnato	> 0,40 Asciutto > 0,40 Bagnato	> 0,40 Asciutto > 0,40 Bagnato	> 0,40 Asciutto < 0,40 Bagnato	> 0,40 Asciutto < 0,40 Bagnato	> 0,40 Asciutto > 0,40 Bagnato	> 0,40 Asciutto > 0,40 Bagnato	> 0,40 Asciutto > 0,40 Bagnato	> 0,40 Asciutto > 0,40 Bagnato	> 0,40 Asciutto > 0,40 Bagnato	> 0,40 Asciutto < 0,40 Bagnato	> 0,40 Asciutto > 0,40 Bagnato	> 0,40 Asciutto > 0,40 Bagnato	> 0,40 Asciutto > 0,40 Bagnato	> 0,40 Asciutto > 0,40 Bagnato	> 0,40 Asciutto > 0,40 Bagnato	> 0,40 Asciutto > 0,40 Bagnato
> 0,42 Wet	> 0,42 Wet	> 0,42 Wet	< 0,42 Wet	< 0,42 Wet	> 0,42 Wet	> 0,42 Wet	> 0,42 Wet	> 0,42 Wet	> 0,42 Wet	< 0,42 Wet	< 0,42 Wet	< 0,42 Wet	> 0,42 Wet	< 0,42 Wet	< 0,42 Wet	> 0,42 Wet

			Requirements for nominal size N Requisiti per dimensione nominale N			ROOM	SEASTONE			
			7 cm ≤ N < 15 cm (mm)	N ≥ 15 cm (%)			Matte	Matte	Textured	Outdoor ☒20mm
Regularity characteristics		Length and width Lunghezza e larghezza	± 0,9 (*) Non-rect. ± 0,4 (*) Rect.	± 0,6 (*) Non-rect. ± 0,3 (*) Rect.	± 2,0 (*) Non-rect. ± 1,0 (*) Rect.	Suitable for Conforme	Suitable for Conforme	Suitable for Conforme	Suitable for Conforme	
		Thickness Spessore	± 0,5 (**)	± 5 (**)	± 0,5 (**)	Suitable for Conforme	Suitable for Conforme	Suitable for Conforme	Suitable for Conforme	
		Straightness of sides Rettilinearità degli spigoli	± 0,8 (***) Non-rect. ± 0,4 (***) Rect.	± 0,5 (***) Non-rect. ± 0,3 (***) Rect.	± 1,5 (***) Non-rect. ± 0,8 (***) Rect.	Suitable for Conforme	Suitable for Conforme	Suitable for Conforme	Suitable for Conforme	
		Rectangularity (Measurement only on short edges when L/I ≥ 3) Ortogonalità (Misurazione da condurre solo sui lati corti quando L/I ≥ 3)	± 0,8 (****) Non-rect. ± 0,4 (****) Rect.	± 0,5 (****) Non-rect. ± 0,3 (****) Rect.	± 2,0 (****) Non-rect. ± 1,5 (****) Rect.	Suitable for Conforme	Suitable for Conforme	Suitable for Conforme	Suitable for Conforme	
Structural characteristics		Water absorption (in % by mass) Massa d'acqua assorbita (come % della massa)	ISO 10545-3	E _v ≤ 0,5% Individual max 0,6% E _v ≤ 0,5% Valore max singolo 0,6%			≤ 0,1 %	≤ 0,1 %	≤ 0,1 %	≤ 0,1 %
			ASTM C373-18	Requirement ANSI A137.1 Water Absorption Max ≤ 0,5%			≤ 0,5 %	≤ 0,5 %	≤ 0,5 %	≤ 0,5 %
Bulk mechanical characteristics		Breaking strength Sforzo di rottura	ISO 10545-4	S ≥ 700N (for thickness < 7,5 mm - per spessore < 7,5 mm) S ≥ 1300N (for thickness ≥ 7,5 mm - per spessore ≥ 7,5 mm)			S ≥ 1500 N	S ≥ 1500 N	S ≥ 1500 N	S ≥ 10000 N
		Modulus of rupture Resistenza alla flessione		R ≥ 35 N/mm ²	R ≥ 40 N/mm ²	R ≥ 40 N/mm ²	R ≥ 40 N/mm ²	R ≥ 45 N/mm ²		
		Bending strength and breaking load Resistenza a flessione e al carico di rottura (4/5)	EN 1339 Annex F	-	-	-	≥ T11 60x60			
		Impact resistance, as coefficient of restitution Resistenza all'impatto, espresso come coefficiente di restituzione	ISO 10545-5	Declared value Valore dichiarato	≥ 0,55	≥ 0,55	≥ 0,55	≥ 0,55		
Surface mechanical characteristics		Mohs hardness Durezza Mohs	EN 101	-	6	6	8	8		
		Resistance to deep abrasion of unglazed tiles (removed volume) Resistenza all'abrasione profonda delle piastrelle non smaltate (volume materiale asportato)	ISO 10545-6	≤ 175 mm ³	≤ 150 mm ³	≤ 150 mm ³	≤ 150 mm ³	≤ 150 mm ³		
Thermal and hygrometric characteristics		Coefficient of thermal linear expansion Coefficiente di dilatazione termica lineare	ISO 10545-8	Declared value Valore dichiarato	≤ 7 MK ⁻¹	≤ 7 MK ⁻¹	≤ 7 MK ⁻¹	≤ 7 MK ⁻¹		
		Thermal shock resistance Resistenza agli sbalzi termici	ISO 10545-9	Pass according to EN ISO 10545-1 Test superato in accordo con ISO 10545-1	Resistant Resiste	Resistant Resiste	Resistant Resiste	Resistant Resiste		
		Moisture expansion (in mm/m) Dilatazione all'umidità (in mm/m)	ISO 10545-10	Declared value Valore dichiarato	≤ 0,01% (0,1mm/m)	≤ 0,01% (0,1mm/m)	≤ 0,01% (0,1mm/m)	≤ 0,01% (0,1mm/m)		
		Frost resistance Resistenza al gelo	ISO 10545-12	Pass according to EN ISO 10545-1 Test superato in accordo con ISO 10545-1	Resistant Resiste	Resistant Resiste	Resistant Resiste	Resistant Resiste		
Physical properties		Bond strength/adhesion for improved cementitious adhesives Adesione a trazione con adesivi cementizi migliorati	EN 1348	Declared value Valore dichiarato	≥ 1,0 N/ mm ² (Class C2 - EN 12004)	≥ 1,0 N/ mm ² (Class C2 - EN 12004)	≥ 1,0 N/mm ² (Class C2 - EN 12004)	≥ 1,0 N/mm ² (Class C2 - EN 12004)		
		Reaction to fire Reazione al fuoco	-	Class A1 or A1 Classe A1 oppure A1 _s	A1 - A1 _s	A1 - A1 _s	A1 - A1 _s	A1 - A1 _s		
Chemical characteristics		Resistance to household chemicals and swimming pool salts Resistenza ai prodotti chimici di uso domestico ed agli additivi per piscina	ISO 10545-13	Minimum Class B Classe minima B	A	A	A	A		
		Resistance to low concentrations of acids and alkalis Resistenza a basse concentrazioni di acidi e alcali		Declared Class Classe dichiarata	LA	LA	LA	LA		
		Resistance to high concentrations of acids and alkalis Resistenza ad alte concentrazioni di acidi e alcali		Declared Class Classe dichiarata	HA	HA	HA	HA		
Safety characteristics (1)(2)		Resistance to staining, for unglazed tiles Resistenza alle macchie per piastrelle non smaltate	ISO 10545-14	Declared Class Classe dichiarata	5	5	5	5		
		Shod Ramp Test Metodo della rampa "calzato"	DIN 51130	Declared value Valore dichiarato	R10	R9	R11	R11		
		Barefoot Ramp Test Metodo della rampa a piedi nudi	DIN 51097	Declared value Valore dichiarato	A	A	A+B+C	A+B+C		
		Pendulum Friction Test Metodo del Pendolo	BS 7976	PTV ≥ 36 classifies the surface as "low slip risk"	☉	☉	≥ 36 Dry ≥ 36 Wet	≥ 36 Dry ≥ 36 Wet		
			AS 4586	Declared Classification of the new pedestrian surface materials according to the Pendulum Test	Class P3	☉☉	Class P4	Class P4		
			UNE-ENV 12633	Declared value Valore dichiarato	☉☉☉	☉☉☉	Class C3	Class C3		
		Coefficient of friction (COF) Coefficiente di attrito	B.C.R.A. Rep. CEC/81	D. M. 236/89 del 14/06/89 μ > 0,40 per elemento scivolante cuoio su pavimentazione asciutta μ > 0,40 per elemento scivolante gomma dura su pavimentazione bagnata	> 0,40 Asciutto > 0,40 Bagnato	> 0,40 Asciutto > 0,40 Bagnato	> 0,40 Asciutto > 0,40 Bagnato	> 0,40 Asciutto > 0,40 Bagnato		
Dynamic coefficient of friction (DCOF) Coefficiente di attrito dinamico	ANSI A137.1	ANSI A.137.1-2017 Requires a minimum value of 0.42 for level interior space expected to be walked upon when wet. (3)	> 0,42 Wet	> 0,42 Wet	> 0,42 Wet	> 0,42 Wet				

SUNROCK	TRUST		
Outdoor ☒20mm	Matte	Grip	Outdoor ☒20mm *
Suitable for Conforme	Suitable for Conforme	Suitable for Conforme	Suitable for Conforme
Suitable for Conforme	Suitable for Conforme	Suitable for Conforme	Suitable for Conforme
Suitable for Conforme	Suitable for Conforme	Suitable for Conforme	Suitable for Conforme
Suitable for Conforme	Suitable for Conforme	Suitable for Conforme	Suitable for Conforme
Suitable for Conforme	Suitable for Conforme	Suitable for Conforme	Suitable for Conforme
Suitable for Conforme	Not applicable to "strong" structures Non applicabile a strutturati forti		
≤ 0,1 %	≤ 0,1 %	≤ 0,1 %	≤ 0,1 %
≤ 0,5 %	≤ 0,5 %	≤ 0,5 %	≤ 0,5 %
S ≥ 10000 N	S ≥ 1500 N	S ≥ 1500 N	S ≥ 10000 N
R ≥ 45 N/mm ²	R ≥ 40 N/mm ²	R ≥ 40 N/mm ²	R ≥ 45 N/mm ²
≥ T11 60x60	-	-	≥ U7 30x60 ≥ T11 60x60 ≥ U4 45x90 60x120
≥ 0,55	≥ 0,55	≥ 0,55	≥ 0,55
8	7	8	8
≤ 150 mm ³	≤ 150 mm ³	≤ 150 mm ³	≤ 150 mm ³
≤ 7 MK ⁻¹	≤ 7 MK ⁻¹	≤ 7 MK ⁻¹	≤ 7 MK ⁻¹
Resistant Resiste	Resistant Resiste	Resistant Resiste	Resistant Resiste
≤ 0,01% (0,1mm/m)	≤ 0,01% (0,1mm/m)	≤ 0,01% (0,1mm/m)	≤ 0,01% (0,1mm/m)
Resistant Resiste	Resistant Resiste	Resistant Resiste	Resistant Resiste
≥ 1,0 N/mm ² (Class C2 - EN 12004)	≥ 1,0 N/ mm ² (Class C2 - EN 12004)	≥ 1,0 N/ mm ² (Class C2 - EN 12004)	≥ 1,0 N/mm ² (Class C2 - EN 12004)
A1 - A1 _s	A1 - A1 _s	A1 - A1 _s	A1 - A1 _s
A	A	A	A
LA	LA	LA	LA
HA	HA	HA	HA
5	5	5	5
R11	R10	R12	R11
A+B+C	A+B	A+B+C	A+B+C
≥ 36 Dry ≥ 36 Wet	≥ 36 Dry ≥ 36 Wet	≥ 36 Dry ≥ 36 Wet	≥ 36 Dry ≥ 36 Wet
Class P4	Class P3	Class P4	Class P4
Class C3	Class C2	Class C3	Class C3
> 0,40 Asciutto > 0,40 Bagnato	> 0,40 Asciutto > 0,40 Bagnato	> 0,40 Asciutto > 0,40 Bagnato	> 0,40 Asciutto > 0,40 Bagnato
> 0,42 Wet	> 0,42 Wet	> 0,42 Wet	> 0,42 Wet

GLAZED PORCELAIN TILES GRES PORCELLANATO SMALTATO		GREEN COLORS		
		Matte	Grip	
Regularity characteristics		ISO 10545-2	Suitable for Conforme	
			Suitable for Conforme	
			Suitable for Conforme	
			Suitable for Conforme	
Structural characteristics		ISO 10545-3	≤ 0,5 %	
		ASTM C 373	≤ 0,5 %	
Bulk mechanical characteristics		ISO 10545-4	S ≥ 1000 N	
			R ≥ 40 N/mm ²	
		ISO 10545-5	≥ 0,55	
Surface mechanical characteristics		EN 101	5 7	
		PEI	ISO 10545-7	View the collection Guarda la collezione
Thermal and hygrometric characteristics		ISO 10545-8	≤ 7 MK ⁻¹	
		ISO 10545-9	Resistant Resiste	
		ISO 10545-10	≤ 0,01% (0,1mm/m)	
		ISO 10545-11	Resistant Resiste	
		ISO 10545-12	Resistant Resiste	
Physical properties		EN 1348	≥ 1,0 N/mm ² (Class C2 - EN 12004)	
		-	A1 - A1 _s	
Chemical characteristics		ISO 10545-13	A LA HA	
		ISO 10545-14	5	
		DIN 51130	N.C.	R10
Safety characteristics (1)(2)		DIN 51097	0	A+B
		BS 7976	≥ 36 Dry ≥ 24 Wet	≥ 36 Dry ≥ 36 Wet
		AS 4586	-	☉☉
		UNE-ENV 12633	-	☉☉☉
		B.C.R.A. Rep. CEC/81	> 0,40 Asciutto < 0,40 Bagnato	> 0,40 Asciutto > 0,40 Bagnato
		ANSI A137.1	< 0,42 Wet	> 0,42 Wet



COLOURED BODY PORCELAIN TILES - NON RECTIFIED
GRES PORCELLANATO COLORATO IN MASSA - NON RETTIFICATO
Grès cérame coloré dans la masse - Non rectifié
Durchgefärbtes Feinsteinzeug - Nicht rektifiziert
Gres porcelánico coloreado en masa - No rectificada
Керамический гранит окрашенный в массе - Нереттифицированные

		Requirements for nominal size N Requisiti per dimensione nominale N		162x324 cm - 63 ³ / ₄ "x127 ¹ / ₂ " Non Rectified			
		N ≥ 15 cm		Silk	Matte	Lappato Lux	
		(%)	(mm)				
Regularity characteristics	Thickness Spessore	ISO 10545-2	± 5 (**)	± 0,5 (**)	± 5,0% ± 0,5 mm		
	Surface flatness Planarità		c.c. ± 0,5	c.c. ± 2,0	± 0,5% ± 2,0 mm		
			e.c. ± 0,5	e.c. ± 2,0			
			w. ± 0,5	w. ± 2,0			
			EN 144TI annex e; (Group Bla) EN 74477 appendice G (Gruppo Bla)	ISO 13006 annex e; (Group Bla) 150 73006 appendice G (Gruppo Bla)			
Structural characteristics	Water absorption Massa d'acqua assorbita	ISO 10545-3	E _s ≤ 0,5% Individual max 0,6% E _s ≤ 0,5% Valore max singolo 0,6%		≤ 0,1 %		
		ASTM C373	Requirement ANSI A137.1 Water Absorption Max ≤ 0,5%		≤ 0,5 %		
Bulk mechanical characteristics	Breaking strength Sforzo di rottura	ISO 10545-4	S ≥ 700 N for thickness < 7,5mm per spessore < 7,5mm	S ≥ 1300 N for thickness ≥ 7,5mm per spessore ≥ 7,5mm	6 mm -> S ≥ 1000N		
	Modulus of rupture Resistenza alla flessione		R ≥ 35 N/mm ²		R ≥ 45 N/mm ²		
Surface mechanical characteristics	Mohs hardness Durezza Mohs	EN 101	-		6	6 4÷5	
	Resistance to deep abrasion of unglazed tiles (removed volume) Resistenza all'abrasione profonda delle piastrelle non smaltate (volume materiale asportato)	ISO 10545-6	≤ 175 mm ³		≤ 160 mm ³		
Thermal and hygrometric characteristics	Coefficient of thermal linear expansion Coefficiente di dilatazione termica lineare	ISO 10545-8	Declared value Valore dichiarato	Test method available Metodo di prova disponibile	≤ 9 M°C ⁻¹		
	Thermal shock resistance Resistenza agli sbalzi termici	ISO 10545-9	Pass according to EN ISO 10545-1 Test superato in accordo con ISO 10545-1	Test method available Metodo di prova disponibile	Resistant Resiste		
	Moisture expansion (in mm/m) Dilatazione all'umidità (in mm/m)	ISO 10545-10	Declared value Valore dichiarato	Test method available Metodo di prova disponibile	≤ 0,01% (0,1mm/m)		
	Frost resistance Resistenza al gelo	ISO 10545-12	Pass according to EN ISO 10545-1 Test superato in accordo con ISO 10545-1	Required Metodo di prova richiesto	Resistant Resiste		
Physical properties	Bond strength/adhesion for improved cementitious adhesives Adesione a trazione con adesivi cementizi migliorati	EN 1348	Declared value Valore dichiarato	-	≥ 1,0 N/mm ² (Class C2 - EN 12004)		
	Reaction to fire Reazione al fuoco	-	Class A1 Classe A1	-	A1 (only ceramic tiles)		
Chemical characteristics	Resistance to household chemicals and swimming pool salts Resistenza ai prodotti chimici di uso domestico ed agli additivi per piscina	ISO 10545-13	Minimum Class B (U for unglazed tiles) Classe minima B (U per piastrelle non smaltate)		UA		
	Resistance to low concentrations of acids and alkalis Resistenza a basse concentrazioni di acidi e alcali		Declared Class Classe dichiarata	Manufacturer is to state classification Secondo la classificazione indicata dal fabbricante	ULA	ULA	ULC
	Resistance to high concentrations of acids and alkalis Resistenza ad alte concentrazioni di acidi e alcali		Declared Class Classe dichiarata	Test method available Metodo di prova disponibile	UHA	UHA	UHC
	Resistance to staining Resistenza alle macchie	ISO 10545-14	Declared Class Classe dichiarata	Test method available Metodo di prova disponibile	5		
	Release of dangerous substances: Cadmium (in mg/dm²) and Lead (in mg/dm²) Rilascio di sostanze pericolose: Cadmio (in mg/dm ²) e Piombo (in mg/dm ²)	ISO 10545-15	Declared value Valore dichiarato	Test method available Metodo di prova disponibile	≤ 0,01 mg/dm ² Cd ≤ 0,1 mg/dm ² Pb		
	Resistance to scratching Resistenza alla graffiatura	UNI EN 15186:2012 met.B			CEN/TS 16209 Class B CEN/TS 76209 Classe B		
	Tendency to retain dirt Tendenza a ritenere lo sporco	UNI 9300:2015			No visible change (5) Nessun cambiamento visibile (5)		
	Surface resistance to cold liquids Resistenza delle superfici ai liquidi freddi	UNI EN 12720:2013			CEN/TS 16209 Class A CEN/TS 16209 Classe A		
	Surface resistance to wet heat Resistenza delle superfici al calore umido	UNI EN 12721:2013			CEN/TS 16209 Class A CEN/TS 16209 Classe A		
	Surface resistance to dry heat Resistenza delle superfici al calore secco	UNI EN 12722:2013			CEN/TS 16209 Class A CEN/TS 16209 Classe A		
	Assessment of resistance to impact Resistenza all'urto	ISO 4211-4:1988			Class 4 (ST) Classe 4 (ST)		



ARBOR Porcelain tiles (15x90 cm)

ARKSHADE Porcelain tiles

AXI

BOOST Porcelain tiles

BRAVE Porcelain tiles

DWELL Porcelain tiles

ETIC

ETIC PRO

EVOLVE

GRANIOLIATI

MARK Porcelain tiles

MARVEL Porcelain tiles

MARVEL EDGE Porcelain tiles

MARVEL GEMS Porcelain tiles

MARVEL PRO Porcelain tiles

MARVEL STONE Porcelain tiles

NID Porcelain tiles (15x90 cm)

ROOM Porcelain tiles

SEASTONE

SUNROCK

TRUST



AXI

BRAVE Porcelain tiles

KONE Porcelain tiles

MARK Porcelain tiles

NID

SEASTONE

SUNROCK

TRUST

Classificazione UPEC - in via di certificazione / Classification UPEC - en cours de certification



MARVEL DREAM Porcelain tiles

RAW Porcelain tiles

BLAZE Porcelain tiles

DOLMEN PRO

AIX Porcelain tiles

Si consiglia la consultazione della pagina
<http://webapp.cstb.fr/upec-ceramique/index.php?view=TitulaireListeProduits&sid=39&tid=1>
Per ulteriori informazioni scrivere a france@atlasconcorde.it

On vous conseille de vous connecter à:
<http://webapp.cstb.fr/upec-ceramique/index.php?view=TitulaireListeProduits&sid=39&tid=1>
Pour tous renseignements complémentaires merci d'écrire à france@atlasconcorde.it

Destinations of use / Destinazione d'uso

PORCELAIN TILES / GRES PORCELLANATO

Grès cérame / Feinsteinzeug
Gres porcelánico / Керамогранит



HEAVY TRAFFIC
CALPESTIO PESANTE

HEAVY COMMERCIAL

Malls, airports, places of worship, schools, museums, squares, hospitals, hotels - foyers, undergrounds, train stations, etc.

COMMERCIALI PESANTI

Mall, aeroporti, luoghi di culto, scuole, musei, piazze, ospedali, hotel - hall di ingresso, metropolitane, stazioni ferroviarie, ecc...

COMMERCIALI PESANTI

Centres commerciaux, aéroports, lieux de culte, écoles, musées, places, hôpitaux, hôtels - halls d'entrée, stations de métro, gares, etc...

STARK BEANSPRUCHTE GEWERBEBEREICHE

Enkaufszentren, Flughäfen, Kultstätten, Schulen, Museen, Plätze, Krankenhäuser, Hotels - Eingangshallen, U-Bahn-Stationen, Bahnhöfe etc.

COMERCIALES PESADOS

Centros comerciales, aeropuertos, lugares de culto, colegios, museos, plazas, hospitales, hoteles - hall de entrada, metros, estaciones de trenes, etc. ...

ОБЩЕСТВЕННЫЕ ОБЪЕКТЫ С ВЫСОКОЙ ПОСЕЩАЕМОСТЬЮ

Торговые центры, аэропорты, церкви, школы, музеи, площади, больницы, входные холлы отелей, метро, вокзалы и т.п.



MEDIUM TRAFFIC
CALPESTIO MEDIO

MEDIUM COMMERCIAL

Restaurants, offices, shops, public restrooms, public offices, hotels except for foyers, business lounges, etc. with the exception of mandatory passageways and areas subject to the transit of trolleys with hard wheels or highly concentrated loads.

COMMERCIALI MEDI

Ristoranti, uffici, negozi, bagni pubblici, uffici pubblici, hotel - ad esclusione delle hall di ingresso, business lounge, etc. a esclusione di passaggi obbligati e zone soggetto a transito di carrelli con ruote dure ovvero elevati carichi concentrati.

BÂTIMENT COMMERCIAL MOYEN

Restaurants, bureaux, boutiques, sanitaires publics, bureaux publics, hôtels - à l'exception des halls d'entrée, business lounges, etc..., ainsi que des points de passage obligés et des zones soumises au passage de chariots à roues dures ou de charges ponctuelles lourdes.

GEWERBEBEREICHE MIT MITTLERER BEANSPRUCHUNG

Restaurants, Büros, Geschäfte, öffentliche Toiletten, öffentliche Ämter, Hotels mit Ausnahme der Eingangshallen, Business Lounges etc., unter Ausschluss obligatorischer Passagen sowie mit harten Rädern befahrener bzw. hohen, konzentrierten Lasten ausgesetzter Bereiche.

COMERCIALES MEDIOS

Restaurantes, oficinas, tiendas, baños públicos, oficinas públicas, hoteles - excluidos los pasillos de entradas, salas de negocios, etc. excluidos los pasos obligatorios y áreas sujetas al tránsito de carretillas con ruedas duras o cargas altamente concentradas.

ОБЩЕСТВЕННЫЕ ОБЪЕКТЫ СО СРЕДНЕЙ ПОСЕЩАЕМОСТЬЮ

Рестораны, офисы, магазины, общественные туалеты, общественные учреждения, отели (кроме входных холлов), бизнес-залы и т.п., за исключением общих проходов и мест, где предвидятся сосредоточенные нагрузки или перемещение тележек на жестких колесах.



LIGHT TRAFFIC
CALPESTIO LEGGERO

RESIDENTIAL

Bedrooms, living rooms, studies, private kitchens, private bathrooms, etc.

RESIDENZIALI

Camere da letto, soggiorni, studi, cucine private, bagni privati...

BÂTIMENT D'HABITATION

Chambres de nuit, salons, pièces à usage professionnel, cuisines, salles de bains...

WOHNUNGSBAU

Schlafzimmer, Wohnzimmer, Arbeitszimmer, private Küchen und Bäder...

RESIDENCIALES

Dormitorios, salones, salas de estar, cocinas particulares, cuartos de baño particulares...

ЖИЛЫЕ ПОМЕЩЕНИЯ

Спальни, гостиные, рабочие кабинеты, домашние кухни, домашние ванные комнаты и т.п.

RECOMMENDED PRODUCTS BY INTENDED USE / PRODOTTI CONSIGLIATI PER DESTINAZIONE D'USO

PRODUITS CONSEILLÉS PAR DESTINATION D'USAGE / EMPFOHLENE PRODUKTE NACH ZWECKBESTIMMUNG

PRODUCTOS ACONSEJADOS SEGÚN LOS USOS PREVISTOS / ИЗДЕЛИЯ, РЕКОМЕНДУЕМЫЕ В ЗАВИСИМОСТИ ОТ НАЗНАЧЕНИЯ

Heavy commercial, medium commercial and residential. Commerciale pesante, commerciale medio e residenziale.			H M L
ARBOR	matte/grip	± 8,5/9 mm	
ARKSHADE	matte/grip	± 9 mm	
AIX	matte/grip/textured	± 9/20 mm	
AXI	matte/textured	± 9,5/20 mm	
BLAZE	matte/grip/textured	± 9/20 mm	
BOOST	matte/grip/textured	± 9/20 mm	
BRAVE	matte/grip/textured	± 9/20 mm	
DOLMEN PRO	matte/grip/textured	± 9/20 mm	
DWELL	matte/textured	± 9/20 mm	
ETIC	matte/textured	± 9/9,5 mm	
ETIC PRO	matte/grip/textured	± 9/20 mm	
EVOLVE	matte	± 9 mm	
EXENCE	matte/grip/textured	± 9/20 mm	
GRANIOLIATI	matte/textured	± 7,6/8,6/12 mm	
GROUNDTRACK	matte	± 9 mm	
HEARTWOOD	matte	± 9 mm	
KLIF	matte/grip/textured	± 9/20 mm	
KONE	matte/grip/textured	± 9/20 mm	
MARK	matte/textured	± 9/20 mm	
MARVEL	matte	± 9 mm	
MARVEL DREAM	matte	± 9 mm	
MARVEL EDGE	matte	± 9 mm	
MARVEL GEMS	matte	± 9 mm	
MARVEL PRO	matte/textured	± 9/20 mm	
MARVEL STONE	matte	± 9 mm	
MEK	matte	± 9 mm	
NASH	matte/grip	± 8,5/9 mm	
NID	matte/textured	± 9/20 mm	
RAW	matte/grip/textured	± 9/20 mm	
ROOM	matte	± 9 mm	
SEASTONE	matte/textured	± 9/20 mm	
SUNROCK	textured	± 20 mm	
TRUST	matte/grip/textured	± 9/20/30 mm	

Medium commercial and residential. Commerciale medio e residenziale.			M L
ARKSHADE	polished *	± 9 mm	
BLAZE	matte/polished *	± 6/9 mm	
BOOST	matte	± 6 mm	
DWELL	polished *	± 9 mm	
KONE	matte/polished *	± 6/9 mm	
MARK	polished *	± 9 mm	
MARVEL	matte/polished *	± 6/9 mm	
MARVEL EDGE	polished *	± 6/9 mm	
MARVEL GEMS	polished *	± 9 mm	
MARVEL DREAM	matte/polished *	± 6/9 mm	
MARVEL PRO	matte/polished - satin *	± 6/9 mm	
MARVEL STONE	matte/polished *	± 6/9 mm	
RAW	matte	± 6 mm	

Residential. Residenziale.			L
GREENCOLORS	matte/grip	± 7,3 mm	

* The glossy polished finish is suitable for residential or low-traffic commercial floors, where no anti-slip performance is required, and for walls. If the product is in direct contact with the outdoors, provide devices for absorbing moisture and dirt to prevent scratches. / La finitura lappata lucida è indicata per pavimenti residenziali o commerciali poco sollecitati, laddove non siano richieste prestazioni antiscivolo, e per rivestimenti. Se il prodotto è a diretto contatto con l'esterno, prevedere dei dispositivi di assorbimento dell'umidità e della sporcizia per prevenire la formazione di graffi. / La finition polie brillante est indiquée pour les revêtements de murs, ainsi que pour les sols résidentiels ou commerciaux peu sollicités qui ne nécessitent pas de caractéristiques antiglisse. Si le produit est en contact direct avec l'extérieur, prévoir des dispositifs d'absorption de l'humidité et des salissures afin de prévenir la formation de rayures. / Das geläppte hochglanz-Finish eignet sich als Bodenbelag in nicht stark beanspruchten Wohn- oder Gewerberäumen, die keine Rutschfestigkeit erfordern, sowie als Wandbelag. Bei direktem Kontakt mit dem Außenbereich sind Mittel zur Aufnahme von Feuchtigkeit und Schmutz erforderlich, die das Produkt vor Verkratzung schützen. / El acabado Lapeado pulido está indicado para pisos residenciales o comerciales poco esforzados, donde no se requiera un rendimiento antideslizante, también es ideal para revestimientos. Si el producto está en contacto directo con el exterior, es necesario utilizar los dispositivos de absorción de la humedad y de la suciedad para evitar que se raye. / Лапатированная глянцевая плитка рекомендована для полов домашних и коммерческих интерьеров с небольшой интенсивностью эксплуатации и для стен. Если плитка находится в непосредственном контакте с наружной средой, необходимо предусмотреть устройства поглощения влаги и грязи во избежание образования царапин.

Porcelain tiles for outdoors / Gres porcellanato per esterni

PORCELAIN TILES / GRES PORCELLANATO

Grès cérame / Feinsteinzeug

Gres porcelánico / Керамогранит

INTENDED USES FOR OUTDOORS / DESTINAZIONE D'USO PER ESTERNI

Destination à usage extérieur / zweckbestimmungen für Aussenbereiche / uso previsto para exteriores / назначение для наружных пространств

INDUSTRIAL AND/OR COMMERCIAL AREAS FOR VEHICLES
Squares, public car parks, filling stations, paving for forklift trucks, pallet jacks, trailer trucks, buses, industrial platforms, etc.
INSTALLATION METHOD
Laying with adhesives using the "double buttering" method.
PRODUCT PORCELAIN TILES ⁽¹⁾
Porcelain tile with a thickness greater than or equal to 20 mm with anti-slip finish ⁽¹⁾.

AREE INDUSTRIALI E/O COMMERCIALI CARRABILI
Piazze, parcheggi pubblici, stazioni di rifornimento, pavimentazioni con transito di carrelli elevatori, transpallet, autoarticolati, autobus, piattaforme industriali, ecc...
TIPO DI POSA
Posa con adesivi con il metodo della "doppia spalmatura".
PRODOTTO GRES PORCELLANATO ⁽¹⁾
Gres porcellanato a spessore superiore o uguale a 20mm con finitura anti-scivolo ⁽¹⁾.

ZONES INDUSTRIELLES ET/OU ZONES COMMERCIALES AVEC PASSAGE DE VÉHICULES
Places, parkings publics, stations-services, sols avec passage de chariots élévateurs, transpalettes, véhicules articulés, autobus, plateformes industrielles, etc...
TYPE DE POSE
Pose à l'aide de colles par la méthode du "double encollage".
PRODUIT GRÈS CÉRAME ⁽¹⁾
Grès cérame d'épaisseur supérieure ou égale à 20 mm à finition anti-glisse⁽¹⁾.

BEFAHRBARE INDUSTRIE- UND/ODER GEWERBEFLÄCHEN
Plätze, öffentliche Parkplätze, Tankstellen, von Gabelstaplern, Handgabelhubwagen, Sattelschleppern, Bussen befahrene Böden, Industriplattformen etc.
VERLEGESYSTEM
Verlegung mit beidseitig aufgebrachtem Kleber (Buttering-Floating-Verfahren)
PRODUKT FEINSTEINZEUG ⁽¹⁾
Feinsteinzeug mit Stärke gleich oder über 20 mm und rutschfester Oberfläche⁽¹⁾.

ÁREAS INDUSTRIALES Y/O COMERCIALES TRAFICABLES
Centros comerciales, aeropuertos, lugares de culto, colegios, museos, plazas, hospitales, hoteles - hall de entrada, metros, estaciones de trenes, etc. ...
TIPO DE COLOCACIÓN
Colocación con materiales de agarre según el método de "doble encolado".
PRODUCTO GRES PORCELÁNICO ⁽¹⁾
Gres porcelánico de grosor mayor o igual a 20mm con acabado antideslizante⁽¹⁾.

ПРОМЫШЛЕННЫЕ И (ИЛИ) КОММЕРЧЕСКИЕ ПРОЕЗЖИЕ УЧАСТКИ
Площади, общественные парковки, заправочные станции, покрытия для проезда погрузчиков, гидравлических тележек, фур, автобусов, промышленные платформы и т.д.
ТИП УКЛАДКИ
Клеевая укладка с нанесением клея на монтажную сторону плитки и на облицовываемое основание
ИЗДЕЛИЕ КЕРАМОГРАНИТ ⁽¹⁾
Керамогранит толщиной 20 мм или больше с противоскользящей поверхностью⁽¹⁾.

RESIDENTIAL AREAS FOR VEHICLES
Outdoor courtyards, private homes, apartment complex parking lots (garages), etc. Pavements used only by cars.
INSTALLATION METHOD
Laying with adhesives using the "double buttering" method.
PRODUCT PORCELAIN TILES ⁽¹⁾
Porcelain tiles with anti-slip finish ⁽¹⁾.

AREE RESIDENZIALI CARRABILI
Cortili esterni abitazioni private, parcheggi condominiali (garage interni), ecc... Pavimentazioni a transito esclusivo di autovetture.
TIPO DI POSA
Posa con adesivi con il metodo della "doppia spalmatura".
PRODOTTO GRES PORCELLANATO ⁽¹⁾
Gres porcellanato con finitura anti-scivolo ⁽¹⁾.

ZONES RÉSIDENTIELLES AVEC PASSAGE DE VÉHICULES
Cours externes d'habitations individuelles, parkings d'immeuble (garages intérieurs), etc... Sols pour passage exclusivement de voitures.
TYPE DE POSE
Pose à l'aide de colles par la méthode du "double encollage".
PRODUIT GRÈS CÉRAME ⁽¹⁾
Grès cérame à finition anti-glisse ⁽¹⁾.

BEFAHRBARE BEREICHE IM WOHNUMGSAU
Außenhöfe und Parkplätze von Wohnhäusern, (Tiefgaragen) etc.
Ausschließlich von Pkws befahrene Bodenbeläge.
VERLEGESYSTEM
Verlegung mit beidseitig aufgebrachtem Kleber (Buttering-Floating-Verfahren)
PRODUKT FEINSTEINZEUG ⁽¹⁾
Feinsteinzeug mit rutschfester Oberfläche⁽¹⁾.

ÁREAS RESIDENCIALES TRAFICABLES
Patios exteriores de viviendas particulares, aparcamientos de bloques multifamiliares (garajes interiores), etc... Pavimentos de tráfico exclusivo de automóviles.
TIPO DE COLOCACIÓN
Colocación con materiales de agarre según el método de "doble encolado".
PRODUCTO GRES PORCELÁNICO ⁽¹⁾
Gres porcelánico con acabado antideslizante ⁽¹⁾.

ПРОЕЗЖИЕ УЧАСТКИ ПРИ ЖИЛЫХ ОБЪЕКТАХ
Дворы частных домов, парковки многоквартирных домов (внутренние гаражи) и т.п. Покрытия, предназначенные для проезда только легковых автомобилей.
ТИП УКЛАДКИ
Клеевая укладка с нанесением клея на монтажную сторону плитки и на облицовываемое основание
ИЗДЕЛИЕ КЕРАМОГРАНИТ ⁽¹⁾
Керамогранит с противоскользящей поверхностью⁽¹⁾.

AREAS FOR PEDESTRIANS ONLY
Patios, gardens and walkways, terraces, balconies, urban pedestrian areas, etc.
INSTALLATION METHOD
"Dry" laying (on grass, sand, and gravel) and raised installation
PRODUCT PORCELAIN TILES ⁽¹⁾
Porcelain tile with a thickness greater than or equal to 20 mm with anti-slip finish ⁽¹⁾.
-
INSTALLATION METHOD
Laying with adhesives using the "double buttering" method.
PRODUCT PORCELAIN TILES ⁽¹⁾
Porcelain tiles with anti-slip finish ⁽¹⁾.

AREE SOLO PEDONABILI
Patii, giardini e camminamenti, terrazze, balconi, aree urbane pedonali, ecc...
TIPO DI POSA
Posa "a secco" (su erba, sabbia e ghiaia) e posa sopraelevata.
PRODOTTO GRES PORCELLANATO ⁽¹⁾
Gres porcellanato a spessore superiore o uguale a 20mm con finitura anti-scivolo ⁽¹⁾.
-
TIPO DI POSA
Posa con adesivi con il metodo della "doppia spalmatura".
PRODOTTO GRES PORCELLANATO ⁽¹⁾
Gres porcellanato con finitura anti-scivolo ⁽¹⁾.

ZONES UNIQUEMENT PIÉTONNES
Patios, jardins et allées, terrasses, balcons, zones urbaines piétonnes, etc...
TYPE DE POSE
Pose "à sec" (sur herbe, sable ou graviers) et pose surélevée.
PRODUIT GRÈS CÉRAME ⁽¹⁾
Grès cérame d'épaisseur supérieure ou égale à 20 mm à finition anti-glisse⁽¹⁾.
-
TYPE DE POSE
Pose à l'aide de colles par la méthode du "double encollage".
PRODUIT GRÈS CÉRAME ⁽¹⁾
Grès cérame à finition anti-glisse ⁽¹⁾.

REINE FUSSGÄNGERBEREICHE
Innenhöfe, Gärten und Gehwege, Terrassen, Balkone, städtische Fußgängerzonen etc.
VERLEGESYSTEM
„Trockenverlegung“ (auf Gras, Sand und Kies) und erhöhte Verlegung.
PRODUKT FEINSTEINZEUG ⁽¹⁾
Feinsteinzeug mit Stärke gleich oder über 20 mm und rutschfester Oberfläche⁽¹⁾.
-
VERLEGESYSTEM
Verlegung mit beidseitig aufgebrachtem Kleber (Buttering-Floating-Verfahren)
PRODUKT FEINSTEINZEUG ⁽¹⁾
Feinsteinzeug mit rutschfester Oberfläche⁽¹⁾.

ÁREAS SOLO PEATONALES
Patios, jardines y terraplenes, terrazas, balcones, áreas urbanas peatonales, etc.
TIPO DE COLOCACIÓN
Colocación "en seco" (sobre césped, arena y grava) y colocación elevada.
PRODUCTO GRES PORCELÁNICO ⁽¹⁾
Gres porcelánico de grosor mayor o igual a 20mm con acabado antideslizante⁽¹⁾.
-
TIPO DE COLOCACIÓN
Colocación con material de agarre según el método de "doble encolado".
PRODUCTO GRES PORCELÁNICO ⁽¹⁾
Gres porcelánico con acabado antideslizante ⁽¹⁾.

ПЕШЕХОДНЫЕ УЧАСТКИ
Пatio, сады, садовые дорожки, террасы, балконы, городские пешеходные площади и т.п.
ТИП УКЛАДКИ
Сухая бесклеевая укладка (на траву, песок, гравий) и укладка на опоры
ИЗДЕЛИЕ КЕРАМОГРАНИТ ⁽¹⁾
Керамогранит толщиной 20 мм или больше с противоскользящей поверхностью ⁽¹⁾.
-
ТИП УКЛАДКИ
Клеевая укладка с нанесением клея на монтажную сторону плитки и на облицовываемое основание.
ИЗДЕЛИЕ КЕРАМОГРАНИТ ⁽¹⁾
Керамогранит с противоскользящей поверхностью⁽¹⁾.

POOL EDGES
INSTALLATION METHOD
Laying with adhesives using the "double buttering" method.
PRODUCT Porcelain tiles ⁽¹⁾
Porcelain tiles with anti-slip finish ⁽¹⁾.

BORDI PISCINA
TIPO DI POSA
Posa con adesivi con il metodo della "doppia spalmatura".
PRODOTTO GRES PORCELLANATO ⁽¹⁾
Gres porcellanato con finitura anti-scivolo ⁽¹⁾.

BORDS DE PISCINE
TYPE DE POSE
Pose à l'aide de colles par la méthode du "double encollage".
PRODUIT GRÈS CÉRAME ⁽¹⁾
Grès cérame à finition anti-glisse ⁽¹⁾.

SCHWIMMBECKENRÄNDER
VERLEGESYSTEM
Verlegung mit beidseitig aufgebrachtem Kleber (Buttering-Floating-Verfahren)
PRODUKT FEINSTEINZEUG ⁽¹⁾
Feinsteinzeug mit rutschfester Oberfläche⁽¹⁾.

BORDES PISCINA
TIPO DE COLOCACIÓN
Colocación con materiales de agarre según el método de "doble encolado".
PRODUCTO GRES PORCELÁNICO ⁽¹⁾
Gres porcelánico con acabado antideslizante ⁽¹⁾.

КРАЯ БАССЕЙНОВ
ТИП УКЛАДКИ
Клеевая укладка с нанесением клея на монтажную сторону плитки и на облицовываемое основание
ИЗДЕЛИЕ КЕРАМОГРАНИТ ⁽¹⁾
Керамогранит с противоскользящей поверхностью⁽¹⁾.

Porcelain tiles for outdoors. Gres porcellanato per esterni.		
ARBOR	grip	✘ 9 mm
ARKSHADE	grip	✘ 9 mm
AIX	grip/textured	✘ 9/20 mm
AXI	textured	✘ 9,5/20 mm
BLAZE	grip/textured	✘ 9/20 mm
BOOST	grip/textured	✘ 9/20 mm
BRAVE	grip/textured	✘ 9/20 mm
DOLMEN PRO	grip/textured	✘ 9/20 mm
DWELL	textured	✘ 20 mm
ECHO	textured	✘ 20 mm
ETIC	textured	✘ 9,5 mm
ETIC PRO	grip/textured	✘ 9/20 mm
EXENCE	grip/textured	✘ 9/20 mm
GRANIGLIATI	textured	✘ 7,6/8,6/12 mm
GROUNDTRACK	matte	✘ 9 mm
KLIF	grip/textured	✘ 9/20 mm
KONE	grip/textured	✘ 9/20 mm
MARK	textured	✘ 9/20 mm
MARVEL PRO	textured	✘ 9/20 mm
MARVEL STONE	textured	✘ 9/20 mm
NASH	grip	✘ 9 mm
NID	textured	✘ 20 mm
RAW	grip/textured	✘ 9/20 mm
SEASTONE	textured	✘ 9/20 mm
SUNROCK	textured	✘ 20 mm
TRUST	grip/textured	✘ 9/20/30 mm

IMPORTANT NOTES | WARNINGS - NOTE IMPORTANTI | AVVERTENZE
NOTES IMPORTANTES | AVERTISSEMENTS/ WICHTIGE HINWEISE | ZUR BEACHTUNG
NOTAS IMPORTANTES | ADVERTENCIAS / ВАЖНЫЕ ПРИМЕЧАНИЯ | ПРЕДУПРЕЖДЕНИЯ

⁽¹⁾ **For the properties of slip resistance required in the aforementioned uses it is always necessary to comply with the local laws, regulations and uses, referring to the technical sheets of the selected products.** Per le proprietà di resistenza allo scivolamento richieste nelle destinazioni d'uso sopra itate occorre sempre attenersi alle normative, leggi ed usi locali facendo riferimento alle schede tecniche dei prodotti selezionati. / Pour les propriétés de résistance à la glissade exigées par les destinations d'usage susmentionnées, il faut toujours respecter les normes, lois et réglementations locales en se référant aux fiches techniques des produits sélectionnés. / Für die von den obigen Zweckbestimmungen verlangte Rutschfestigkeit sind stets die örtlich geltenden Vorschriften, Gesetze und Gebräuche zu beachten. Siehe hierzu die technischen Datenblätter der gewählten Produkte. / Para las propiedades de resistencia al deslizamiento requeridas según los usos previstos antes indicados, es taxativo atenerse a las normativas, leyes y usos locales siempre consultando las fichas técnicas de los productos seleccionados. / Характеристики сопротивления скольжению при использовании плиток для вышеописанных назначений выбирают согласно местным законам, стандартам и правилам по листу технических характеристик выбранных изделий.

⁽²⁾ **If a product with a polished finish is in direct contact with the outdoors, moisture and dirt absorption devices must be used to prevent scratching.** Se il prodotto a finitura lappata è a diretto contatto con l'esterno, occorre prevedere dei dispositivi di assorbimento dell'umidità e della sporizia per prevenire la formazione di graffi. / Si un produit à finition polie est au contact direct avec l'extérieur, il faut prévoir des dispositifs d'absorption de l'humidité et des salissures, ceci afin de prévenir la formation de rayures. / Ist ein Produkt mit geläppter Oberfläche direkt von außen zugänglich, so sind Eingangsmatten zur Aufnahme von Feuchtigkeit und Schmutz erforderlich, um Kratzer zu vermeiden. / El acabado Lapeado pulido está indicado para pisos residenciales o comerciales poco esforzados, donde no se requiera un rendimiento antideslizante, también es ideal para revestimientos. Si el producto está en contacto directo con el exterior, es necesario utilizar los dispositivos de absorción de la humedad y de la suciedad para evitar que se raye. / Если лаппатированная плитка находится в непосредственном контакте с наружной средой, следует предусмотреть подходящие средства поглощения влаги и грязи во избежание образования царапин.

⁽³⁾ **These are general instructions: it is always necessary to check the resistance of the tiling with respect to the maximum expected loads.** Queste sono indicazioni di carattere generale: occorre sempre verificare la resistenza della piastrellatura rispetto ai carichi massimi di progetto. / Ces indications sont de caractère général: il faut toujours vérifier la résistance des carreaux par rapport aux charges maximales prévues dans le projet. / Dies sind allgemeine Hinweise: In jedem Fall ist die Beständigkeit des Fliesenbelags gegen die maximal zu erwartenden Lasten stets zu prüfen. / Estas son indicaciones de carácter general: siempre es necesario verificar la resistencia del embaldosado respecto a las cargas máximas del proyecto. / Данные указания являются указаниями общего характера; рекомендуется всегда проверять стойкость плиточного покрытия с учетом максимальных расчетных нагрузок.

		SAFETY CHARACTERISTICS CARATTERISTICHE DI SICUREZZA *							
Serie / Series Serie / Serie Serie / Серия	Superficie / Surface Surface / Oberfläche Superficie / Поверхность	Shod Ramp Test Metodo della rampa "calzato" (DIN 51130) *				Barefoot Ramp Test Metodo della rampa a piedi nudi (DIN 51097) *			Pendulum Friction Test Metodo del pendolo (BS 7976) *
		R9	R10	R11	R12	A	A+B	A+B+C	≥ 36 Dry ≥ 36 Wet
Aix	Matte Matt		✗				✗		✗
	Grip Grip			✗			✗		✗
	Textured Strutturato			✗			✗		✗
Arbor	Matte Matt		✗				✗		✗
	Matte Matt 7,5x60		✗			✗			(●)
	Matte Matt 30x240		✗			✗			(●)
	Grip Grip			✗			✗		✗
Arkshade	Matte Matt		✗			✗			✗
	Grip Grip			✗			✗		✗
Axi	Matte Matt		✗				✗		✗
	Textured Strutturato			✗			✗		✗
Blaze	Matte Matt		✗				✗		✗
	Matte Matt 6 mm	✗				✗			(●)
	Grip Grip			✗			✗		✗
Boost	Matte Matt		✗				✗		✗
	Matte Matt 6 mm	✗				✗			(●)
	Grip Grip			✗			✗		✗
Brave	Matte Matt		✗				*		✗
	Grip Grip				✗		*		✗
Dolmen Pro	Matte Matt		✗				✗		✗
	Grip Grip			✗			✗		✗
	Textured Strutturato			✗			✗		✗
Dwell	Matte Matt	✗				*			✗
Etic	Matte Matt	✗				*			✗
	Textured Strutturato			✗			*		✗
Etic PRO	Matte Matt	✗				*			✗
	Grip Grip			✗			*		✗
Evolve	Matte Matt	✗				✗			✗
	Textured Strutturato			✗			✗		✗
Exence	Matte Matt		✗				✗		✗
	Grip Grip			✗			✗		✗
Granigliati	Matte Matt	✗ 30x30 cm	✗ 20x20 cm			✗ 30x30 cm	✗ 20x20 cm		✗
	Textured Strutturato			✗			✗ 30x30 cm	✗ 20x20 cm	✗
	Anti-slip type P Antislip tipo P				✗		✗		✗
Greencolors	Grip Grip		✗				✗		✗
Heartwood	Matte Matt 9,5 mm	✗				✗			(●)
	Matte Matt 9 mm		✗				✗		✗
Klif	Matte Matt		✗				✗		✗
	Grip Grip			✗			✗		✗
Kone	Matte Matt		*			*			✗
	Grip Grip			*		*			✗
Mark	Matte Matt		✗			✗			✗
	Textured Strutturato			✗			✗		✗
	Matte Matt 9 mm		✗				✗		✗
Marvel Dream	Matte Matt 6 mm	✗				✗			(●)
	Matte Matt	✗				✗			(●)
Marvel Edge	Matte Matt	✗				✗			✗
Marvel Gems	Matte Matt		✗			✗			✗
Marvel Stone	Matte Matt	✗				✗			✗
	Matte Matt 6 mm	✗				✗			(●)
	Textured Strutturato			✗			✗		✗
Marvel	Matte Matt	✗				✗			✗
	Matte Matt 6 mm	✗				✗			✗
Marvel PRO	Matte Matt	✗				✗			(●)
	Matte Matt 6 mm	✗				✗			(●)
	Textured Strutturato			✗			✗		✗
Mek	Matte Matt		✗			✗			✗
	Matte Matt		✗			✗			✗
Nash	Matte Matt 7,5x60		✗			✗			(●)
	Grip Grip			✗			✗		✗
NID	Matte Matt		✗			✗			✗
	Matte Matt		✗			✗			✗
Raw	Matte Matt 6 mm	✗				✗			(●)
	Grip Grip			✗			✗		✗
Room	Matte Matt		✗			✗			✗
Seastone	Matte Matt	✗				✗			✗
	Textured Strutturato			✗			✗		✗
Trust	Matte Matt		✗				✗		✗
	Grip Grip			✗			✗		✗

Outdoor paving ✗ 20mm

		SAFETY CHARACTERISTICS CARATTERISTICHE DI SICUREZZA *								
Class P1	Class P2	Class P3	Class P4	Pendulum Friction Test Metodo del pendolo (AS 4586)			Coefficient of friction COF Coefficiente di attrito COF (B.C.R.A)	Dynamic coefficient of friction (DCOF) Coefficiente di attrito dinamico DCOF (ANSI A137.1)	Superficie / Surface Surface / Oberfläche Superficie / Поверхность	Serie / Series Serie / Serie Serie / Серия
				Class C1	Class C2	Class C3				
							>0,40 Asciutto >0,40 Bagnato	>0,42 Wet	Matte Matt	Aix
		✗					✗	✗	Grip Grip	
			✗				✗	✗	Textured Strutturato	
							✗	✗	Matte Matt	Arbor
	(●●)						✗	✗	Matte Matt 7,5x60	
	(●●)						✗	✗	Matte Matt 30x240	
			✗				✗	✗	Grip Grip	
	(●●)						✗	✗	Matte Matt	Arkshade
		✗	✗				✗	✗	Grip Grip	
							✗	✗	Matte Matt	Axi
			✗				✗	✗	Textured Strutturato	
							✗	✗	Matte Matt	Blaze
	(●●)						✗	✗	Matte Matt 6 mm	
			✗				✗	✗	Grip Grip	
							✗	✗	Matte Matt	Boost
	(●●)						✗	✗	Matte Matt 6 mm	
			✗				✗	✗	Grip Grip	
	(●●)						✗	✗	Matte Matt	Brave
			✗				✗	✗	Grip Grip	
							✗	✗	Matte Matt	Dolmen Pro
			✗				✗	✗	Grip Grip	
							✗	✗	Textured Strutturato	
(●●)							✗	✗	Matte Matt	Dwell
	(●●)						✗	✗	Matte Matt	Etic
			✗				✗	✗	Textured Strutturato	
	(●●)						✗	✗	Matte Matt	Etic PRO
			✗				✗	✗	Grip Grip	
	(●●)						✗	✗	Matte Matt	Evolve
			✗				✗	✗	Textured Strutturato	
							✗	✗	Matte Matt	Exence
			✗				✗	✗	Grip Grip	
	(●●)	✗ 20x20 cm			✗ 30x30 cm	✗ 20x20 cm	✗	✗	Matte Matt	Granigliati
		✗ 30x30 cm	✗ 20x20 cm		✗ 30x30 cm	✗ 20x20 cm	✗	✗	Textured Strutturato	
			✗			✗ 20x20 cm	✗	✗	Anti-slip type P Antislip tipo P	
							✗	✗	Grip Grip	Greencolors
	(●●)						✗	✗	Matte Matt 9,5 mm	Heartwood
			✗				✗	✗	Matte Matt 9 mm	
							✗	✗	Matte Matt	Klif
			✗				✗	✗	Grip Grip	
	(●●)						✗	✗	Matte Matt	Kone
			✗				✗	✗	Grip Grip	
	(●●)						✗	✗	Matte Matt	Mark
			✗				✗	✗	Textured Strutturato	
							✗	✗	Matte Matt 9 mm	Marvel Dream
	(●●)						✗	✗	Matte Matt 6 mm	
	(●●)						✗	✗	Matte Matt 9,5 mm	
	(●●)						✗	✗	Matte Matt	Marvel Edge
	(●●)						✗	✗	Matte Matt	Marvel Gems
	(●●)						✗	✗	Matte Matt	Marvel Stone
	(●●)						✗	✗	Matte Matt 6 mm	
			✗				✗	✗	Textured Strutturato	
	(●●)						✗	✗	Matte Matt	Marvel
	(●●)						✗	✗	Matte Matt 6 mm	
	(●●)						✗	✗	Matte Matt	Marvel PRO
	(●●)						✗	✗	Matte Matt 6 mm	
			✗				✗	✗	Textured Strutturato	
	(●●)						✗	✗	Matte Matt	Mek
							✗	✗	Matte Matt	
	(●●)						✗	✗	Matte Matt 7,5x60	Nash
			✗				✗	✗	Grip Grip	
							✗	✗	Matte Matt	NID
			✗				✗	✗	Matte Matt	
	(●●)						✗	✗	Matte Matt 6 mm	Raw
							✗	✗	Grip Grip	
	(●●)						✗	✗	Matte Matt	Room
			✗				✗	✗	Matte Matt	Seastone
							✗	✗	Textured Strutturato	
	(●●)						✗	✗	Matte Matt	Trust
			✗				✗	✗	Grip Grip	

Outdoor paving ✗ 20mm

* Determination of slip resistance of pedestrian surfaces; it does not cover sports surfaces and road surfaces for vehicles (skid resistance).
 Determinazione della resistenza allo scivolamento delle superfici pedonabili; non si applica alle pavimentazioni sportive ed alle pavimentazioni stradali veicolari.
 Determination of the resistance au glissement des surfaces piétonnes; elle ne s'applique pas aux sols sportifs, ni aux revêtements routiers.
 Bestimmung der Rutschfestigkeit von begehbaren Oberflächen; gilt nicht für Sportböden und Straßenböden.
 Determinación de la resistencia al deslizamiento de las superficies peatonales; no se aplica a las pavimentaciones deportivas y calzadas.
 Установление сопротивления скольжению напольных покрытий; не применяется к спортивным напольным покрытиям и дорожным покрытиям, предназначенным для проезда транспорта.



(●). PTV ≥ 36 Wet on demand / su richiesta (●●). P3 on demand / su richiesta (●●●). C2 on demand / su richiesta
 (●) Le prestazioni anti-slip vengono garantite al momento della consegna del prodotto. - Anti-slip performance is guaranteed at the time of delivery of the product.

Wall Tiles

Complies with	EN 14411 (ISO 13006)	Appendix	L	Group	BIII
Conforme alla norma	EN 14411 (ISO 13006)	Appendice	L	Gruppo	BIII
Conforme à la norme	EN 14411 (ISO 13006)	Appendice	L	Groupe	BIII
Entsprechend	EN 14411 (ISO 13006)	Anhang	L	Gruppe	BIII
Conforme a la norma	EN 14411 (ISO 13006)	Apéndice	L	Grupo	BIII
Соответствует норме	EN 14411 (ISO 13006)	Приложение	L	Группа	BIII

atlas concorde

Technical specification symbols / Simbologia caratteristiche tecniche

Dimensions Dimensioni Dimensions Maße Tamaño Размер	ISO 10545-2	 Length and width Lunghezza e larghezza Longuer et largeur / Länge und breite / Longitud y anchura / Размеры сторон (*)		
		 Thickness Spessore Épaisseur / Stärke / Grosor / Толщина (**)		
		 Straightness of sides Rettilinearità degli spigoli Rectitude des arêtes / Kantengeradheit / Rectilineidad de las aristas / Кривизна сторон (***)		
		 Rectangularity Ortogonalità Orthogonalité / Rechtwinkligkeit / Ortogonalidad / Косоугольность (****)		
Physical properties Proprietà fisiche Propriétés physiques Physikalische Eigenschaften Propiedades físicas Физические характеристики	ISO 10545-3	 Water absorption Massa d'acqua assorbita Masse d'eau absorbée / Aufgenommene Wassermasse / Peso de agua absorbida / Водопоглощение		
		ISO 10545-4	 BREAKING STRENGTH SFORZO DI ROTTURA Force de rupture / Bruchlast / Esfuerzo de ruptura / Усилие на излом	
			 Modulus of rupture Resistenza alla flessione Résistance à la flexion / Biegefestigkeit / Resistencia a la flexión / Устойчивость к изгибу	
		ISO 10545-8	 Coefficient of thermal linear EXPANSION Coefficiente di DILATAZIONE TERMICA lineare Coefficient de dilatation thermique linéique / Lineare thermische Dehnung Coeficiente de dilatación térmica lineal / Коэффициент линейного расширения	
		ISO 10545-9	 THERMAL SHOCK resistance Resistenza agli SBALZI TERMICI Résistance aux écarts de température / Temperaturwechs elbeständigkeit Resistencia a los cambios de temperatura / Устойчивость к перепаду температур	
		ISO 10545-10	 Moisture expansion (in mm/m) Dilatazione all'umidità (in mm/m) Dilatation à l'humidité (en mm/m) / Feuchtigkeitsausdehnung (in mm/m) Dilatación por la humedad (en mm/m) / Расширение под воздействием влаги (в мм/м)	
		ISO 10545-11	 Crazing resistance Resistenza al cavillo Résistance aux craquelures / Haariß-Beständigkeit / Resistencia a grietas / Устойчивость эмали к кракелюру (старению)	
		EN 1348	 Bond strength/adhesion for improved cementitious adhesives Adesione a trazione con adesivi cementizi migliorati Adhérence par traction avec des ciments-colle améliorés / Scherfestigkeit mit verbesserten zementhaltigen Klebern Adherencia a tracción con adhesivos cementosos mejorados Прочность на растяжение при приклеивании улучшенными цементными клеями	
		-	 Reaction to fire Reazione al fuoco Réaction au feu / Brandverhalten / Reacción al fuego / Огнестойкость	
		Chemical properties Proprietà chimiche Propriétés chimiques Chemische eigenschaften Propiedades químicas Химические характеристики	ISO 10545-13	 Resistance to household chemicals and swimming pool salts Resistenza ai prodotti chimici di uso domestico ed agli additivi per piscina Résistance aux produits chimiques à usage domestique et aux adjuvants pour piscine Beständigkeit gegen Haushaltschemikalien und Badwasserzusätze Resistencia a los productos químicos de uso doméstico Стойкость к химикатам, используемым в быту и для бассейнов
				 Resistance to low concentrations of ACIDS and ALKALIS Resistenza a basse concentrazioni di ACIDI e ALCALI Résistance aux acides et aux alcalis à basse concentration / Beständigkeit gegen niedrigkonzentrierte Säuren und Laugen Resistencia a los ácidos y bases de baja concentración / Сопротивление кислотам и щелочам низкой концентрации
ISO 10545-14	 Resistance to STAINING Resistenza alle MACCHIE Résistance aux taches / Widerstand gegen fleckenbildung / Resistencia a las manchas / Устойчивость эмали к загрязнению			
ISO 10545-15	 Release of dangerous substances: Cadmium (in mg/dm²) and Lead (in mg/dm²) Rilascio di sostanze pericolose: Cadmio (in mg/dm ²) e Piombo (in mg/dm ²) Emission de substances dangereuses: Cadmium (mg/dm ²) et Plomb (mg/dm ²) Emission von gefährlichen Stoffen: Cadmium (mg/dm ²) und Blei (mg/dm ²) Emisión de sustancias peligrosas: Cadmio (mg/dm ²) y Plomo (mg/dm ²) Выделение вредных веществ: кадмия (в мг/дм ²) и свинца (в мг/дм ²)			

(*) The permissible deviation, in % or mm, of the average size for each tile (2 or 4 sides) from work size (WS).
Deviazione ammissibile, in % oppure mm, della dimensione media di ogni piastrella (2 oppure 4 lati) dalla dimensione di fabbricazione (WS).

(**) The permissible deviation, in % or mm, of the average thickness for each tile from the work size thickness (WS).
Deviazione ammissibile, in % oppure mm, dello spessore medio di ogni piastrella dallo spessore riportato nella dimensione di fabbricazione (WS).

(***) The maximum permissible deviation from straightness, in % or mm, related to the corresponding work sizes (WS).
Deviazione massima ammissibile di rettilinearità, in % oppure mm, in rapporto alle dimensioni di fabbricazione (WS) corrispondenti.

(****) The maximum permissible deviation from rectangularity, in % or mm, related to the corresponding work sizes (WS).
Deviazione massima ammissibile di ortogonalità, in % oppure mm, in rapporto alle dimensioni di fabbricazione (WS) corrispondenti.

c.c. The maximum permissible deviation from centre curvature, in % or mm, related to diagonal calculated from the work sizes (WS).
Deviazione massima ammissibile della curvatura del centro, in % oppure mm, in rapporto alla diagonale calcolata secondo le dimensioni di fabbricazione (WS).

e.c. The maximum permissible deviation from edge curvature, in % or mm, related to the corresponding work sizes (WS).
Deviazione massima ammissibile della curvatura dello spigolo, in % oppure mm, in rapporto alle dimensioni di fabbricazione (WS) corrispondenti.

w. The maximum permissible deviation from warpage, in % or mm, related to diagonal calculated from the work sizes (WS).
Deviazione massima ammissibile dello svergolamento, in % oppure mm, in rapporto alla diagonale calcolata secondo le dimensioni di fabbricazione (WS).

			Requirements for nominal size N			3D WALL DESIGN SOLID	AIX	ARBOR
			Requisiti per dimensione nominale N					
			7 cm ≤ N < 15 cm (mm)	N ≥ 15 cm (%) (mm)				
Dimensions Dimensioni Dimensions Maße Tamaño Размер		Length and width Lunghezza e larghezza	± 0,4 (*) Rect.	± 0,3 (*) Rect.	± 1,0 (*) Rect.	Suitable for Conformance	Suitable for Conformance	Suitable for Conformance
		Thickness Spessore	± 0,5 (**)	± 10 (**)	± 0,5 (**)	Suitable for Conformance	Suitable for Conformance	Suitable for Conformance
		Straightness of sides Rettilineità degli spigoli	± 0,4 (***) Rect.	± 0,3 (***) Rect.	± 0,8 (***) Rect.	Suitable for Conformance	Suitable for Conformance	Suitable for Conformance
	Rectangularity Ortogonalità	± 0,4 (****) Rect.	± 0,3 (****) Rect.	± 1,5 (****) Rect.	Suitable for Conformance	Suitable for Conformance	Suitable for Conformance	
	Surface flatness Planarità	c.c. ± 0,6 Rect.	c.c. ± 0,4 Rect.	c.c. ± 1,8 Rect.	Suitable for Conformance	Suitable for Conformance	Suitable for Conformance	
		e.c. ± 0,6 Rect.	e.c. ± 0,4 Rect.	e.c. ± 1,8 Rect.	Suitable for Conformance	Suitable for Conformance	Suitable for Conformance	
		w. ± 0,6 Rect.	w. ± 0,4 Rect.	w. ± 1,8 Rect.	3D WALL Not applicable Non applicable	3D WALL Not applicable Non applicable	3D WALL Not applicable Non applicable	
Physical properties Proprietà fisiche Propriétés physiques Physikalische Eigenschaften Propiedades físicas Физические характеристики		Water absorption (in% by mass) Massa d'acqua assorbita (come % della massa)	Average >10%. When the average > 20%, this shall be indicated. Individual value > 9% Media >10%. Se questo valore > 20%, deve essere indicato. Valore Singolo > 9%			10% < E _v ≤ 20 %	10% < E _v ≤ 20 %	10% < E _v ≤ 20 %
		Breaking strength Sforzo di rottura	S ≥ 600 N			S ≥ 600 N	S ≥ 600 N	S ≥ 600 N
		Modulus of rupture Resistenza alla flessione	R ≥ 15 N/mm ²			R ≥ 15 N/mm ²	R ≥ 15 N/mm ²	R ≥ 15 N/mm ²
				Coefficient of thermal linear expansion Coefficiente di dilatazione termica lineare	Declared value Valore dichiarato			≤ 7 MK ⁻¹
		Thermal shock resistance Resistenza agli sbalzi termici			Pass according to ISO 10545-1 Test superato in accordo con ISO 10545-1			Resistant Resistente
				Moisture expansion (in mm/m) Dilatazione all'umidità (in mm/m)	Declared value Valore dichiarato			≤ 0,06% (0,6mm/m)
		Crazing resistance Resistenza al cavillo			Pass according to EN ISO 10545-1 Test superato in accordo con ISO 10545-1			Resistant Resistente
				Bond strength/adhesion for improved cementitious adhesives Adesione a trazione con adesivi cementizi migliorati	Declared value Valore dichiarato			≥ 1,0 N/mm ² (Class C2 - EN 12004)
	Reaction to fire Reazione al fuoco	Class A1 Classe A1			A1	A1	A1	
		Chemical properties Proprietà chimiche Propriétés chimiques Chemische eigenschaften Propiedades químicas Химические характеристики		Resistance to household chemicals and swimming pool salts Resistenza ai prodotti chimici di uso domestico ed agli additivi per piscina	Minimum Class B Classe minima B			A
Resistance to low concentrations of acids and alkalis Resistenza a basse concentrazioni di acidi e alcali	Declared Class Classe dichiarata			LA	LA	LA		
Resistance to high concentrations of acids and alkalis Resistenza ad alte concentrazioni di acidi e alcali	Declared Class Classe dichiarata			HA	HA	HA		
	Resistance to staining Resistenza alle macchie		Minimum Class 3 Classe 3 minima			5	5	5
	Release of dangerous substances: Cadmium (in mg/dm ²) and Lead (in mg/dm ²) Rilascio di sostanze pericolose: Cadmio (in mg/dm ²) e Piombo (in mg/dm ²)	Declared value Valore dichiarato			≤ 0,01 mg/dm ² Cd ≤ 0,1 mg/dm ² Pb	≤ 0,01 mg/dm ² Cd ≤ 0,1 mg/dm ² Pb	≤ 0,01 mg/dm ² Cd ≤ 0,1 mg/dm ² Pb	

*) The permissible deviation, in % or mm, of the average size for each tile (2 or 4 sides) from work size (WS).
Deviacione ammissibile, in % oppure mm, della dimensione media di ogni piastrella (2 oppure 4 lati) dalla dimensione di fabbricazione (WS).

**) The permissible deviation, in % or mm, of the average thickness for each tile from the work size thickness (WS).
Deviacione ammissibile, in % oppure mm, dello spessore medio di ogni piastrella dallo spessore riportato nella dimensione di fabbricazione (WS).

***) The maximum permissible deviation from straightness, in % or mm, related to the corresponding work sizes (WS).
Deviacione massima ammissibile di rettilineità, in % oppure mm, in rapporto alle dimensioni di fabbricazione (WS) corrispondenti.

****) The maximum permissible deviation from rectangularity, in % or mm, related to the corresponding work sizes (WS).
Deviacione massima ammissibile di ortogonalità, in % oppure mm, in rapporto alle dimensioni di fabbricazione (WS) corrispondenti.

ARKSHADE	ARTY	BLAZE	BOOST	BRICK		BRAVE	DWELL	EWALL	KLIF	KONE	MARVEL EDGE	MARVEL DREAM	MARVEL STONE	MARVEL	MARVEL PRO	MEK	NID	RAW
Matte	Matte	Matte	Matte	N = 8 cm	N = 31,5 cm	Matte	Shiny	Matte	Matte	Matte	Shiny	Shiny	Matte-Shiny	Shiny	Shiny	Matte	Matte	Matte
Suitable for Conformance	Suitable for Conformance	Suitable for Conformance	Suitable for Conformance	Suitable for Conformance	Suitable for Conformance	Suitable for Conformance	Suitable for Conformance	Suitable for Conformance	Suitable for Conformance	Suitable for Conformance	Suitable for Conformance	Suitable for Conformance	Suitable for Conformance	Suitable for Conformance	Suitable for Conformance	Suitable for Conformance	Suitable for Conformance	Suitable for Conformance
Suitable for Conformance	Suitable for Conformance	Suitable for Conformance	Suitable for Conformance	Suitable for Conformance		Suitable for Conformance	Suitable for Conformance	Suitable for Conformance	Suitable for Conformance	Suitable for Conformance	Suitable for Conformance	Suitable for Conformance	Suitable for Conformance	Suitable for Conformance	Suitable for Conformance	Suitable for Conformance	Suitable for Conformance	Suitable for Conformance
Suitable for Conformance	Suitable for Conformance	Suitable for Conformance	Suitable for Conformance	Suitable for Conformance	Suitable for Conformance	Suitable for Conformance	Suitable for Conformance	Suitable for Conformance	Suitable for Conformance	Suitable for Conformance	Suitable for Conformance	Suitable for Conformance	Suitable for Conformance	Suitable for Conformance	Suitable for Conformance	Suitable for Conformance	Suitable for Conformance	Suitable for Conformance
Suitable for Conformance	Suitable for Conformance	Suitable for Conformance	Suitable for Conformance	Suitable for Conformance	Suitable for Conformance	Suitable for Conformance	Suitable for Conformance	Suitable for Conformance	Suitable for Conformance	Suitable for Conformance	Suitable for Conformance	Suitable for Conformance	Suitable for Conformance	Suitable for Conformance	Suitable for Conformance	Suitable for Conformance	Suitable for Conformance	Suitable for Conformance
Suitable for Conformance	Suitable for Conformance	Suitable for Conformance	Suitable for Conformance	Suitable for Conformance	Suitable for Conformance	Suitable for Conformance	Suitable for Conformance	Suitable for Conformance	Suitable for Conformance	Suitable for Conformance	Suitable for Conformance	Suitable for Conformance	Suitable for Conformance	Suitable for Conformance	Suitable for Conformance	Suitable for Conformance	Suitable for Conformance	Suitable for Conformance
Suitable for Conformance	Suitable for Conformance	Suitable for Conformance	Suitable for Conformance	Suitable for Conformance	Suitable for Conformance	Suitable for Conformance	Suitable for Conformance	Suitable for Conformance	Suitable for Conformance	Suitable for Conformance	Suitable for Conformance	Suitable for Conformance	Suitable for Conformance	Suitable for Conformance	Suitable for Conformance	Suitable for Conformance	Suitable for Conformance	Suitable for Conformance
10% < E _v ≤ 20 %	10% < E _v ≤ 20 %	10% < E _v ≤ 20 %	10% < E _v ≤ 20 %	10% < E _v ≤ 20 %	10% < E _v ≤ 20 %	10% < E _v ≤ 20 %	10% < E _v ≤ 20 %	10% < E _v ≤ 20 %	10% < E _v ≤ 20 %	10% < E _v ≤ 20 %	10% < E _v ≤ 20 %	10% < E _v ≤ 20 %	10% < E _v ≤ 20 %	10% < E _v ≤ 20 %	10% < E _v ≤ 20 %	10% < E _v ≤ 20 %	10% < E _v ≤ 20 %	10% < E _v ≤ 20 %
S ≥ 600 N	S ≥ 600 N	S ≥ 600 N	S ≥ 600 N	S ≥ 600 N	S ≥ 600 N	S ≥ 600 N	S ≥ 600 N	S ≥ 600 N	S ≥ 600 N	S ≥ 600 N	S ≥ 600 N	S ≥ 600 N	S ≥ 600 N	S ≥ 600 N	S ≥ 600 N	S ≥ 600 N	S ≥ 600 N	S ≥ 600 N
R ≥ 15 N/mm ²	R ≥ 15 N/mm ²	R ≥ 15 N/mm ²	R ≥ 15 N/mm ²	R ≥ 15 N/mm ²	R ≥ 15 N/mm ²	R ≥ 15 N/mm ²	R ≥ 15 N/mm ²	R ≥ 15 N/mm ²	R ≥ 15 N/mm ²	R ≥ 15 N/mm ²	R ≥ 15 N/mm ²	R ≥ 15 N/mm ²	R ≥ 15 N/mm ²	R ≥ 15 N/mm ²	R ≥ 15 N/mm ²	R ≥ 15 N/mm ²	R ≥ 15 N/mm ²	R ≥ 15 N/mm ²
≤ 7 MK ⁻¹	≤ 7 MK ⁻¹	≤ 7 MK ⁻¹	≤ 7 MK ⁻¹	≤ 7 MK ⁻¹	≤ 7 MK ⁻¹	≤ 7 MK ⁻¹	≤ 7 MK ⁻¹	≤ 7 MK ⁻¹	≤ 7 MK ⁻¹	≤ 7 MK ⁻¹	≤ 7 MK ⁻¹	≤ 7 MK ⁻¹	≤ 7 MK ⁻¹	≤ 7 MK ⁻¹	≤ 7 MK ⁻¹	≤ 7 MK ⁻¹	≤ 7 MK ⁻¹	≤ 7 MK ⁻¹
Resistant Resistente	Resistant Resistente	Resistant Resistente	Resistant Resistente	Resistant Resistente	Resistant Resistente	Resistant Resistente	Resistant Resistente	Resistant Resistente	Resistant Resistente	Resistant Resistente	Resistant Resistente	Resistant Resistente	Resistant Resistente	Resistant Resistente	Resistant Resistente	Resistant Resistente	Resistant Resistente	Resistant Resistente
≤ 0,06% (0,6mm/m)	≤ 0,06% (0,6mm/m)	≤ 0,06% (0,6mm/m)	≤ 0,06% (0,6mm/m)	≤ 0,06% (0,6mm/m)	≤ 0,06% (0,6mm/m)	≤ 0,06% (0,6mm/m)	≤ 0,06% (0,6mm/m)	≤ 0,06% (0,6mm/m)	≤ 0,06% (0,6mm/m)	≤ 0,06% (0,6mm/m)	≤ 0,06% (0,6mm/m)	≤ 0,06% (0,6mm/m)	≤ 0,06% (0,6mm/m)	≤ 0,06% (0,6mm/m)	≤ 0,06% (0,6mm/m)	≤ 0,06% (0,6mm/m)	≤ 0,06% (0,6mm/m)	≤ 0,06% (0,6mm/m)
Resistant Resistente	Resistant Resistente	Resistant Resistente	Resistant Resistente	Resistant Resistente	Resistant Resistente	Resistant Resistente	Resistant Resistente	Resistant Resistente	Resistant Resistente	Resistant Resistente	Resistant Resistente	Resistant Resistente	Resistant Resistente	Resistant Resistente	Resistant Resistente	Resistant Resistente	Resistant Resistente	Resistant Resistente
≥ 1,0 N/mm ² (Class C2 - EN 12004)	≥ 1,0 N/mm ² (Class C2 - EN 12004)	≥ 1,0 N/mm ² (Class C2 - EN 12004)	≥ 1,0 N/mm ² (Class C2 - EN 12004)	≥ 1,0 N/mm ² (Class C2 - EN 12004)	≥ 1,0 N/mm ² (Class C2 - EN 12004)	≥ 1,0 N/mm ² (Class C2 - EN 12004)	≥ 1,0 N/mm ² (Class C2 - EN 12004)	≥ 1,0 N/mm ² (Class C2 - EN 12004)	≥ 1,0 N/mm ² (Class C2 - EN 12004)	≥ 1,0 N/mm ² (Class C2 - EN 12004)	≥ 1,0 N/mm ² (Class C2 - EN 12004)	≥ 1,0 N/mm ² (Class C2 - EN 12004)	≥ 1,0 N/mm ² (Class C2 - EN 12004)	≥ 1,0 N/mm ² (Class C2 - EN 12004)	≥ 1,0 N/mm ² (Class C2 - EN 12004)	≥ 1,0 N/mm ² (Class C2 - EN 12004)	≥ 1,0 N/mm ² (Class C2 - EN 12004)	≥ 1,0 N/mm ² (Class C2 - EN 12004)
A1	A1	A1	A1	A1	A1	A1	A1	A1	A1	A1	A1	A1	A1	A1	A1	A1	A1	A1
A	A	A	A	A	A	A	A	A	A	A	A	A	A	A	A	A	A	A
LA	LA	LA	LA	LA	LA	LA	LA	LA	LA	LA	LA	LA	LA	LA	LA	LA	LA	LA
HA	HA	HA	HA	HA	HA	HA	HA	HA	HA	HA	HA	HA	HA	HA	HA	HA	HA	HA
5	5	5	5	5	5	5	5	5	5	5	5	5	5	5	5	5	5	5
≤ 0,01 mg/dm ² Cd ≤ 0,1 mg/dm ² Pb	≤ 0,01 mg/dm ² Cd ≤ 0,1 mg/dm ² Pb	≤ 0,01 mg/dm ² Cd ≤ 0,1 mg/dm ² Pb	≤ 0,01 mg/dm ² Cd ≤ 0,1 mg/dm ² Pb	≤ 0,01 mg/dm ² Cd ≤ 0,1 mg/dm ² Pb	≤ 0,01 mg/dm ² Cd ≤ 0,1 mg/dm ² Pb	≤ 0,01 mg/dm ² Cd ≤ 0,1 mg/dm ² Pb	≤ 0,01 mg/dm ² Cd ≤ 0,1 mg/dm ² Pb	≤ 0,01 mg/dm ² Cd ≤ 0,1 mg/dm ² Pb	≤ 0,01 mg/dm ² Cd ≤ 0,1 mg/dm ² Pb	≤ 0,01 mg/dm ² Cd ≤ 0,1 mg/dm ² Pb	≤ 0,01 mg/dm ² Cd ≤ 0,1 mg/dm ² Pb	≤ 0,01 mg/dm ² Cd ≤ 0,1 mg/dm ² Pb	≤ 0,01 mg/dm ² Cd ≤ 0,1 mg/dm ² Pb	≤ 0,01 mg/dm ² Cd ≤ 0,1 mg/dm ² Pb	≤ 0,01 mg/dm ² Cd ≤ 0,1 mg/dm ² Pb	≤ 0,01 mg/dm ² Cd ≤ 0,1 mg/dm ² Pb	≤ 0,01 mg/dm ² Cd ≤ 0,1 mg/dm ² Pb	≤ 0,01 mg/dm ² Cd ≤ 0,1 mg/dm ² Pb

c.c. The maximum permissible deviation from centre curvature, in % or mm, related to diagonal calculated from the work sizes (WS).
Deviacione massima ammissibile della curvatura del centro, in % oppure mm, in rapporto alla diagonale calcolata secondo le dimensioni di fabbricazione (WS).

e.c. The maximum permissible deviation from edge curvature, in % or mm, related to the corresponding work sizes (WS).
Deviacione massima ammissibile della curvatura dello spigolo, in % oppure mm, in rapporto alle dimensioni di fabbricazione (WS) corrispondenti.

w. The maximum permissible deviation from warpage, in % or mm, related to diagonal calculated from the work sizes (WS).
Deviacione massima ammissibile dello svergolamento, in % oppure mm, in rapporto alla diagonale calcolata secondo le dimensioni di fabbricazione (WS).

LAYING SUGGESTIONS

Before starting the installation process, make sure the laying surface is well cured, flat and completely clean.

1. CHOICE OF ADHESIVE

The use of an appropriate adhesive is essential for a successful installation. For the installation of ceramic tiles, you should follow the laying instructions provided by leading adhesives manufacturers.

You should choose the most suitable adhesive on the basis of the following factors:

- laying surface
- type and size of tile
- use of tiled surface (floor/wall; indoor/outdoor)
- weather conditions at the time of laying
- waiting time before the ceramic surface can be used

USE	TYPE OF TILE Type	SIZE (cm)	RECOMMENDED ADHESIVES - European Standards EN 12004	
			Normal Set	Rapid set
INDOOR FLOORS				
Cementitious screeds Existing cement floors (cement concrete, bush-hammered) Anhydrite screeds (following application of a suitable primer) Heating floors Existing ceramic, terrazzo and natural stone floors Waterproofing in bathrooms	porcelain stoneware tiles	< 30x30 cm	Improved cementitious adhesives with long open time (Class C2E).	Improved cementitious adhesives, slip resistant and deformable (Class C2FT - S1). ●
		≤ 30x30 cm < 60x60 cm	Improved cementitious adhesives resistant to slip and with long open time (Class C2TE).	Improved cementitious adhesives, slip resistant and deformable (Class C2FT - S1). ●
		≥ 60x60 cm	Improved cementitious adhesives with long open time and deformable (Class C2E - S1).	Improved cementitious adhesives, slip resistant and deformable (Class C2FT - S1). ●
INDOOR WALL TILES				
Cementitious plaster or mortar Plaster (plaster or panels, following application of a suitable primer) Painted walls Cast concrete (Following application of primer on gypsum-based joints) Plasterboard Waterproofing in bathrooms and showers Existing ceramic tiles	white body wall tiles	any size	Improved cementitious adhesives resistant to slip and with long open time (Class C2TE).	Improved cementitious adhesives, slip resistant and deformable (Class C2FT - S1). ●
		< 30x30 cm	Improved cementitious adhesives resistant to slip and with long open time (Class C2TE).	Improved cementitious adhesives, slip resistant and deformable (Class C2FT - S1). ●
		≤ 30x30 cm < 60x60 cm	Improved cementitious adhesives resistant to slip and with long open time (Class C2TE).	Improved cementitious adhesives, slip resistant and deformable (Class C2FT - S1). ●
		≥ 60x60 cm	Improved cementitious adhesives resistant to slip with long open time and deformable (Class C2TE - S1).	Improved cementitious adhesives, slip resistant and deformable (Class C2FT - S1). ●
OUTDOOR FLOORS				
Cementitious screeds Concrete floor Layers of waterproofing	porcelain stoneware tiles	< 30x30 cm	A Improved cementitious adhesives resistant to slip and with long open time (Class C2TE).	Improved cementitious adhesives, slip resistant and deformable (Class C2FT - S1). ●
		≤ 30x30 cm < 60x60 cm	Improved cementitious adhesives resistant to slip with long open time and deformable (Class C2TE - S1).	Improved cementitious adhesives, slip resistant and deformable (Class C2FT - S1). ●
		≥ 60x60 cm	Improved cementitious adhesives with long open time and highly deformable (Class C2E - S2).	Improved cementitious adhesives with long open time and highly deformable (Class C2FE - S2). ●
OUTDOOR WALLS				
Cementitious plaster Concrete cast in situ or prefabricated	porcelain stoneware tiles	< 30x30 cm	Improved cementitious adhesives resistant to slip with long open time and deformable (Class C2TE - S1).	Improved cementitious adhesives, slip resistant and deformable (Class C2FT - S1). ●
		≥ 30x30 cm < 60x60 cm ●●	Improved cementitious adhesives resistant to slip with long open time and deformable (Class C2TE - S1).	Improved cementitious adhesives, slip resistant and deformable (Class C2FT - S1). ●
		≥ 60x60 cm ●●	Improved cementitious adhesives with long open time and highly deformable (Class C2E - S2).	Improved and highly deformable cementitious adhesives (Class C2F - S2). ●

- For large size tiles laid at a height of more than three metres, certain international regulations specify that tiles should be laid using a mixed system of adhesive and mechanical fixtures chosen in relation to the weight of the tile, height of the tiling and site conditions.
- For tiles with a side measuring more than 30 cm laid at heights of more than three meters, certain international regulations specify the use of an additional mechanical anchor that ensures the retention of the tile in case of accidental detachment, to be chosen in relation to the weight of the tile, the height of the tiling and the site conditions.

2. SPREADING THE ADHESIVES AND LAYING THE TILES: TIPS

When laying tiles with a side longer than 60 cm and in any case for commercial indoor environments or outdoors it is essential to apply the adhesive using double buttering, applying the adhesive in a linear method parallel to the short side. It is essential that the direction of application of the adhesive on the substrate is parallel to the direction of application on the back of the tile, thus ensuring perfect adhesion between the tile and substrate.

To minimize the unevenness of the tiles both on the floor and on the wall it is recommended to use "easy installation systems" with spacers and levelers. Spread the adhesive using a suitably toothed spatula.

3. JOINTS AND GROUTING

The invisible joints, i.e., installation with joints smaller than 2 mm, are not recommended.

For straight courses, the maximum offset between tiles must not exceed 1/3 of the length of the adjacent side.

You should follow the instructions provided by leading grout manufacturers.

USE	RECOMMENDED GROUTS - EUROPEAN STANDARDS EN 13888
Residential interiors	Improved cementitious mortars for joints (Class CG2)
Damp interiors (bathrooms, showers) and outdoors	Improved cementitious mortars for joints with low water absorption (CG2 WA)
Commercial premises	Improved cementitious mortars for joints with high resistance to abrasion (Class CG2 A)
Premises requiring total hygiene and resistance to chemical agents (swimming pools, kitchen work surfaces, food industry, hospitals, supermarkets, etc).	Epoxy mortars (Class RG).

3a. ELIMINATION OF EXCESS GROUT

To correctly and easily eliminate excess grout, follow the instructions given by the grout manufacturer. In general, proceed as follows:

Cementitious grouts

When the grout becomes opaque (normally after 10-20 minutes), clean with a hard cellulose sponge using movements on a diagonal to the joints. It is important to respect the drying time to avoid removing the grout from the joints.

Epoxy grouts

When the mixture is still fresh, wet the surface with plenty of water, emulsifying with a pad like Scotch-Brite®, paying attention not to empty the joints.

The residual grout liquid can be removed with a hard cellulose sponge (to be replaced when excessively soaked with resin).

It is vital to remove epoxy grout rapidly before it starts hardening as it is extremely difficult to remove subsequently. If the epoxy grout has started to harden, try adding 10% alcohol to the washing water.

4. CLEANING AND MAINTENANCE

4a. FINAL SITE CLEANING

After a few days, eliminate residues with a commercial Scotch-Brite® pad, brush or single brush floor cleaner (for large surfaces).

For walls, use a neutral detergent in hot water.

For floors, use a mild acid wash diluted according to the type of surface (smooth or textured). It is important to protect marble or metal inserts previously with adhesive tape. Rinse with abundant clean water to eliminate all marks or residues from the joints.

If necessary, repeat the acid wash at a higher concentration, unless there are marble or metal inserts. Do not use diluted commercially-available acids.

4b. ROUTINE MAINTENANCE

You are recommended to use ordinary neutral detergent diluted in water.

Avoid using acid or alkaline products, waxes and/or impregnants and metal pads (iron or steel sponges).

In the event of heavy dirt or particularly textured surfaces, use an alkaline detergent and rinse after washing.

For large surfaces, the use of a floor washing machine is recommended.

4c. EXTRAORDINARY MAINTENANCE

In the event of dirt resistant to the ordinary cleaning, use a suitable detergent for the particular kind of dirt.

TYPE OF DIRT (resistant to ordinary maintenance)	DETERGENT/SOLVENT
Coal, lime efflorescence, chalk, metal marks, rust, graphite, emulsion paint	Acid detergents*
Coca cola, coffee, wine, beer, ice cream	Alkaline detergents
Resin, silicon or mechanical oils, candle wax, paint	Solvents
Tire marks, sole marks, suction cup marks	Alkaline detergent in an abrasive paste

* Important: Acid products may corrode marble, granite, natural stone and metal. Avoid using in the presence of decoration or inserts in these materials

The suggestions and advice given above are the result of research, laboratory tests and many years experience.

However, the cleaning characteristics of the materials may vary significantly depending on the laying method, conditions of use, type of surface and environment. Generally speaking, the higher the non-slip characteristics of the tiles, the more difficult they are to clean.

The maintenance and cleaning operative should always test each cleaning method empirically in advance (if possible on a piece of the material not laid)

In the case of particularly heavy use (for example, mechanical workshops or environments with a heavy presence of oily residues and tire marks), incorrect laying or inappropriate cleaning, Atlas Concorde declines all responsibility for the effectiveness of cleaning and maintenance operations.

Atlas Concorde cannot, under no circumstances, be held responsible for events, damage or defects caused by incorrect laying, negligent cleaning and maintenance or the use of materials and adhesives inappropriate for the use.

For more information, refer to the "Installation, Use, Cleaning, and Maintenance Manual".

CONSEILS POUR LA POSE

Avant toute pose, il est recommandé de s’assurer que le support est suffisamment sec, plan et propre.

1. CHOIX DE LA COLLE

Pour une pose de qualité, il est fondamental d'utiliser une colle appropriée. Toujours respecter les indications fournies par les meilleurs producteurs de colle pour la pose de carreaux céramiques.

Les facteurs ci-après permettent généralement d'identifier l'adhésif le plus approprié :

- type de support ;
- type et format du carrelage ;
- type d'application du revêtement céramique (sol/mur ; intérieur/extérieur) ;
- conditions climatiques au moment de la pose ;
- temps disponible pour la mise en service du revêtement céramique.

TYPE D'APPLICATION Type de support	TYPE DE CARRELAGE Typologie	FORMAT: (cm)	ADHÉSIFS RECOMMANDÉS Normes Européennes En 12004	
			Séchage normal:	Séchage rapide
REVÊTEMENTS DE SOL INTÉRIEURS				
Chapes à base de ciment Revêtements de sol en ciment déjà existants (damés, bouchardés) Chapes anhydrite (Après application d'un primaire approprié) Chapes chauffantes Revêtements de sol déjà existants (Céramique, carreaux de marbre et pierres naturelles) Imperméabilisation salles de bains	carreaux en grès cérame	< 30x30 cm	Mortiers-colles améliorés, à temps ouvert allongé (classe C2E).	Mortiers-colles améliorés résistant au glissement et déformables (classe C2FT - S1). ●
		≤ 30x30 cm < 60x60 cm	Mortiers-colles améliorés résistant au glissement, à temps ouvert allongé (classe C2TE).	Mortiers-colles améliorés résistant au glissement et déformables (classe C2FT - S1). ●
		≥ 60x60 cm	Mortiers-colles améliorés, à temps ouvert allongé et déformables (classe C2E - S1).	Mortiers-colles améliorés résistant au glissement et déformables (classe C2FT - S1). ●
REVÊTEMENTS DE MUR INTÉRIEURS				
Enduit à base de ciment ou mortier Plâtre (enduits ou panneaux, après application d'un primaire approprié) Béton coulé Plâtre cartoné (Après avoir appliqué de l'amorçant sur les joints base plâtre) Imperméabilisation salles de bains et douches Carrelages céramiques déjà existants	carreaux à pâte blanche carreaux en grès cérame	tous formats	Mortiers-colles améliorés résistant au glissement, à temps ouvert allongé (classe C2TE).	Mortiers-colles améliorés résistant au glissement et déformables (classe C2FT - S1). ●
		< 30x30 cm	Mortiers-colles améliorés résistant au glissement, à temps ouvert allongé (classe C2TE).	Mortiers-colles améliorés résistant au glissement et déformables (classe C2FT - S1). ●
		≤ 30x30 cm < 60x60 cm	Mortiers-colles améliorés résistant au glissement, à temps ouvert allongé (classe C2TE).	Mortiers-colles améliorés résistant au glissement et déformables (classe C2FT - S1). ●
		≥ 60x60 cm	Mortiers-colles améliorés résistant au glissement, à temps ouvert allongé et déformables (classe C2TE - S1).	Mortiers-colles améliorés résistant au glissement et déformables (classe C2FT - S1). ●
REVÊTEMENTS DE SOL EXTÉRIEURS				
Chapes à base de ciment Dallage en béton Couches d'imperméabilisation	carreaux en grès cérame	< 30x30 cm	Mortiers-colles améliorés résistant au glissement, à temps ouvert allongé (classe C2TE).	Mortiers-colles améliorés résistant au glissement et déformables (classe C2FT - S1). ●
		≤ 30x30 cm < 60x60 cm	Mortiers-colles améliorés résistant au glissement, à temps ouvert allongé et déformables (classe C2TE - S1).	Mortiers-colles améliorés résistant au glissement et déformables (classe C2FT - S1). ●
		≥ 60x60 cm	Mortiers-colles améliorés, à temps ouvert allongé et hautement déformables (classe C2E - S2).	Mortiers-colles améliorés, à temps ouvert allongé et hautement déformables (classe C2E - S2). ●
REVÊTEMENTS DE MUR EXTÉRIEURS				
Enduit à base de ciment Béton coulé sur place ou préfabriqué	carreaux en grès cérame	< 30x30 cm	Mortiers-colles améliorés résistant au glissement, à temps ouvert allongé et déformables (classe C2TE - S1).	Mortiers-colles améliorés résistant au glissement et déformables (classe C2FT - S1). ●
		≥ 30x30 cm < 60x60 cm ●●	Mortiers-colles améliorés résistant au glissement, à temps ouvert allongé et déformables (classe C2TE - S1).	Mortiers-colles améliorés résistant au glissement et déformables (classe C2FT - S1). ●
		≥ 60x60 cm ●●	Mortiers-colles améliorés, à temps ouvert allongé et hautement déformables (classe C2E - S2).	Mortiers-colles améliorés et hautement déformables (classe C2F - S2). ●

- En cas de pose à basse température ou bien de mise en service rapide du revêtement céramique, il est préférable d'utiliser des mortiers-colles améliorés à prise rapide (Classe C2F – EN 12004).
- En cas de carreaux de côté dépassant 30 cm appliqués à des hauteurs de plus de 3 mètres, certaines normes internationales exigent l'utilisation d'un ancrage mécanique supplémentaire, pour assurer la rétention du carreau en cas de décollage accidentel. Ceux-ci doivent être choisis en fonction du poids du carreau, de la hauteur du revêtement et des conditions sur le chantier.

2. APPLICATION DES COLLES ET POSE DU CARRELAGE

En cas de pose de carreaux ayant un côté de longueur supérieure à 60 cm, ainsi qu'en cas de pose à l'intérieur d'espaces commerciaux ou de pose en extérieur, il est fondamental d'appliquer la colle avec le système du double encollage en appliquant la colle de manière linéaire et parallèle au côté court. Il est fondamental que le sens d'application de la colle sur le support de la pose soit parallèle à celui appliqué au dos du carreau, en garantissant ainsi une adhérence parfaite entre le carreau et le support. Pour réduire tout éventuel décalage du carrelage sur le sol et sur le mur, il est recommandé d'adopter des "systèmes de pose facilitée" en utilisant des croisillons et des niveleurs. Appliquer l'adhésif sur le support avec une spatule à dents adéquates.

3. JOINT ET MASTICAGE

Il est déconseillé d'effectuer des poses à bords unis, à savoir dont les joints sont inférieurs à 2 mm.

En cas de pose "en succession", le décalage maximum entre les carreaux ne doit pas dépasser 1/3 de la longueur du côté adjacent.

Il est recommandé de respecter les indications fournies par les meilleurs producteurs de mortiers pour joints.

TYPE D'APPLICATION	MORTIERS RECOMMANDÉS - Norme Européenne En 13888
Espaces résidentiels intérieurs	Mortiers à base de ciment pour joints améliorés (Classe CG2)
Espaces humides intérieurs (salles de bains, douches) et espaces extérieurs	Mortiers à base de ciment pour joints améliorés à faible absorption d'eau (Classe CG2 WA)
Espaces à usage commercial	Mortiers à base de ciment pour joints améliorés, hautement résistants à l'abrasion (Classe CG2 A)
Espaces nécessitant une hygiène totale et une résistance aux agents chimiques (piscines, plans de travail de cuisines, industries alimentaires, hôpitaux, supermarchés, etc.)	Mortiers époxy (Classe FG).

3a. ÉLIMINATION DU MORTIER EXCÉDENTAIRE

Toujours respecter les indications du fabricant de mortier pour pouvoir éliminer correctement et facilement le produit excédentaire. Il est généralement recommandé de procéder de la façon suivante:

Mortiers à base de ciment

Dès que le mortier devient opaque (généralement au bout de 10-20 minutes), nettoyer à l'aide d'une éponge en cellulose dure en faisant des mouvements diagonaux par rapport aux joints. Il est important de respecter le temps indiqué pour ne pas risquer de retirer le mortier des joints.

Mortiers époxy

Lorsque le mélange est encore frais, mouiller abondamment la surface et émulsionner avec un tampon de type Scotch-Brite® en veillant bien à ne pas vider les joints.

Le résidu liquide de mortier peut s'enlever à l'aide d'une éponge en cellulose dure (à remplacer si elle est trop imprégnée de résine).

Il est fondamental d'éliminer le mortier époxy à temps, avant qu'il ne commence à durcir, après quoi l'opération s'avère extrêmement difficile. Si le mortier a déjà commencé à prendre, essayer d'ajouter 10% d'alcool à l'eau de lavage.

4.NETTOYAGE ET ENTRETIEN

4a. NETTOYAGE EN FIN DE CHANTIER

Au bout de plusieurs jours, nettoyer les résidus de chantier à l'aide d'une éponge commerciale Scotch-Brite® d'un balai-brosse ou d'un balai d'atelier (pour grandes surfaces). Pour les revêtements de mur, utiliser un produit détergent neutre, dilué dans de l'eau chaude.

Pour les revêtements de sol, utiliser un produit détergent acide à effet tampon en variant le pourcentage de dilution selon le type de surface (lisse ou structurée). Il est important de protéger préalablement tout insert en marbre ou en métal avec du ruban adhésif.

Rincer ensuite abondamment avec de l'eau chaude propre jusqu'à ce qu'il n'y ait plus d'auroles ni de résidus dans les interstices.

Répéter si nécessaire le lavage acide à des concentrations plus élevées (s'abstenir s'il y a des inserts en marbre ou en métal). Éviter toute utilisation d'acides commerciaux dilués.

4b. ENTRETIEN ORDINAIRE

Il est recommandé d'utiliser un produit détergent ordinaire, neutre et dilué dans de l'eau.

Éviter toute utilisation d'acides, alcalins, produits de cirage et/ou imprégnants, pailles de fer et éponges métalliques en fer et en acier.

En cas de saleté plus consistante ou de surfaces particulièrement structurées, utiliser un produit détergent à base alcaline et rincer en fin de lavage.

Pour les grandes surfaces, il est recommandé d'utiliser des machines laveuses et sécheuses.

4c. ENTRETIEN EXTRAORDINAIRE

En cas de saleté résistant au nettoyage ordinaire, il est recommandé d'utiliser un produit détergent adapté au type de saleté.

TYPE DE SALETÉ (résistant à l'entretien ordinaire)	DÉTERGENT/SOLVANT
Charbon, efflorescences calcaires, plâtre, signes métalliques, rouille, graphite, peintures murales à la détrempe	Détergents à base acide *
Coca-cola, café, vin, bière, glace	Détergents à base alcaline
Résines, huiles silicones ou mécaniques, cire de bougie, peinture	Solvants
Pneus, semelles en caoutchouc, auréoles provoquées par des ventouses	Détergents basiques en pâte abrasive

* Attention : les produits à base d'acide peuvent ronger le marbre, le granit, les pierres naturelles et les métaux, par conséquent ne pas les utiliser en présence de décors ou d'inserts réalisés avec ces types de matériaux.

Toutefois, les caractéristiques de nettoyabilité des matériaux peuvent varier de façon significative selon les modalités de pose, les conditions d'utilisation, les types de surfaces et de lieux. Généralement, plus les caractéristiques antidérapantes des carreaux sont élevées, plus le nettoyage est difficile.

Avant chaque intervention, l'opérateur professionnel chargé de l'entretien et du nettoyage devra toujours effectuer un contrôle empirique (si possible sur une portion de matériau non posée).

Atlas Concorde décline toute responsabilité quant à l'efficacité des opérations de nettoyage et d'entretien en cas de poses ou de nettoyages défectueux ainsi que dans des conditions d'utilisation particulièrement difficiles (par exemple, dans des ateliers de mécaniciens ou dans des endroits avec des résidus huileux importants et des traces de pneu).

Il est entendu qu'Atlas Concorde ne saurait être tenue pour responsable d'événements, de dommages ou de vices dus à une pose défectueuse, un nettoyage et un entretien négligés ou un mauvais choix du matériau ou des adhésifs pour l'usage considéré.

Pour plus d'informations, consulter le "Manuel de pose, d'emploi, d'entretien et de nettoyage".

SUGERENCIAS PARA LA COLOCACIÓN

Antes de empezar la operación de colocación, se aconseja asegurarse de que la superficie de apoyo esté suficientemente seca, plana y bien limpia.

1. ELECCIÓN DEL ADHESIVO

El empleo de un adhesivo adecuado tiene suma importancia para la colocación. Se aconseja atenerse a las indicaciones de los mejores productores de adhesivos para la colocación de baldosas cerámicas. Por lo general, el adhesivo más adecuado se identifica considerando los siguientes factores:

- tipo de soporte;
- tipología y formato de las baldosas;
- destino de uso (pavimento/revestimiento; interiores/exteriores) del revestimiento cerámico;
- condiciones climáticas en el momento de la colocación;
- tiempos a disposición para la puesta en uso del revestimiento cerámico.

DESTINO DE USO Tipo de soporte	TIPO DE BALDOSAS Tipología	FORMATO (cm)	ADHESIVOS RECOMENDADOS - Normativa Europea EN 12004	
			Toma normal	Toma rápida
PAVIMENTOS INTERNOS				
Morteros cementosos Pavimentos de cemento existentes (batido, bujardado) Bloques delgados de anhidrita (previa aplicación de un producto adecuado de imprimación) Morteros cementosos calefactores Pavimentos de cerámica, baldosas y piedras naturales existentes Impermeabilización en baños	gres porcelánico	< 30x30 cm	Adhesivos cementosos, mejorados con tiempo abierto prolongado (Clase C2E).	Adhesivos cementosos mejorados, resistentes al deslizamiento y deformables (Clase C2FT - S1). ●
		≤ 30x30 cm < 60x60 cm	Adhesivos cementosos mejorados, resistentes al deslizamiento con tiempo abierto prolongado (Clase C2TE).	Adhesivos cementosos mejorados, resistentes al deslizamiento y deformables (Clase C2FT - S1). ●
		≥ 60x60 cm	Adhesivos cementosos mejorados, con tiempo abierto prolongado y deformables (Clase C2E - S1).	Adhesivos cementosos mejorados, resistentes al deslizamiento y deformables (Clase C2FT - S1). ●
REVESTIMIENTOS INTERNOS				
Revoque de cemento o mortero, yeso (revoques o paneles, previa aplicación de un producto adecuado de imprimación) Colada de hormigón Yeso encartonado (Prevía aplicación de imprimación en las juntas a base de yeso) Impermeabilizaciones en baños y duchas Baldosas cerámica existentes	revestimientos de pasta blanca	Cualquier formato	Adhesivos cementosos mejorados, resistentes al deslizamiento con tiempo abierto prolongado (Clase C2TE).	Adhesivos cementosos mejorados, resistentes al deslizamiento y deformables (Clase C2FT - S1). ●
		< 30x30 cm	Adhesivos cementosos mejorados, resistentes al deslizamiento con tiempo abierto prolongado (Clase C2TE).	Adhesivos cementosos mejorados, resistentes al deslizamiento y deformables (Clase C2FT - S1). ●
		≤ 30x30 cm < 60x60 cm	Adhesivos cementosos mejorados, resistentes al deslizamiento con tiempo abierto prolongado (Clase C2TE).	Adhesivos cementosos mejorados, resistentes al deslizamiento y deformables (Clase C2FT - S1). ●
Morteros cementosos Solerías de hormigón Capas de impermeabilización	gres porcelánico	≥ 60x60 cm	Adhesivos cementosos mejorados, resistentes al deslizamiento con tiempo abierto prolongado y deformables (Clase C2TE - S1).	Adhesivos cementosos mejorados, resistentes al deslizamiento y deformables (Clase C2FT - S1). ●
		< 30x30 cm	Adhesivos cementosos mejorados, resistentes al deslizamiento con tiempo abierto prolongado (Clase C2TE).	Adhesivos cementosos mejorados, resistentes al deslizamiento y deformables (Clase C2FT - S1). ●
		≤ 30x30 cm < 60x60 cm	Adhesivos cementosos mejorados, resistentes al deslizamiento con tiempo abierto prolongado y deformables (Clase C2TE - S1).	Adhesivos cementosos mejorados, resistentes al deslizamiento y deformables (Clase C2FT - S1). ●
PAVIMENTOS EXTERNOS				
Morteros cementosos Solerías de hormigón Capas de impermeabilización	gres porcelánico	≥ 60x60 cm	Adhesivos cementosos mejorados, con tiempo abierto prolongado y altamente deformables (Clase C2E - S2).	Adhesivos cementosos mejorados, con tiempo abierto prolongado y altamente deformables (Clase C2FE - S2). ●
		< 30x30 cm	Adhesivos cementosos mejorados, resistentes al deslizamiento con tiempo abierto prolongado y deformables (Clase C2TE - S1).	Adhesivos cementosos mejorados, resistentes al deslizamiento y deformables (Clase C2FT - S1). ●
		≤ 30x30 cm < 60x60 cm	Adhesivos cementosos mejorados, resistentes al deslizamiento con tiempo abierto prolongado y deformables (Clase C2TE - S1).	Adhesivos cementosos mejorados, resistentes al deslizamiento y deformables (Clase C2FT - S1). ●
REVESTIMIENTOS EXTERNOS				
Revoque de cemento Colada de hormigón u hormigón prefabricado	gres porcelánico	≥ 30x30 cm < 60x60 cm ●●	Adhesivos cementosos mejorados, resistentes al deslizamiento con tiempo abierto prolongado y deformables (Clase C2TE - S1).	Adhesivos cementosos mejorados, resistentes al deslizamiento y deformables (Clase C2FT - S1). ●
		≥ 60x60 cm ●●	Adhesivos cementosos mejorados, con tiempo abierto prolongado y altamente deformables (Clase C2E - S2).	Adhesivos cementosos mejorados y altamente deformables (Clase C2F - S2). ●
		< 30x30 cm	s cementosos mejorados, resistentes al deslizamiento con tiempo abierto prolongado y deformables (Clase C2TE - S1).	Adhesivos cementosos mejorados, resistentes al deslizamiento y deformables (Clase C2FT - S1). ●

- En caso de colocación en condiciones de bajas temperaturas o bien si fuera necesario poner en uso rápidamente el revestimiento cerámico, es preferible el empleo de adhesivos cementosos mejorados de fraguado rápido (Clase C2F – EN 12004).
- Para baldosas con lado mayor a 30 cm colocadas a una altura superior a 3 metros, algunas normativas internacionales prevén el empleo de una fijación mecánica suplementaria que asegure la retención de la baldosa en caso de desprendimiento accidental, a elegir según el peso de la baldosa, la altura del revestimiento y las condiciones de la obra.

2. APLICACIÓN DE LOS ADHESIVOS Y COLOCACIÓN DE LAS BALDOSAS: RECOMENDACIONES

En caso de colocación de baldosas con un lado cuyo largo supere los 60 cm, y en cualquier caso para ambientes interiores comerciales o bien en el exterior, es fundamental aplicar el adhesivo con el sistema de doble esparcimiento, aplicando la cola de modo lineal en dirección paralela al lado corto. Es muy importante que la dirección de aplicación del adhesivo en el soporte de colocación sea paralela a la aplicada en el revés de la baldosa, garantizando la perfecta adherencia al interfaz baldosa cerámica y el soporte. Para minimizar los desniveles del sistema de embaldosado en pavimento o de azulejado en revestimiento, se les recomienda adoptar “sistemas de colocación facilitada” con distanciadores y niveladores. Aplicar el adhesivo sobre el soporte utilizando una espátula con un dentado adecuado.

3. ESTUCOS RECOMENDADOS

No se aconseja la colocación de junta unida o colocación con juntas menores a 2 mm.

En el caso de colocación “alternada de las juntas” el escalonado máximo entre las baldosas no tiene que superar 1/3 de la longitud del lado adyacente.

Se recomienda atenerse a las indicaciones de los mejores productores de estucos para juntas.

DESTINO DE USO	ESTUCOS RECOMENDADOS - NORMATIVA EUROPEA EN 13888
Ambientes internos residenciales	Morteros cementosos para juntas mejoradas (Clase CG2)
Ambientes húmedos internos (baños, duchas) y ambientes externos	Morteros cementosos para juntas mejoradas con una reducida absorción de agua (Clase CG2 WA)
Ambientes de uso comercial	Morteros cementosos para juntas mejoradas con una elevada resistencia a la abrasión (Clase CG2 A)
Ambientes en los cuales se requiera una higiene total y resistencia a los agentes químicos (piscinas, encimeras de cocinas, industrias alimenticias, hospitales, supermercados, etc...)	Morteros epoxídicos (Clase RG).

3a. ELIMINACIÓN DEL ESTUCO EN EXCESO

Para una eliminación correcta y sencilla de los residuos de estuco, se recomienda seguir las indicaciones del productor del mismo. Por lo general, se recomienda atenerse a las siguientes recomendaciones.

Estucos de cemento

Cuando el estuco se vuelve opaco (normalmente al cabo de 10-20 minutos), limpiar con una esponja de celulosa dura con movimientos diagonales respecto a las juntas. Es importante respetar estos tiempos para no correr el riesgo de quitar el estuco de las juntas.

Estucos epoxídicos

Con la pasta aún fresca, mojar bien la superficie emulsionando con un estropajo Scotch-Brite®, prestando atención para no vaciar las juntas. El residuo líquido de estuco puede eliminarse con una esponja de celulosa dura (que habrá que cambiar si está demasiado empapada de resina). Es importante eliminar el estuco epoxídico rápidamente antes de que empiece a fraguar, porque quitarlo más tarde resultaría muy difícil. Si el estuco epoxídico ya ha empezado a fraguar, añadir al agua de lavado el 10% de alcohol.

4. LIMPIEZA Y MANTENIMIENTO

4a. LIMPIEZA FINAL DE LA OBRA

Al cabo de algunos días, eliminar los restos de la obra con una esponja comercial Scotch-Brite® o bien con un cepillo grande o monocepillo (para grandes superficies).

Para los revestimientos, utilizar un detergente neutro diluido en agua caliente.

Para los pavimentos, utilizar un detergente ácido tamponado, diluido en un porcentaje variable según el tipo de superficie (lisa o estructurada). Es importante proteger preventivamente con cinta adhesiva las inserciones de mármol o metal si estuvieran presentes.

Aclarar abundantemente con agua caliente limpia hasta que desaparezca cualquier halo o residuo en los intersticios.

Si fuera necesario, repetir el lavado ácido con concentraciones más elevadas, excepto si estuvieran presentes inserciones de mármol o metal. Evitar el empleo de ácidos muriáticos de escasa calidad diluidos.

4b. MANTENIMIENTO ORDINARIO

Se recomienda el uso de un detergente neutro común diluido en agua.

Evitar el empleo de productos ácidos, alcalinos, productos para encerar y/o impermeabilizantes y bayetas de metal (esponjas de hierro y acero).

En caso de suciedad más intensa o superficies muy estructuradas, usar un detergente de base alcalina aclarando al final del lavado.

En caso de grandes superficies se recomienda el uso de máquinas de lavado y secado.

4c. MANTENIMIENTO EXTRAORDINARIO

En caso de restos de suciedad resistentes a la limpieza ordinaria se recomienda el uso de un detergente adecuado dependiendo del tipo de suciedad.

TIPO DE SUCIEDAD (resistente al mantenimiento ordinario)	DETERGENTE/DISOLVENTE
Carbón, eflorescencias calcáreas, yeso, marcas metálicas, óxido, grafito, pinturas murales al temple	Detergentes de base ácida *
Coca cola, café, vino, cerveza, helado	Detergente de base alcalina
Resinas, aceites silicónicos o mecánicos, cera de vela, pintura	Disolventes
Neumáticos, suelas de goma, halos de ventosas	Detergentes básicos en pasta abrasiva

* Atención: los productos de base ácida pueden corroer el mármol, el granito, las piedras naturales y los metales, por tanto hay que evitar su uso en caso de presencia de decoraciones o inserciones realizadas con estos materiales.

Las sugerencias facilitadas arriba son el resultado de investigaciones, comprobaciones de laboratorio y de una experiencia plurianual.

Sin embargo, las características de limpiabilidad de los materiales varían sensiblemente según las diferentes formas de instalación, las condiciones de uso, las tipologías de las superficies y el ambiente. Por lo general, cuanto mayores sean las características antideslizamiento de las baldosas, mayor será la dificultad para limpiarlas.

El profesional encargado del mantenimiento y la limpieza deberá siempre llevar a cabo una comprobación empírica previa (posiblemente en una porción de material no colocado) por cada tipo de intervención.

En caso de condiciones de uso especialmente pesadas (por ejemplo, en talleres mecánicos o en ambientes con una fuerte presencia de residuos oleosos y huellas de neumáticos), instalación incorrecta o limpieza efectuada de manera impropia, Atlas Concorde no se considera responsable de la eficacia de las operaciones de limpieza y mantenimiento.

Se da por descontado que Atlas Concorde no podrá ser considerada responsable de eventos, daños o defectos debidos a una instalación incorrecta, limpieza y mantenimiento negligentes o una elección inadecuada de los materiales instalados y los adhesivos utilizados con respecto al destino.

Para mayor información, consultar el “Manual de Colocación, Uso, Limpieza y Mantenimiento”.

РЕКОМЕНДАЦИИ ПО УКЛАДКЕ

Перед укладкой рекомендуется проверить, что поверхность основания достаточно выдержана, ровная и чистая.

1. ВЫБОР КЛЕЯ

Для качества укладки крайне важно правильно подобрать клей. Рекомендуется следовать указаниям крупнейших изготовителей клеев по укладке керамических плиток.

В целом, клей выбирают с учетом следующих критериев:

- тип основания;
- типология и формат плитки;
- назначение (пол/облицовка; внутри/снаружи) керамического покрытия;
- климатические условия в период укладки;
- время на выполнение керамического покрытия.

НАЗНАЧЕНИЕ Тип основания	ТИП ПЛИТКИ Типология	ФОРМАТ (cm)	РЕКОМЕНДУЕМЫЕ КЛЕИ - Европейские Нормы EN 12004	
			Стандартное схватывание	Быстрое схватывание
ВНУТРЕННИЕ НАПОЛЬНЫЕ ПОКРЫТИЯ				
Цементные стяжки Прежние цементные полы (утрамбованные) Ангидритные стяжки (предварительно нанести нужную грунтовку) Стяжки с подогревом Укладка на существующие полы из керамики, мраморных плиток и природного камня Гидроизоляция в ванных	Керамогранит	< 30x30 cm	Улучшенные клеи на цементной основе с увеличенным сроком хранения в открытом состоянии (Класс C2E).	Улучшенные эластичные клеи на цементной основе, стойкие к оползанию (Класс C2FT - S1). ●
		≤ 30x30 cm < 60x60 cm	Улучшенные клеи на цементной основе стойкие к оползанию с увеличенным сроком хранения в открытом состоянии (Класс C2TE).	Улучшенные эластичные клеи на цементной основе, стойкие к оползанию (Класс C2FT - S1). ●
		≥ 60x60 cm	Улучшенные клеи на цементной основе, стойкие к оползанию с увеличенным сроком хранения в открытом состоянии и эластичные (Класс C2E - S1).	Улучшенные эластичные клеи на цементной основе, стойкие к оползанию (Класс C2FT - S1).●
ВНУТРЕННЯЯ ОБЛИЦОВКА				
Цементная штукатурка или раствор Гипс (штукатурка или панели, предварительно нанести нужную грунтовку) Бетонная заливка Гипсовые панели (После нанесения грунтовки на гипсовые швы) Гидроизоляция в ванных и душах Прежние керамические плитки	плитка из белой глины	любой формат	Улучшенные клеи на цементной основе стойкие к оползанию с увеличенным сроком хранения в открытом состоянии (Класс C2TE).	Улучшенные эластичные клеи на цементной основе, стойкие к оползанию (Класс C2FT - S1). ●
		< 30x30 cm	Улучшенные клеи на цементной основе стойкие к оползанию с увеличенным сроком хранения в открытом состоянии (Класс C2TE).	Улучшенные эластичные клеи на цементной основе, стойкие к оползанию (Класс C2FT - S1). ●
		≤ 30x30 cm < 60x60 cm	Улучшенные клеи на цементной основе стойкие к оползанию с увеличенным сроком хранения в открытом состоянии (Класс C2TE).	Улучшенные эластичные клеи на цементной основе, стойкие к оползанию (Класс C2FT - S1). ●
Керамогранит		≥ 60x60 cm	Улучшенные клеи на цементной основе, стойкие к оползанию с увеличенным сроком хранения в открытом состоянии и эластичные (Класс C2E - S1).	Улучшенные эластичные клеи на цементной основе, стойкие к оползанию (Класс C2FT - S1). ●
		НАРУЖНЫЕ НАПОЛЬНЫЕ ПОКРЫТИЯ		
Цементные стяжки Бетонное перекрытие Гидроизоляционные слои	Керамогранит	< 30x30 cm	Улучшенные клеи на цементной основе стойкие к оползанию с увеличенным сроком хранения в открытом состоянии (Класс C2TE).	Улучшенные эластичные клеи на цементной основе, стойкие к оползанию (Класс C2FT - S1). ●
		≤ 30x30 cm < 60x60 cm	Улучшенные клеи на цементной основе, стойкие к оползанию с увеличенным сроком хранения в открытом состоянии и эластичные (Класс C2TE - S1)	Улучшенные эластичные клеи на цементной основе, стойкие к оползанию (Класс C2FT - S1).●
		≥ 60x60 cm	Улучшенные клеи на цементной основе, стойкие к оползанию с увеличенным сроком хранения в открытом состоянии и с большой эластичностью (Класс C2E - S2).	Улучшенные клеи на цементной основе, стойкие к оползанию с увеличенным сроком хранения в открытом состоянии и с большой эластичностью (Класс C2FE - S2). ●
НАРУЖНАЯ ОБЛИЦОВКА				
Цементная штукатурка Бетонная заливка на месте или бетонные блоки	Керамогранит	< 30x30 cm	Улучшенные клеи на цементной основе, стойкие к оползанию с увеличенным сроком хранения в открытом состоянии и эластичные (Класс C2TE - S1)	Улучшенные эластичные клеи на цементной основе, стойкие к оползанию (Класс C2FT - S1). ●
		≥ 30x30 cm < 60x60 cm ●●	Улучшенные клеи на цементной основе, стойкие к оползанию с увеличенным сроком хранения в открытом состоянии и эластичные (Класс C2TE - S1)	Улучшенные эластичные клеи на цементной основе, стойкие к оползанию (Класс C2FT - S1). ●
		≥ 60x60 cm ●●	Улучшенные клеи на цементной основе, стойкие к оползанию с увеличенным сроком хранения в открытом состоянии и с большой эластичностью (Класс C2E - S2).	Улучшенные высокоэластичные клеи на цементной основе (Класс C2F - S2). ●

- При укладке в условиях низкой температуры, если керамическое покрытие требуется быстро ввести в эксплуатацию, предпочтительнее применять быстрохватывающиеся улучшенные клеи на цементной основе (Класс C2F – EN 12004).
- Для плиток с длиной хотя бы одной из граней более 30 см, укладываемых на высоте более 3 метров, некоторые международные стандарты предусматривают дополнительное механическое крепление, например при помощи специальных крюков, для удержания плитки в случае случайного отрыва; крепеж подбирается с учетом веса плитки, высоты облицовки и конкретных условий стройплощадки.

2. НАНЕСЕНИЕ КЛЕЯ И УКЛАДКА ПЛИТКИ: РЕКОМЕНДАЦИИ

При укладке плитки с длиной хотя бы одной из граней более 60 см и, в любом случае, при укладке плитки в коммерческих помещениях или на улице, клей следует наносить в два слоя: на подлежащее облицовке основание и на тыльную сторону плиток прямыми полосами параллельно короткой грани. Важно, чтобы полосы клея, нанесенного на облицовываемое основание и на тыльную сторону плиток, были параллельны друг другу: это обеспечит оптимальное сцепление плиток с основанием.

Чтобы свести к минимуму неровности или перепады высот облицовки, как на полах, так и на стенах, рекомендуется использовать надлежащие крестики и

592 системы выравнивания плиток.

Наносить клей на основание шпателем с подходящим размером зубьев.

3. ШВЫ И ЗАТИРКА ШВОВ

Не рекомендуется укладывать плитку без швов или со швом менее 2 мм.

При укладке вразбежку смещение плиток должно быть не более 1/3 длины смежных граней.

При затирке швов следуйте указаниям крупнейших производителей шовных затирок.

НАЗНАЧЕНИЕ	РЕКОМЕНДУЕМЫЕ РАСТВОРЫ ЕВРОПЕЙСКИЕ НОРМАТИВЫ EN 13888
Внутренние жилые помещения	Улучшенные цементные растворы для швов (Класс CG2)
Внутренние помещения с высокой влажностью (ванные, души, бассейны и т.п.) и открытые помещения	Улучшенные цементные растворы для швов с низким водопоглощением (Класс CG2 W - EN 13888).
Помещения коммерческого назначения	Улучшенные цементные растворы для швов с повышенной стойкостью к истиранию (Класс CG2 Ar - EN 13888).
Помещения, где требуется полная гигиена и устойчивость к химическим агентам (рабочие столы на кухнях, пищевая промышленность, больницы, супермаркеты и т.п.)	Эпоксидные строительные растворы (Класс RG - EN 13888).

3а. УДАЛЕНИЕ ИЗЛИШКОВ ЗАТИРКИ

Чтобы легко и правильно удалить излишек раствора, рекомендуется следовать указаниям изготовителя раствора.

В общих чертах рекомендуется придерживаться нижеуказанного.

Цементные растворы

Когда раствор теряет блеск (обычно через 10-20 минут), счистить его губкой из твердой целлюлозы, проводя ей по диагонали относительно швов.

Очень важно выдержать указанное время, иначе есть риск удалить раствор из швов.

Эпоксидные растворы

Пока смесь свежая, обильно смочить поверхность, взбивая эмульсию тампоном Scotch-Brite®; действовать осторожно, чтобы не удалить раствор из швов.

Жидкие остатки раствора можно удалить его губкой из твердой целлюлозы (вовремя заменяя ее, когда она сильно пропитывается смолой). Крайне важно удалить эпоксидный раствор вовремя, пока он не начал затвердевать, так как в дальнейшем это будет чрезвычайно трудно сделать. Если эпоксидный раствор уже начал затвердеть, можно попробовать добавить 10% спирта в воду для смывания.

4. ЧИСТКА И УХОД

4а. ЧИСТКА ПО ЗАВЕРШЕНИИ УКЛАДКИ

Через несколько дней очистить уложенное покрытие губкой марки Scotch-Brite®, щеткой или механической щеткой (для больших площадей).

Для облицовки применять нейтральное моющее средство, растворенное в горячей воде. Для напольных покрытий применять кислотное моющее средство тампонирующего действия, концентрация раствора меняется в зависимости от типа поверхности (гладкая или шершавая). Не забывать предварительно защитить мраморные или металлические вставки с помощью клейкой ленты. Прополоскать обильным количеством чистой горячей воды, удаляя все разводы и остатки в промежутках. При необходимости повторить кислотную промывку с более сильной концентрацией, за исключением случаев, когда на полу имеются мраморные или металлические вставки. Избегать применения разведенных кислот для металлов.

4б. ТЕКУЩИЙ УХОД

Рекомендуется пользоваться обычным нейтральным моющим средством, разведенным в воде.

Избегать применения кислотных, щелочных, восковых средств, пропиток и металлических губок.

Для удаления сильных загрязнений или для очистки шершавой поверхности с сильно рельефной структурой пользоваться моющим средством на щелочной основе, прополаскивая после мытья.

Для уборки больших площадей рекомендуется пользоваться моечными машинами, которые выполняют мойку и сушку.

4с. ЧРЕЗВЫЧАЙНЫЙ УХОД

Если загрязнения не удаётся удалить обычным способом, рекомендуется применять моющее средство, подобранное с учетом типа загрязнения.

ТИП ЗАГРЯЗНЕНИЙ (устойчивых к обычной уборке)	МОЮЩЕЕ СРЕДСТВО/РАСТВОРИТЕЛЬ
Уголь, кальциевые налеты, гипс, следы от металлов, ржавчина, графит, стенная темпера	Моющие средства на кислотной основе *
Кока-кола, кофе, вино, пиво, мороженое	Моющие средства на щелочной основе
Смолы, силиконовые масла или масла для механического оборудования, свечной воск, краска	Растворители
Шины, резиновые подошвы, следы от присосок	Основания для очистки в виде абразивной пасты

* Внимание: средства на кислотной основе могут вызвать коррозию мрамора, гранита, природного камня и металлов, поэтому их не следует применять, если имеются декоры или вставки из этих материалов.

Приведенные выше рекомендации являются результатом исследований, лабораторных анализов и многолетнего опыта.

Тем не менее, легкость очистки покрытий значительно меняется при различных способах укладки, условиях эксплуатации, типологиях поверхности и окружающей среды. В целом, чем менее скользкая плитка, тем труднее ее очистить.

Профессиональный работник, отвечающий за уход и очистку, должен всегда провести предварительную пробу (по возможности, на неуложенном материале) по каждому отдельному виду работ.

В случае особо сложных условий (напр., механические мастерские или помещения с большим количеством масляных отходов и следов от шин), ошибок при укладке или неправильного проведения очистки фирма Atlas Concorde снимает с себя всякую ответственность за эффективность операций по очистке и уходу.

Оговаривается, что фирма Atlas Concorde не несет никакой ответственности за происшествия, ущерб или дефекты вследствие ошибок при укладке, халатной очистки и небрежного ухода или неправильного выбора типа устанавливаемых покрытий и клеев для конкретного назначения.

Serie Série Série Série Серия	Formato Size Format Format Размер	Pezzi per scatola Pièces per carton Pièces par boîte Stückzahl x Kart. Piezas por caja шт. в коробке	M² per scatola Sq mts per carton M² par boîte Qm. pro Karton M² por caja M² в коробке	Box per pallet Box per pallet Boîtes per palette Karton pro Palette Cajas por palet Коробок на палете	Peso per scatola (Kg.) Weight x ctn. (Kg.) Poids x boîte (Kg.) Gew. x Kart. (Kg.) Peso por caja (Kg.) шт. вес коробки*	M² per pallet Sq mts per pallet M² par palette Qm. pro Palette M² por palet M² на палете	Peso per pallet (Kg.) Weight x pal. (Kg.) Poids x pal. (Kg.) Gew. x Pal. (Kg.) Peso por palet (Kg.) вес малета*
AIX	120x120	2	2,880	20	58,00	57,60	1.160,00
	75x150	1	1,125	35	25,00	39,55	875,00
	75x75	2	1,125	42	25,00	47,25	1.050,00
	37,5x75	4	1,125	48	25,00	54,00	1.200,00
	22,5x45,3	12	1,223	34	23,70	41,59	805,80
	22,5x22,5	20	1,013	42	19,40	42,53	814,80
	120x120 20mm	1	1,440	20	67,66	28,80	1.353,20
	60x90 20mm	2	1,080	18	48,50	19,44	873,00
	60x60 20mm	2	0,720	30	33,00	21,60	990,00
	22,5x45,4 20mm	5	0,510	40	20,43	20,40	817,20
ARBOR	22,5x22,5 20mm	11	0,556	40	22,72	22,24	908,80
	30x240	1	0,720	72	14,50	51,84	1.044,00
	18,5x150	4	1,110	40	24,96	44,40	998,40
	15x90	10	1,350	36	26,67	48,60	960,12
	7,5x60	22	0,990	60	19,10	59,40	1.146,00
	75x150	1	1,125	35	25,00	39,55	875,00
	75x75	2	1,125	42	25,00	47,25	1.050,00
	45x90	3	1,215	36	24,60	43,74	885,60
	60x60	3	1,080	40	21,57	43,20	862,80
	30x60	7	1,260	40	24,85	50,40	994,00
ARKSHADE	120x240	1	2,880	18	58,00	51,84	1.044,00
	120x120	2	2,880	20	58,00	57,60	1.160,00
	22,5x90	6	1,215	36	26,73	43,74	962,28
	15x90	10	1,350	36	28,00	48,60	1.008,00
	40x120 20mm	2	0,960	24	41,50	23,04	996,00
	45x90 20mm	2	0,810	27	37,00	21,87	999,00
	60x60 20mm	2	0,720	30	33,00	21,60	990,00
	75x150	1	1,125	35	26,50	39,55	927,50
	75x75	2	1,125	42	25,00	47,25	1.050,00
	120x278	1	3,336	18	45,00	60,05	810,00
BLAZE	120x120	2	2,880	20	58,00	57,60	1.160,00
	37,5x75	4	1,125	48	25,00	54,00	1.200,00
	120x120 20mm	1	1,440	20	67,66	28,80	1.353,20
	60x60 20mm	2	0,720	30	33,00	21,60	990,00
	120x278	1	3,336	18	45,00	60,05	810,00
	120x240	1	2,880	18	58,00	51,84	1.044,00
	120x120	2	2,880	20	58,00	57,60	1.160,00
	120x120 6mm	2	2,880	20	40,32	57,60	806,40
	75x150	1	1,125	35	26,50	39,55	927,50
	75x75	2	1,125	42	25,00	47,25	1.050,00
BOOST	45x90	3	1,215	36	24,60	43,74	885,60
	60x60	3	1,080	40	21,57	43,20	862,80
	30x60	7	1,260	40	24,85	50,40	994,00
	120x240 20mm	1	2,880	9	134,00	25,92	1.206,00
	60x120 20mm	1	0,720	35	33,35	10,80	1.167,25
	90x90 20mm	1	0,810	18	37,60	14,58	676,80
	75x150	1	1,125	35	25,00	39,55	875,00
	75x75	2	1,125	42	25,00	47,25	1.050,00
	45x90	3	1,215	36	24,60	43,74	885,60
	60x60	3	1,080	40	21,23	43,20	849,20
BRAVE	30x60	7	1,260	40	24,85	50,40	994,00
	40x120 20mm	2	0,960	24	41,50	23,04	996,00
	60x120 20mm	1	0,720	35	33,35	10,80	1.167,25
	45x90 20mm	2	0,810	27	37,00	21,87	999,00
	30x60 20mm	3	0,540	40	21,60	21,60	960,00
	75x150	1	1,125	35	25,00	39,55	875,00
	75x75	2	1,125	42	25,00	47,25	1.050,00
	37,5x75	4	1,125	48	25,00	54,00	1.200,00
	22,5x45,3	12	1,223	34	23,70	41,59	805,80
	22,5x22,5	20	1,013	42	19,40	42,53	814,80
DOLMEN PRO	60x120 20mm	1	0,720	35	33,35	10,80	1.167,25
	22,5x45,4 20mm	5	0,510	40	20,43	20,40	817,20
	22,5x22,5 20mm	11	0,556	40	22,72	22,24	908,80
	75x150	1	1,125	35	24,50	39,55	857,50
	75x75	2	1,125	42	25,00	47,25	1.050,00
	45x90	3	1,215	36	24,60	43,74	885,60
	60x60	3	1,080	40	21,23	43,20	849,20
	30x60	7	1,260	40	24,85	50,40	994,00
	120x120	2	2,880	20	58,00	57,60	1.160,00
	90x90 20mm	1	0,810	18	37,60	14,58	676,80

ECHO	90x90 20mm	1	0,810	18	37,60	14,58	676,80
	22,5x90	6	1,215	36	26,73	43,74	962,28
ETIC	15x90	10	1,350	36	28,00	48,60	1.008,00
	11x90	12	1,188	36	25,50	42,77	918,00
ETIC PRO	25x150	3	1,125	30	25,00	33,75	750,00
	22,5x90	6	1,215	36	25,20	43,74	907,20
	15x90	10	1,350	36	26,67	48,60	960,12
	30x120 20mm	2	0,720	16	33,00	11,52	528,00
EVOLVE	60x60	3	1,080	40	22,20	43,20	88,00
	30x60	7	1,260	40	24,85	50,40	994,00
EXENCE	18,5x150	4	1,110	40	24,96	44,40	998,40
	20x120	6	1,440	42	31,10	51,84	1.306,20
GRANIGLIATI	30x120 20mm	2	0,720	16	33,00	11,52	528,00
	30x30	12	1,080	48	20,10	51,84	964,80
	20x20	30	1,200	60	18,90	72,00	1.134,00
GREENCOLORS	20x20 Sp. 12mm	18	0,720	60	19,80	43,20	1.188,00
	20x20	36	1,440	56	23,18	80,64	1.298,08
GROUND TRACK	30x30	12	1,080	30	22,00	32,40	660,00
	18,5x150	4	1,110	40	24,96	44,40	998,40
HEARTWOOD	20x120	6	1,440	42	31,10	51,84	1.306,20
	75x150	1	1,125	35	25,00	39,55	875,00
KLIF	75x75	2	1,125	42	25,00	47,25	1.050,00
	37,5x75	4	1,125	48	25,00	54,00	1.200,00
	90x90 20mm	1	0,810	18	37,60	14,58	676,80
	45x90 20mm	2	0,810	27	37,00	21,87	999,00
	60x60 20mm	2	0,720	30	33,00	21,60	990,00
KONE	75x150	1	1,125	35	25,00	39,55	875,00
	75x75	2	1,125	42	25,00	47,25	1.050,00
	60x60	3	1,080	40	22,50	43,20	900,00
	30x60	7	1,260	40	24,85	50,40	994,00
	120x278	1	3,336	18	45,00	60,05	810,00
	120x240	1	2,880	18	58,00	51,84	1.044,00
	120x120	2	2,880	20	58,00	57,60	1.160,00
	45x90	3	1,215	36	25,95	43,74	934,20
	45x90 20mm	2	0,810	27	37,00	21,87	999,00
	60x60 20mm	2	0,720	30	33,00	21,60	990,00
MARK	45x90	3	1,215	36	25,00	43,74	900,00
	60x60	3	1,080	40	21,23	43,20	849,20
	30x60	7	1,260	40	24,85	50,40	994,00
	22,5x90	6	1,215	36	25,20	43,74	907,20
MARVEL	60x60 20mm	2	0,720	30	33,00	21,60	990,00
	120x278	1	3,336	18	45,00	60,05	810,00
	120x240	1	2,880	18	58,00	51,84	1.044,00
	120x120	2	2,880	20	58,00	57,60	1.160,00
	60x120	2	1,440	35	35,00	21,60	1.225,00
	75x150	1	1,125	35	26,50	39,55	927,50
	75x75	2	1,125	42	25,00	47,25	1.050,00
	45x90	3	1,215	36	25,50	43,74	918,00
	60x60	3	1,080	40	21,23	43,20	849,20
	30x60	7	1,260	40	24,85	50,40	994,00
MARVEL DREAM	120x278	1	3,336	18	45,00	60,05	810,00
	120x240	1	2,880	18	58,00	51,84	1.044,00
	120x120	2	2,880	20	58,00	57,60	1.160,00
	75x150	1	1,125	35	26,50	39,55	927,50
MARVEL EDGE	75x75	2	1,125	42	25,00	47,25	1.050,00
	37,5x75	4	1,125	48	25,00	54,00	1.200,00
	60x60	3	1,080	40	21,23	43,20	849,20
	120x278	1	3,336	18	45,00	60,05	810,00
	120x240	1	2,880	18	58,00	51,84	1.044,00
	120x120	2	2,880	20	58,00	57,60	1.160,00
	75x150	1	1,125	35	26,50	39,55	927,50
	75x75	2	1,125	42	25,00	47,25	1.050,00
	45x90	3	1,215	36	24,60	43,74	885,60
	60x60	3	1,080	40	21,23	43,20	849,20
MARVEL GEMS	30x60	7	1,260	40	24,85	50,40	994,00
	60x60	3	1,080	40	21,23	43,20	849,20
MARVEL PRO	120x278	1	3,336	18	45,00	60,05	810,00
	120x240	1	2,880	18	58,00	51,84	1.044,00
	120x120	2	2,880	20	58,00	57,60	1.160,00
	60x120	2	1,440	35	35,00	21,60	1.225,00
	75x150	1	1,125	35	26,50	39,55	927,50
	75x75	2	1,125	42	25,00	47,25	1.050,00
	45x90	3	1,215	36	25,50	43,74	918,00
	60x60	3	1,080	40	21,23	43,20	849,20
	30x60	7	1,260	40	24,85	50,40	994,00
	60x60 Satin	3	1,080	40	24,34	43,20	973,60

* +/- 10%
The reported values do not include the weight of pallets.
I valori riportati non comprendono il peso dei pallet.

Serie Series Série Serie Серия	Formato Size Format Format Formato Размер	Pezzi per scatola Pieces per carton Pièces par boîte Stückzahl x Kart. Piezas por caja шт. в коробке	M² per scatola Sq mts per carton M² par boîte Qm. pro Karton M² por caja M² в коробке	Box per pallet Box per pallet Boîtes per palette Karton pro Palette Cajas por palet Коробок на палете	Peso per scatola (Kg.) [*] Weight x ctn. (Kg.) [*] Poids x boîte (Kg.) [*] Gew. x Kart. (Kg.) [*] Peso por caja (Kg.) [*] шт. вес коробки [*]	M² per pallet Sq mts per pallet M² par palette Qm. pro Palette M² por palet M² на палете	Peso per pallet (Kg.) [*] Weight x pal. (Kg.) [*] Poids x pal. (Kg.) [*] Gew. x Pal. (Kg.) [*] Peso por palet (Kg.) [*] вес малета [*]
MARVEL STONE	120x278	1	3,336	18	45,00	60,05	810,00
	120x240	1	2,880	18	58,00	51,84	1.044,00
	120x120	2	2,880	20	58,00	57,60	1.160,00
	60x120	2	1,440	35	35,00	21,60	1.225,00
	75x150	1	1,125	35	26,50	39,55	927,50
	75x75	2	1,125	42	25,00	47,25	1.050,00
	45x90	3	1,215	36	24,60	43,74	885,60
	60x60	3	1,080	40	21,23	43,20	849,20
	30x60	7	1,260	40	24,85	50,40	994,00
	60x120 20mm	1	0,720	35	33,35	10,80	1.167,25
MEK	60x60 20mm	2	0,720	30	33,00	21,60	990,00
	30X60 20mm	3	0,540	40	24,00	21,60	960,00
	75x150	1	1,125	35	25,00	39,55	875,00
	45x90	3	1,215	36	24,60	43,74	885,60
NASH	60x60	3	1,080	40	21,23	43,20	849,20
	30x60	7	1,260	40	24,85	50,40	994,00
	18,5x150	4	1,110	40	24,96	44,40	998,40
NID	20x120	6	1,440	32	31,10	51,84	995,20
	7,5x60	22	0,990	60	19,10	59,40	1.146,00
	25x150	3	1,125	30	25,00	33,75	750,00
RAW	18,5x150	4	1,110	40	24,96	44,40	998,40
	15x90	10	1,350	36	26,67	48,60	960,12
	40x120 20mm	2	0,960	24	41,50	23,04	996,00
	120x278	1	3,336	18	45,00	60,05	810,00
	120x120	2	2,880	20	58,00	57,60	1.160,00
	75x150	1	1,125	35	26,50	39,55	927,50
	75x75	2	1,125	42	25,00	47,25	1.050,00
	37,5x75	4	1,125	48	25,00	54,00	1.200,00
	60x60	3	1,080	40	21,57	43,20	862,80
	30x60	7	1,260	40	24,85	50,40	994,00
ROOM	120x120 20mm	1	1,440	20	67,66	28,80	1.353,20
	60x120 20mm	1	0,720	35	33,35	10,80	1.167,25
	60x60	3	1,080	40	21,23	43,20	849,20
SEASTONE	30x60	7	1,260	40	24,85	50,40	994,00
	60x60 20mm	2	0,720	30	33,00	21,60	990,00
	60x60 20mm	2	0,720	30	33,00	21,60	990,00
TRUST	45x90	3	1,215	36	24,60	43,74	885,60
	22,5x90	6	1,215	36	25,20	43,74	907,20
	60x60	3	1,080	40	22,38	43,20	895,20
	40x60	4	0,960	60	19,84	57,60	1.190,40
	30x60	7	1,260	40	24,85	50,40	994,00
	20x60	7	0,840	72	17,22	60,48	1.239,84
	30x30	11	0,990	48	20,26	47,52	972,48
	60x120 20mm	1	0,720	35	33,35	10,80	1.167,25
	45x90 20mm	2	0,810	27	37,00	21,87	999,00
	60x60 20mm	2	0,720	30	33,40	21,60	1.002,00
MARVEL WALL	30X60 20mm	3	0,540	40	24,75	21,60	990,00
	60X60 30mm	1	0,360	40	23,68	14,40	947,20

* +/- 10%
The reported values do not include the weight of pallets.
I valori riportati non comprendono il peso dei pallet.

February 2020
Reported data can be subject to variations throughout the year, present values are updated on the date of catalogue printing.
I dati riportati possono subire delle variazioni nel corso dell'anno, i valori sono aggiornati al mese di stampa.

Serie Series Série Serie Серия	Formato Size Format Format Formato Размер	Pezzi per scatola Pieces per carton Pièces par boîte Stückzahl x Kart. Piezas por caja шт. в коробке	M² per scatola Sq mts per carton M² par boîte Qm. pro Karton M² por caja M² в коробке	Box per pallet Box per pallet Boîtes per palette Karton pro Palette Cajas por palet Коробок на палете	Peso per scatola (Kg.) [*] Weight x ctn. (Kg.) [*] Poids x boîte (Kg.) [*] Gew. x Kart. (Kg.) [*] Peso por caja (Kg.) [*] шт. вес коробки [*]	M² per pallet Sq mts per pallet M² par palette Qm. pro Palette M² por palet M² на палете	Peso per pallet (Kg.) [*] Weight x pal. (Kg.) [*] Poids x pal. (Kg.) [*] Gew. x Pal. (Kg.) [*] Peso por palet (Kg.) [*] вес малета [*]	
3D WALL DESIGN	3D Kite 50x110	3	1,650	40	24,50	66,00	980,00	
	3D Line 50x110	3	1,650	33	36,00	54,45	1.188,00	
	3D Flows 50x110	3	1,650	33	36,00	54,45	1.188,00	
	3D Ultra Blade 50x110 Matt	3	1,650	33	36,00	54,45	1.188,00	
	3D Ultra Blade 50x110 Glossy	3	1,650	33	36,00	54,45	1.188,00	
	3D Plot 50x110	3	1,650	33	36,00	54,45	1.188,00	
	3D Flake 40x80	3	1,650	32	36,00	52,80	1.152,00	
	3D Twist 40x80	4	1,280	54	18,80	69,12	1.015,20	
	3D Flash 40x80	4	1,280	48	19,68	61,44	944,64	
	3D Diamond 40x80	4	1,280	48	20,50	61,44	984,00	
	3D Blade 40x80	4	1,280	48	21,20	61,44	1.017,60	
	3D Stars 40x80	4	1,280	48	21,20	61,44	1.017,60	
	3D Angle 40x80	4	1,280	48	20,50	61,44	984,00	
	3D Mesh 40x80	4	1,280	48	20,50	61,44	984,00	
	3D Wind 40x80	4	1,280	48	20,40	61,44	979,20	
	3D Dune 40x80	4	1,280	48	20,50	61,44	984,00	
	3D Wave 40x80	4	1,280	48	21,20	61,44	1.017,60	
	3D Ribbon 40x80	4	1,280	48	20,80	61,44	998,40	
	3D Line 30,5x56	4	1,280	48	20,50	61,44	984,00	
	AIX Wall	3D Wave 30,5x56	4	1,280	48	21,20	61,44	1.017,60
3D Ultra 30,5x56		9	1,537	32	22,68	49,19	725,76	
Solid 50x110		8	1,366	32	26,00	43,72	832,00	
Solid 40x80		8	1,366	32	20,00	43,72	640,00	
Solid 30,5x56		8	1,366	32	22,00	43,72	704,00	
40x80		4	1,280	54	19,00	69,12	1.026,00	
3D Row 40x80		4	1,280	48	21,20	61,44	1.017,60	
ARBOR Wall		3D Wooden 40x80	4	1,280	48	21,20	61,44	1.017,60
		Solid 40x80	4	1,280	54	18,80	69,12	1.015,20
ARKSHADE Wall		40x80	4	1,280	54	19,00	69,12	1.026,00
	3D Stars 40x80	4	1,280	48	21,20	61,44	1.017,60	
ARTY Wall	40x80	4	1,280	54	18,16	69,12	980,64	
	3D Wave 40x80	4	1,280	48	21,20	61,44	1.017,60	
BLAZE Wall	50x110	3	1,650	40	25,75	66,00	1.030,00	
	40x80	4	1,280	54	18,80	69,12	1.015,20	
BOOST Wall	3D Urban 40x80	4	1,280	48	21,20	61,44	1.017,60	
	40x80	4	1,280	54	18,80	69,12	1.015,20	
BRAVE Wall	3D Wave 40x80	4	1,280	48	21,20	61,44	1.017,60	
	40x80	4	1,280	54	18,80	69,12	1.015,20	
BRICK Wall	8x31,5	20	0,504	84	8,10	42,34	680,40	
	40x80	4	1,280	54	18,80	69,12	1.015,20	
DWELL Wall	50x110	3	1,650	40	24,50	66,00	980,00	
	40x80	4	1,280	54	18,16	69,12	980,64	
EWALL Wall	40x80	4	1,280	54	19,00	69,12	1.026,00	
	3D Row 40x80	4	1,280	48	21,20	61,44	1.017,60	
KLIF Wall	50x110	3	1,650	40	24,50	66,00	980,00	
	40x80	4	1,280	54	19,00	69,12	1.026,00	
	3D Line 50x110	3	1,650	33	36,00	54,45	1.188,00	
	3D Stars 40x80	4	1,280	48	21,20	61,44	1.017,60	
KONE Wall	50x110	3	1,650	40	24,50	66,00	980,00	
	30,5x91,5	5	1,395	42	22,50	58,59	945,00	
	40x80	4	1,280	54	18,16	69,12	980,64	
	40x80	4	1,280	54	22,50	49,19	720,00	
MARVEL Wall	30,5x91,5	5	1,395	42	21,86	58,59	918,12	
	50x110	3	1,650	40	27,60	66,00	1.104,00	
	50x110	3	1,650	40	24,50	66,00	980,00	
	40x80	4	1,280	54	19,00	69,12	1.026,00	
MARVEL DREAM Wall	50x110	3	1,650	40	24,50	66,00	980,00	
	30,5x91,5	5	1,395	42	21,55	58,59	905,10	
	40x80	4	1,280	54	19,00	69,12	1.026,00	
	3D Ribbon 40x80	4	1,280	48	21,80	61,44	1.046,40	
MARVEL EDGE Wall	8x31,5	20	0,504	84	8,10	42,34	680,40	
	50x110	3	1,650	40	24,50	66,00	980,00	
	3D Plot 50x110	3	1,650	33	36,00	54,45	1.188,00	
	40x80	4	1,280	54	19,70	69,12	1.063,80	
MARVEL PRO Wall	3D Mesh 40x80	4	1,280	48	21,80	61,44	1.046,40	
	50x110	3	1,650	40	26,50	66,00	1.060,00	
	3D FOLD 50x110	3	1,650	33	28,20	54,45	930,60	
	3D U.Blade 50x110	3	1,650	33	28,80	54,45	950,40	
NID Wall	3D Wooden 40x80	4	1,280	48	21,20	61,44	1.017,60	
	50x110	3	1,650	40	25,75	66,00	1.030,00	
RAW Wall	3D Scratch 50x110	3	1,650	36	29,00	59,40	1.044,00	

General sales conditions

A.- CONTRACT COMPLETION

A.1. These general sales conditions govern every sales contract between the Seller and the Buyer and any amendment or exception thereof shall be agreed in writing.

A.2. Any offers, credits and/or rebates granted by agents or other intermediaries, shall not be considered valid if they are not confirmed in writing by the Seller.

A.3. The Buyer shall send the written orders to the Seller, directly or through the agents, and the orders shall include the codes of the required products, quantity, price and destination. The order sent by the Buyer is irrevocable.

A.4. The sale shall be deemed completed when: (i) the Buyer receives a written confirmation from the Seller, via e-mail, fax or other electronic means, that complies with the terms and conditions of the order; or (ii) if the confirmation sent by the Seller contains conditions that differ from the order sent by the Buyer, when the latter accepts it in writing or in any case does not object within 7 (seven) days from reception; or (iii) if the Seller does not provide a written confirmation, when the products are delivered and loaded by the Buyer.

A.5. The Buyer shares the need to restrict the sales of Atlas Concorde products to the national territory.

The Seller deems this rule necessary in order to coordinate its sales policy, streamline its distribution network and provide offers that are suited to the needs of the single countries.

The Buyer acknowledges that this rule is also in its best interest.

The Buyer therefore undertakes to market the products supplied by Ceramiche Atlas Concorde SpA exclusively in its country of residence, refraining from promoting active sales, even online, with customers located in the territory of a country different from its own.

As regards triangular operations, this undertaking applies to the country in which the buyer actually operates.

The Buyer may resell the product outside its territory only with written authorisation from the Seller, or if the sales concern non first-grade products or products that are out of production.

B.- PRICES

B.1. The prices agreed upon for each individual sale are net prices for cash delivery ex works (the Seller's plant shall be specified in the order confirmation), unless otherwise agreed in writing.

C.- PRODUCT CHARACTERISTICS

C.1. The Buyer declares to have read and comply with the content of the following documentation published on the corporate website: 1) Laying, use, cleaning and maintenance manual and 2) Technical data sheets.

C.2. Given the intrinsic variability of the ceramic products, the characteristics of the samples, previously sent by the Seller to the Buyer, are purely illustrative and cannot be deemed binding.

C.3. Unless specifically requested and agreed before the order confirmation, the Seller does not guarantee that the entire quantity of an article on order shall be sent from one same production lot.

D.- DELIVERY TERMS

D.1. The delivery terms are approximate and a delay does not give the Buyer any right to claim compensation, without any exception.

D.2. If the Buyer does not collect the goods, after 10 (ten) days from the date of the "goods ready" notice, the Seller has the right – at its discretion – to establish a new delivery date.

E.- SHIPPING ARRANGEMENTS AND TERMS

E.1. The Buyer must communicate any variation in the destination of the products, different from the one agreed in the order confirmation, in writing within, and no later than, the second day before the day foreseen for the collection at the Seller's premises. The Seller reserves the right not to accept the change of the product destination. If the actual destination of the product is different from the one stated by the Buyer, the Seller reserves the right to suspend the execution of the supplies underway and/or to terminate the contracts in force and the Buyer shall not have the right to claim direct and/or indirect compensation of any type.

E.2. Unless otherwise agreed, the goods shall be delivered ex-works (EXW - Incoterms 2010) and this shall also be the case when the parties agree that the delivery, or part of it, shall be arranged by the Seller on the Buyer's behalf. In any case,

the risks shall transfer to the Buyer upon delivery to the first carrier.

E.3. Without prejudice to the Seller's extraneity in relation to the transport contract, the Seller shall not be indicated as "shipper" on the bill of lading. The communication of the gross weight of the container to the Forwarding agent does not represent in any way the undertaking of any liability by the Seller as regards the SOLAS (Safety Of Life At Sea) Convention. In no event may the said communication be taken to be the VGM (Verified Gross Mass).

E.4. The Buyer undertakes to ensure that the vehicle sent to the Seller's warehouse is suitable for the loading operations, considering the nature of the products. If the vehicle sent to collect the goods causes difficulties in the loading operations, the Seller reserves the right to charge a penalty, of 4% of the value of the products, to cover the extra logistics costs. If the vehicle sent is not at all suitable, the Seller reserves the right to refuse to load the goods and the Buyer shall not have the right to claim compensation for any direct and/or indirect cost that may arise therefrom.

E.5. The Buyer is responsible for assigning the carrier the task of checking the products before loading them; any observations concerning the condition of the packaging and the correspondence of the quantities loaded with those on the transport document must be made by the carrier upon collection of the goods. The said observations must be written on all the copies of the transport documents, otherwise the loaded products shall be considered to be complete and in good condition. As a result, the Seller shall not be liable for any missing or damaged products not reported by the carrier.

E.6. The Buyer is also responsible for assigning the carrier the task of checking the loading procedure and the stability of the goods on the vehicle, in order to prevent damage during transport and to comply with all road safety provisions.

F.- PAYMENTS

F.1. All payments must be made to the Seller's registered office. Payments made to agents, representatives, or sales assistants shall not be considered as made until the amounts are received by the Seller.

F.2. The Buyer shall not fulfil its payment obligations by making payments from countries other than its own country of residence, if the said countries do not guarantee an adequate exchange of information with Italy. In case of breach of the said prohibition, the Seller has the right to terminate the contract for just cause and the Buyer shall not have the right to claim compensation for any damage suffered.

F.3. Any costs for stamp duty and bank draft fees shall be borne by the Buyer. Failure to fulfil, even only in part, the payment shall result in the application of interest on arrears in favour of the Seller, from the date established for the payment, as envisaged by legislative decree 09/10/2002 no. 231.

F.4. Unless otherwise agreed in writing, the Buyer undertakes not to offset any receivables, of whatever nature, owed by the Seller.

G.- CLAIMS

G.1. Upon receipt of the products, the Buyer shall perform a visual inspection in compliance with instructions provided in point 7 of UNI EN ISO 10545-2 standards.

G.2. The products must be installed and fitted strictly respecting the recommendations related to the activities to be performed before and during the laying of the product specified in document 1) Laying, use, cleaning and maintenance manual, published on the Seller's website, and on the product packaging and/or inside the packaging. Faults caused by an incorrect installation and by missing/incorrect maintenance (different from instructions provided in document 1) Laying, use, cleaning and maintenance manual), by an unsuitable use and/or by normal wear over time shall not be considered product faults.

G.3. With the exception of the limits of acceptability foreseen by the international EN 14411 (ISO 13006) standard, the parties acknowledge as identifiable faults those product defects that are immediately visible upon receipt thereof and that make the material unsuitable for use or that significantly reduce its value. This category includes faults as defined in the document 1) Laying, use, cleaning and maintenance manual, published on the Seller's website. Identifiable faults include, by way of a non-limiting example, superficial defects, decoration defects, defects concerning polishing, dimensions, surface flatness, straightness of sides/rectangularity and thickness, cracks, chippings or rough edges, non-compliant shades, mixed shades and products that feature problems deriving from the cutting process and/or from chips.

G.4. If the Buyer finds an identifiable fault, it must be reported in writing to the Seller, within 8 (eight) days from receipt of the products; failure to send the claim shall result

in the forfeiture and loss of such right. The Buyer shall keep the entire lot of material readily available for the Seller. The claim shall include the invoice details and an accurate description of the claimed fault together with photographs, where possible. In the event that the claim proves to be unfounded, the Buyer shall refund the Seller any costs incurred for an inspection (expert's reports, travel, etc.).

G.5. den faults shall be notified to the Supplier in writing, by recorded delivery letter with advice of receipt, within 8 days from the date such fault is found, under penalty of forfeiture.

G.6. The Buyer's right to make a claim for faults under warranty is valid for 12 (twelve) months from the delivery of the products.

H.- WARRANTY FOR FAULTS

H.1. The Seller's warranty is limited to first grade products and not second or third grade products or lots on offer with special prices or discounts, which must be duly specified with a note in the order confirmation.

H.2. The Seller does not guarantee the suitability of the products for particular uses, and only guarantees the technical specifications published on the website in the document 2) Technical data sheets. The indication for use is merely indicative, even when written in the Seller's catalogues and manuals. On the basis of the characteristics described in the document 2) Technical data sheets, the designer always has the task of assessing the suitability of the product for the specific use conditions, taking into account the stress and variables to which the product will be subjected, which may alter its characteristics; for example, the traffic intensity, quality of traffic (foot traffic with the presence of sand, debris...), adverse weather conditions and any other unpredictable factor to which the material may be exposed.

H.3. In the event that identifiable product faults are ascertained, as defined in sub section G no. 3, the Seller shall replace the faulty product with another one with equal or superior characteristics; should this not be possible, the Seller shall apply a significant price reduction. Alternatively, following the return of the faulty products, the Buyer shall have the right to a refund of the price paid plus the transport cost, with the exclusion of compensation for any other direct and/or indirect damage.

H.4. The Seller's warranty shall not be valid if the products that have identifiable faults (totally or in part) have been used and/or in any case transformed, as this entails that the Buyer (or its customer) expressed the intention to accept them in the condition in which they were found.

H.5.- In the event that hidden product faults are ascertained, the Seller's warranty is limited to the replacement with other products of equal or superior characteristics; should this not be possible the Seller shall refund the price paid plus the transport cost. In any case, the Seller's warranty for any direct and/or indirect damage caused by the faulty product, shall be limited to an amount that shall not be greater than double the selling price applied by the Seller, only in relation to the faulty part of the supply.

H.6. In the event that the Buyer resells the product to subjects protected by the consumer code (law decree no. 206/2005), the former shall be responsible for the conditions applied, if different from those stated herein, and shall ensure that the consumer's rights are exercised, in relation to the remedies and terms established by the said code. If there are the grounds for the Buyer to exercise the right of recourse and/or make a claim against the Seller/manufacturer, the said action shall take into account or go beyond the exemptions and limits established in sub sections G no. 1 and H no. 5.

I. SOLVE ET REPETE (pay and then claim) AND TERMINATION CLAUSES

I.1. Pursuant to article 1462 of the Italian Civil Code, on no account may the Buyer suspend or delay payment of collected material, including in the event of alleged defects or faults in the material; this does not affect the right to claim back any payments made unduly (*solve et repete*).

I.2. If the Buyer's financial situation changes or in the event of non-payment (even partial) of products already supplied, the Seller reserves the right to suspend the execution of the supplies underway and/or to terminate the contracts in force and the Buyer shall not have the right to claim direct and/or indirect compensation of any type.

L.- RETENTION OF OWNERSHIP

L.1. The products supplied shall remain exclusive property of the Seller until the Buyer has paid the full amount.

L.2. During the aforementioned period, the Buyer shall undertake the obligations and responsibilities as bailee (also referred to as custodian) and shall not transfer the said products, grant their use, let them be seized or distrained without declaring that the property is of the Seller, and the Buyer shall immediately inform the Seller by recorded delivery letter with advice of receipt.

M.- FORCE MAJEURE

M.1. Each party may suspend the fulfilment of its contractual obligations, when the said fulfilment is impossible or objectively too costly due to an unforeseeable impediment independent from the parties, such as for example: strike, boycott, lockout, fire, war (declared or not), civil war, riots and revolutions, requisitions, embargo, power blackouts, extraordinary breakage of machinery, delays in the delivery of components or raw materials.

M.2. The party that wishes to apply this clause shall immediately notify the onset and end of the circumstances of force majeure to the other party in writing.

M.3. If the suspension due to force majeure lasts longer than 60 (sixty) days, each party shall have the right to terminate this contract, with a notice of 10 (ten) days to be notified to the counterparty in writing.

N.- CONFIDENTIALITY

N.1. The Buyer undertakes to maintain confidentiality as regards all information of a technical (such as, by way of a non-limiting example, drawings, tables, documentation, formulas and correspondence) and commercial nature (including contractual conditions, purchase prices, payment conditions,...) gained during the performance of this contract.

N.2. The confidentiality obligation shall be undertaken for the entire duration of this contract and for the period following its execution.

N.3. In case of failure to uphold the confidentiality obligation, the non-fulfilling party shall pay the other party compensation for all damages that may derive therefrom.

O.- SELLER'S TRADEMARKS AND DISTINCTIVE SIGNS

O.1. The use of trademarks, ornamental designs and creative works in general, in whatever form and manner of expression (such as, by way of a non-limiting example: images, photos, drawings, videos, shapes, structures, etc.) constituting the Seller's intellectual property, through any means (such as, by way of a non-limiting example: press, video, radio, internet, social media, instant messaging platforms or VoIP, etc.) is strictly forbidden. Any exception to the said prohibition, even only partial, must be authorised in writing, each time, by the Seller's general management.

P.- CONTRACT LANGUAGE, APPLICABLE LAW, JURISDICTION AND AUTHORITY

P.1. The present CONTRACT is drafted in Italian, and in case of disputes the said version shall prevail over any translations in other languages.

P.2. Any dispute concerning the supply of products shall be subject to Italian law and jurisdiction and the Court of Modena, the town in which the Seller has its registered office, shall have sole local jurisdiction.

For more information refer to the General Conditions of Sale, available at www.atlasconcorde.com

Condizioni generali di vendita

A.- MODALITA' DI CONCLUSIONE DEL CONTRATTO

A.1. Le presenti Condizioni Generali di Vendita disciplinano ogni contratto di Vendita tra il Venditore e l'Acquirente ed ogni loro modifica o deroga deve essere concordata per iscritto.

A.2. Eventuali offerte, accrediti e/o abbuoni accordati da agenti o da altri intermediari, non sono ritenuti validi se non confermati per iscritto dal Venditore.

A.3. L'Acquirente invia al Venditore, direttamente o per il tramite di agenti, Ordini scritti che devono contenere l'indicazione dei codici dei Prodotti richiesti, delle quantità, del loro prezzo e della destinazione. L'Ordine inviato dall'Acquirente è irrevocabile.

A.4. La Vendita dovrà ritenersi conclusa nel momento in cui: (i) l'Acquirente riceva da parte del Venditore una Conferma scritta via e-mail, fax o altri mezzi telematici, conforme ai termini e alle condizioni dell'Ordine; o (ii) in caso di Conferma inviata dal Venditore contenente condizioni difformi dall'Ordine ricevuto dall'Acquirente quando questi l'accetti per iscritto o comunque non la contesti entro 7 (sette) giorni dalla ricezione; o (iii) in assenza di conferma scritta da parte del Venditore, nel momento in cui i Prodotti saranno consegnati e caricati dall'Acquirente.

A.5. L'Acquirente condivide l'esigenza di limitare al territorio nazionale le vendite di prodotti Atlas Concorde.

Il Venditore ritiene questa regola elemento indispensabile per permettergli di coordinare la sua politica commerciale e razionalizzare la rete distributiva, con offerte più orientate alle necessità dei singoli Paesi.

Parimenti, l'Acquirente riconosce che tale esigenza costituisce una tutela anche dei propri interessi.

L'Acquirente si obbliga quindi a commercializzare i prodotti forniti da Ceramiche Atlas Concorde SpA esclusivamente nel suo Paese di residenza, astenendosi dal promuovere vendite attive sollecitate anche online con clienti situati nel territorio di uno Stato diverso dal proprio.

Per le operazioni triangolari il presente obbligo si applica al Paese di effettiva operatività dell'acquirente.

L'Acquirente potrà rivendere il prodotto al di fuori dal proprio territorio nel caso in cui riceva autorizzazione per iscritto da parte del Venditore, o nel caso in cui la rivendita riguardi prodotti non di prima scelta, oppure prodotti fuori produzione.

B.- PREZZI

B.1. Salvo diversa pattuizione scritta, i prezzi di vendita concordati di volta in volta si intendono al netto per contanti e per consegna franco stabilimento del Venditore indicato nella Conferma d'Ordine.

C.- CARATTERISTICHE DEI PRODOTTI

C.1. L'Acquirente dichiara di aver preso visione ed attenersi al contenuto della seguente documentazione pubblicata nel sito internet aziendale: 1) Manuale di Posa, Uso, Pulizia e Manutenzione e 2) Schede tecniche.

C.2. Data la intrinseca variabilità del prodotto ceramico, le caratteristiche dei campioni e/o modelli inviati in precedenza dal Venditore all'Acquirente sono da considerarsi indicativi e non vincolanti.

C.3. Salvo specifiche richieste da concordare prima della Conferma d'Ordine, il Venditore non garantisce che l'ordine del singolo articolo venga evaso tutto con un medesimo lotto di produzione.

D.- TERMINI DI CONSEGNA

D.1. I termini di consegna sono da intendersi indicativi e la proroga di essi non può far maturare all'Acquirente alcun diritto a richiedere indennizzi, ogni eccezione rimossa.

D.2. Se, trascorsi 10 (dieci) giorni dalla data di avviso di merce pronta, l'Acquirente non ritira il materiale, il Venditore si riserva di stabilire discrezionalmente un nuovo termine di consegna.

E.- RESA E SPEDIZIONE

E.1. L'eventuale variazione della destinazione dei Prodotti, diversa da quella concordata in Conferma d'Ordine, deve essere comunicata dall'Acquirente per iscritto entro e non oltre il secondo giorno antecedente a quello previsto per il ritiro presso la sede del Venditore. Il Venditore si riserva la facoltà di non accettare la variazione della destinazione dei Prodotti. Nel caso si verifichi che la destinazione effettiva del Prodotto sia stata diversa da quella dichiarata dall'Acquirente, il Venditore si riserva la facoltà di sospendere l'esecuzione delle forniture in corso e/o risolvere i contratti in corso senza che l'Acquirente possa rivendicare risarcimenti diretti e/o indiretti di alcun tipo.

E.2. Salvo patto contrario, la fornitura della merce si intende Franco Fabbrica (EXW

ai sensi degli Incoterms 2010) e ciò anche quando sia convenuto che la spedizione o parte di essa venga curata dal Venditore su mandato dell'Acquirente. In ogni caso i rischi passano all'Acquirente al più tardi con la consegna al primo trasportatore.

E.3. Ferma restando l'estraneità del Venditore rispetto al contratto di trasporto, il Venditore non potrà essere indicato come "shipper" nella polizza di carico. La comunicazione del peso lordo del container allo spedizioniere, non costituisce alcuna assunzione di responsabilità da parte del Venditore ai fini della Convenzione SOLAS (Safety Of Life At Sea). In nessun caso tale comunicazione potrà essere intesa come VGM (Verified Gross Mass).

E.4. L'Acquirente s'impegna affinché il mezzo inviato presso i magazzini del Venditore sia idoneo al carico in relazione alla natura dei Prodotti. Nel caso il mezzo che si presenta comporti significative difficoltà per le operazioni di carico, il Venditore si riserva di addebitare una penale pari al 4% del valore dei prodotti a copertura dei maggiori costi logistici. Se il mezzo convenuto non è assolutamente idoneo, il Venditore si riserva la facoltà di negare le operazioni di carico senza che nulla possa essere richiesto dall'Acquirente a titolo di risarcimento per ogni onere diretto e/o indiretto che ne possa derivarne.

E.5. È compito dell'Acquirente incaricare il vettore di controllare i prodotti prima del carico; eventuali osservazioni in relazione all'integrità degli imballi e della rispondenza delle quantità caricate a quelle indicate sul documento di trasporto, devono essere sollevate dal vettore al momento del carico. Tali osservazioni devono essere riportate su tutte le copie dei documenti di trasporto, altrimenti i prodotti caricati s'intendono integri e completi. Ne deriva che il Venditore non si assume alcuna responsabilità in relazione a mancanze o danni dei prodotti non segnalati dal vettore.

E.6. È altresì responsabilità dell'Acquirente incaricare il vettore di verificare le modalità e la stabilità del carico sul mezzo affinché durante il trasporto non si verifichino rotture e affinché siano rispettate tutte le disposizioni di sicurezza riguardanti la circolazione stradale.

F.- PAGAMENTI

F.1. Qualsiasi obbligazione di pagamento deve essere adempiuta presso la sede legale del Venditore. Eventuali pagamenti ad agenti, rappresentanti o ausiliari di commercio non si intendono effettuati finché le relative somme non pervengono al Venditore.

F.2. E' fatto divieto all'Acquirente di eseguire il proprio adempimento mediante pagamenti provenienti da paesi diversi dal proprio paese di residenza se trattasi di paesi che non garantiscono un adeguato scambio di informazioni con l'Italia. In caso di violazione di tale divieto, il Venditore ha facoltà di risolvere il contratto per giusta causa senza che l'Acquirente possa vantare il diritto di ottenere alcun risarcimento per l'eventuale danno subito.

F.3. Eventuali spese di bollo ed incasso effetti e tratte sono a carico dell'Acquirente. In caso di inadempimento, anche solo parziale, dal giorno fissato per il pagamento decorreranno a favore del Venditore gli interessi moratori nella misura prevista dal d.lgs. 09/10/2002 n. 231.

F.4. Salvo diversi accordi scritti, l'Acquirente si impegna a non compensare alcun credito, comunque insorto, nei confronti del Venditore.

G.- RECLAMI

G.1. Al ricevimento dei Prodotti, l'Acquirente dovrà sottoporli ad accurato controllo attraverso un esame visivo effettuato conformemente alle indicazioni riportate al punto 7 delle norme UNI EN ISO 10545-2.

G.2. L'installazione e la posa dei Prodotti deve essere effettuata attenendosi scrupolosamente alle raccomandazioni inerenti le attività da svolgere prima e durante la posa in opera indicate nel documento 1) Manuale di Posa, Uso, Pulizia e Manutenzione pubblicato nel sito internet del Venditore e sulla confezione del prodotto e/o all'interno della stessa. Non sono considerati vizi del Prodotto quelli generati da un'errata installazione e dalla mancata/errata manutenzione (difformi dalle indicazioni fornite nel 1) Manuale di Posa, Uso, Pulizia e Manutenzione), da una non idonea destinazione d'uso e/o dalla normale usura nel tempo.

G.3. Fatti salvi i limiti di accettabilità previsti dalla norma internazionale EN 14411 (ISO 13006), le Parti riconoscono come Vizi Palesi i difetti dei Prodotti riscontrabili già al momento del loro ricevimento tali da rendere il materiale inidoneo all'uso o da diminuirne in modo apprezzabile il valore. Rientrano in tale categoria i difetti come definiti nel documento 1) Manuale di Posa, Uso, Pulizia e Manutenzione pubblicato nel sito internet del Venditore. A titolo esemplificativo e non esaustivo si riconoscono

come Vizi Palesi i difetti superficiali, i difetti di decorazione, di lappatura/levigatura, di calibro, di planarità, di ortogonalità-rettilineità, di spessore, le crepe, le sbecature, i fuori tono, i toni mescolati e i Prodotti che presentano problemi da taglio/scaglie.

G.4. Nel caso l'Acquirente rilevi Vizi Palesi dovrà fare reclamo al Venditore per iscritto, a pena di decadenza, entro 8 (otto) giorni dal ricevimento e tenere a disposizione del Venditore l'intera partita di materiale. Il reclamo dovrà riportare i dati di fatturazione e una precisa descrizione del vizio reclamato corredata, quando possibile, da immagini fotografiche. Qualora il reclamo dovesse risultare infondato, l'Acquirente si rende disponibile a risarcire il Venditore delle spese sostenute per l'eventuale sopralluogo (perizie, viaggi ecc.).

G.5. I Vizi Occulti dovranno essere notificati al Venditore mediante lettera raccomandata A.R., a pena di decadenza dalla garanzia, entro 8 (otto) giorni dalla data della scoperta del difetto.

G.6. L'azione dell'Acquirente diretta a fare valere la garanzia per vizi si prescrive comunque nel termine di 12 (dodici) mesi decorrenti dalla consegna dei Prodotti.

H.- GARANZIA PER VIZI

H.1. La garanzia del Venditore si intende limitata ai soli Prodotti di prima scelta e non ai Prodotti di seconda o terza scelta o di partite d'occasione con prezzi o sconti particolari quando debitamente segnalati in nota nella Conferma dell'Ordine.

H.2. Il Venditore non garantisce l'idoneità dei Prodotti ad usi particolari, ma soltanto le caratteristiche tecniche pubblicate nel sito internet nel documento 2) Schede tecniche. L'indicazione d'uso, anche quando presentata dal Venditore in cataloghi e manuali, è da ritenersi puramente indicativa. Sulla base delle caratteristiche tecniche riportate nelle 2) Schede Tecniche è sempre compito del progettista valutare l'idoneità del Prodotto alle condizioni specifiche di utilizzo in funzione delle sollecitazioni e delle variabili che si possono verificare nell'ambiente di destinazione alterandone le sue caratteristiche, a titolo d'esempio, all'intensità del traffico, alla qualità del traffico (calpestio in presenza di sabbia, di detriti...), alle eventuali condizioni climatiche avverse e a qualsiasi altra aleatorietà a cui può essere esposto il materiale.

H.3. Nel caso risulti accertato che il Prodotto manifesti Vizi Palesi, come definiti al sub lett. G n.3, il Venditore provvederà alla sostituzione del Prodotto difettoso con altro avente caratteristiche pari o superiori o nel caso ciò non sia possibile ad una congrua riduzione del prezzo. In alternativa l'Acquirente avrà diritto, previa restituzione dei Prodotti viziati, al rimborso del prezzo pagato, maggiorato del costo del trasporto, con esclusione del risarcimento di ogni altro danno diretto e/o indiretto.

H.4. La garanzia del Venditore deve ritenersi esclusa nel caso in cui il Prodotto affetto da Vizi Palesi (in tutto o in parte) sia stato utilizzato e/o comunque trasformato dovendosi ritenere che in tal modo l'Acquirente (o il suo cliente) abbia espresso la volontà di accettarli nello stato in cui si trovano.

H.5. Nel caso risulti accertato che il Prodotto manifesti Vizi Occulti, la garanzia del Venditore è limitata alla sostituzione del materiale con altro avente caratteristiche pari o superiori e ove ciò non sia possibile al rimborso del prezzo pagato maggiorato del costo del trasporto. In ogni caso la garanzia del Venditore per ogni danno diretto e/o indiretto comunque originato dal prodotto difettoso, deve intendersi limitata ad una somma che non potrà superare il doppio del prezzo di vendita applicato dal Venditore in relazione alla sola parte della fornitura difettosa.

H.6. Nel caso l'Acquirente rivenda il Prodotto a soggetti tutelati dal codice del consumo (d.l. n.206/2005) sarà responsabile delle condizioni praticate se difformi da quelle qui riportate e dovrà accertarsi che i diritti del consumatore siano esercitati nel rispetto dei rimedi e dei termini fissati da tale codice. Nel caso sussistano i presupposti, il diritto di regresso e/o comunque di rivalsa spettanti all'Acquirente verso il Venditore/produttore non potrà eccedere le esenzioni ed i limiti come fissati dal sub lett. G n.1 al sub lett. H n.5.

I. CLAUSOLE SOLVE ET REPETE E RISOLUTIVE

I.1. Ai sensi dell'art. 1462 del Codice Civile, per nessun motivo, ivi compresi pretesi vizi o difetti del materiale, l'Acquirente potrà sospendere o ritardare il pagamento del materiale ritirato, salva naturalmente la facoltà di ripetere quando possa dimostrare di avere indebitamente pagato.

I.2. Nel caso di mutamento delle condizioni patrimoniali dell'Acquirente o di mancato pagamento anche parziale di prodotti già forniti, il Venditore può sospendere

l'esecuzione delle forniture in corso e/o risolvere i contratti in corso senza che l'Acquirente possa rivendicare risarcimenti diretti e/o indiretti di alcun tipo.

L.- PATTO DI RISERVATO DOMINIO

L.1. Fino a quando l'Acquirente non avrà provveduto all'integrale pagamento del prezzo, i Prodotti oggetto della fornitura rimarranno di proprietà del Venditore.

L.2. Durante il periodo suddetto, l'Acquirente assumerà gli obblighi e le responsabilità del custode, e non potrà alienare, dare in uso, lasciare sequestrare o pignorare tali Prodotti senza dichiarare la proprietà del Venditore e dare immediato avviso a mezzo raccomandata A.R.

M.- FORZA MAGGIORE

M.1. Ciascuna parte potrà sospendere l'esecuzione dei suoi obblighi contrattuali quando tale esecuzione sia resa impossibile o oggettivamente troppo onerosa da un impedimento imprevedibile indipendente dalla sua volontà, quale ad esempio: sciopero, boicottaggio, serrata, incendio, guerra (dichiarata o non), guerra civile, sommosse e rivoluzioni, requisizioni, embargo, interruzioni di energia, rotture straordinarie di macchinari, ritardi nella consegna di componenti o materie prime.

M.2. La parte che desidera avvalersi della presente clausola dovrà comunicare immediatamente per iscritto all'altra parte il verificarsi e la cessazione delle circostanze di forza maggiore.

M.3. Qualora la sospensione dovuta a forza maggiore duri più di 60 (sessanta) giorni, ciascuna parte avrà il diritto di risolvere il presente contratto, previo un preavviso di 10 (dieci) giorni, da comunicarsi alla controparte per iscritto.

N.- OBBLIGO DI RISERVATEZZA

N.1. L'Acquirente è tenuto ad osservare la più assoluta riservatezza su tutte le notizie di carattere tecnico (quali, in via meramente esemplificativa, disegni, prospetti, documentazioni, formule e corrispondenza) e di carattere commerciale (ivi comprese le condizioni contrattuali, i prezzi d'acquisto, le condizioni di pagamento ...) apprese in esecuzione del presente Contratto.

N.2. L'obbligo di riservatezza viene assunto per tutta la durata del Contratto, nonché per il periodo successivo alla sua esecuzione.

N.3. In ogni caso di inosservanza dell'obbligo di riservatezza, la parte inadempiente è tenuta e risarcire all'altra tutti i danni che ne dovessero derivare.

O.- MARCHI E SEGNI DISTINTIVI DEL VENDITORE

O.1. L'utilizzo dei marchi, dei modelli ornamentali e delle opere d'ingegno in genere, in qualunque forma o modo di espressione (quali a titolo meramente esemplificativo, ma non esaustivo: immagini, foto, disegni, filmati, figure, strutture, etc.) costituenti proprietà intellettuale del Venditore, attraverso qualsiasi mezzo (quali a titolo meramente esemplificativo, ma non esaustivo: stampa, video, radio, internet, social media, piattaforme di messaggistica istantanea o VoIP, etc.) è severamente vietato. Qualsiasi deroga a tale divieto, anche solamente parziale, dovrà essere autorizzata per iscritto, caso per caso, dalla Direzione generale del Venditore.

P.- LINGUA DEL CONTRATTO, LEGGE APPLICABILE, GIURISDIZIONE E COMPETENZA

P.1. Il Contratto e le presenti condizioni sono redatti in lingua Italiana, la quale prevarrà nel caso di divergenza con la traduzione in altre lingue.

P.2. La definizione di qualsiasi controversia comunque relativa alle forniture è soggetta alla legge ed alla giurisdizione dello Stato Italiano e la competenza territoriale viene devoluta in via esclusiva al Tribunale di Modena nella cui circoscrizione il Venditore ha la sua sede legale.

Per maggiori informazioni riferirsi alle Condizioni Generali di Vendita, disponibili all'indirizzo www.atlasconcorde.com

Conditions générales de vente

A.- MODALITÉS DE CONCLUSION DU CONTRAT

A.1. Les présentes Conditions Générales de Vente régissent tout contrat de Vente entre le Vendeur et l'Acheteur et toute modification ou dérogation de ces dernières doit être convenue par écrit.

A.2. D'éventuelles offres, accréditations et / ou ristournes accordées par des agents ou par d'autres intermédiaires, ne seront réputées valables que si elles sont confirmées par écrit par le Vendeur.

A.3. L'Acheteur envoie au Vendeur, directement ou par l'intermédiaire d'agents, des Commandes écrites qui doivent indiquer les codes des Produits demandés, les quantités, leur prix et leur destination. La commande envoyée par l'Acheteur est irrévocable.

A.4. La Vente doit être réputée conclue au moment où : (i) l'Acheteur reçoit de la part du Vendeur une Confirmation écrite par e-mail, par télécopie ou par d'autres moyens télématiques, conforme aux conditions de la Commande ; ou (ii) en cas de Confirmation envoyée par le Vendeur contenant des conditions différant de la Commande envoyée par l'Acheteur lorsque celui-ci l'accepte par écrit ou quoi qu'il en soit s'il ne la conteste pas dans un délai de 7 (sept) jours à compter de la réception ; ou (iii) en l'absence d'une confirmation écrite de la part du Vendeur, au moment où les Produits seront livrés et chargés par l'Acheteur.

A.5. L'Acheteur partage l'exigence de limiter les ventes de produits Atlas Concorde au territoire national.

Le Vendeur considère cette règle comme un élément indispensable lui permettant de coordonner sa politique commerciale et de rationaliser le réseau de distribution, avec des offres davantage orientées vers les exigences des différents Pays.

De même, l'Acheteur reconnaît que cette exigence constitue également une mesure de protection de ses propres intérêts.

L'Acheteur s'engage donc à commercialiser les produits fournis par Ceramiche Atlas Concorde SpA exclusivement dans son Pays de résidence, en s'abstenant de promouvoir les ventes actives également sollicitées en ligne auprès de clients situés sur le territoire d'un État différent du sien.

Pour les opérations triangulaires, la présente obligation s'applique au pays dans lequel l'acheteur opère effectivement.

L'Acheteur pourra revendre le produit hors de son territoire avec l'autorisation écrite du Vendeur, ou si la revente concerne des produits qui ne sont pas de premier choix ou des produits hors production.

B.- PRIX

B.1. Sauf accord contraire, les prix de vente convenus au fur et à mesure sont réputés nets, pour les paiements en espèces et les livraisons Franco l'établissement du Vendeur indiqué sur la Confirmation de Commande.

C.- CARACTÉRISTIQUES DES PRODUITS

C.1. L'Acheteur déclare avoir lu et s'en tenir au contenu de la documentation suivante publiée sur le site Internet de la société: 1) Manuel de Pose, d'Utilisation, de Nettoyage et d'Entretien et 2) Fiches techniques.

C.2. Vu la variabilité intrinsèque du produit en céramique, les caractéristiques des échantillons et / ou des modèles envoyés précédemment par le Vendeur à l'Acheteur sont indicatifs et non contraignants.

C.3. Sauf en cas de demandes spécifiques à convenir avant la Confirmation de Commande, le Vendeur ne garantit pas la commande d'un article soit intégralement constituée par un même lot de production.

D.- DÉLAIS DE LIVRAISON

D.1. Les délais de livraison s'entendent fournis à titre indicatif et leur prorogation ne donne en aucun cas le droit à l'Acheteur de demander des indemnisations, excluant dès à présent toute exception.

D.2. Si l'Acheteur ne retire pas le matériel, au bout d'un délai de 10 (dix) jours à compter de la date de l'annonce indiquant que la marchandise est prête, le Vendeur se réserve la faculté de fixer à sa discrétion un nouveau délai de livraison.

E.- LIVRAISON ET EXPÉDITION

E.1. L'éventuelle variation de la destination des Produits, différente de celle convenue dans la Confirmation de Commande, doit être communiquée par l'Acheteur par écrit au plus tard le second jour qui précède le jour du retrait au siège du Vendeur. Le Vendeur se réserve la faculté de ne pas accepter la variation de la destination des Produits. Au cas où la destination effective du Produit serait différente de celle déclarée par

l'Acheteur, le Vendeur se réserve la faculté de suspendre l'exécution des fournitures en cours et / ou de résilier le contrat sans que l'Acheteur puisse revendiquer des indemnisations directes et / ou indirectes d'aucune sorte.

E.2. Sauf accord contraire, la fourniture de la marchandise est livrée Départ Usine (EXW aux termes des Incoterms 2010) même si l'on a convenu que l'expédition ou une partie de cette dernière sera suivie par le Vendeur sur mandat de l'Acheteur. En tout état de cause, les risques passent à l'Acheteur au plus tard au moment de la livraison au premier transporteur.

E.3. Sans préjudice du désintérêt du Vendeur par rapport au contrat de transport, celui-ci ne pourra être indiqué comme le “shipper” dans le connaissance. La communication du poids brut du container à l'expéditeur, ne constitue pas une prise de responsabilité de la part du Vendeur aux fins de la Convention SOLAS (Safety Of Life At Sea). En aucun cas cette communication ne pourra être considérée comme le VGM (Verified Gross Mass).

E.4. L'Acheteur s'engage à ce que le véhicule envoyé aux entrepôts du Vendeur soit compatible avec la nature des Produits à charger. Si le véhicule qui se présente comporte des difficultés significatives pour les opérations de chargement, le Vendeur se réserve la faculté de débiter une pénalité de l'ordre de 4 % de la valeur des produits pour couvrir les coûts logistiques supplémentaires. Si le véhicule convenu n'est absolument pas compatible, le Vendeur se réserve la faculté de refuser les opérations de chargement sans que l'Acheteur ne puisse rien lui demander à titre de remboursement de toute dépense directe et / ou indirecte éventuelle.

E.5. Il appartient à l'Acheteur de charger le transporteur de contrôler les produits avant le chargement ; d'éventuelles observations concernant l'intégrité des emballages et la correspondance des quantités chargées avec celles indiquées sur le document de transport doivent être soulevées par le transporteur au moment du chargement. Ces observations doivent être indiquées sur toutes les copies des documents de transport ; dans le cas contraire, les produits chargés sont réputés intacts et complets. Il s'ensuit que le Vendeur décline toute responsabilité en cas d'absence ou de détérioration des produits non signalée par le transporteur.

E.6. L'Acheteur a également la responsabilité de charger le transporteur de vérifier les modalités et la stabilité du chargement sur le véhicule afin d'éviter les bris durant le transport et le respect de toutes les dispositions de sécurité concernant la circulation sur route.

F.- PAIEMENTS

F.1. Toute obligation de paiement doit être accomplie au siège légal du Vendeur. Les éventuels paiements remis à des agents, à des représentants ou à des auxiliaires de commerce ne seront réputés effectués qu'au moment où le Vendeur percevra les sommes correspondantes.

F.2. Il est interdit à l'Acheteur d'effectuer des paiements depuis un pays différent de son pays de résidence et ne garantissant pas un échange d'informations correct avec l'Italie. En cas de violation de cette interdiction, le Vendeur a la faculté de résilier le contrat pour juste cause sans que l'Acheteur ne puisse revendiquer le droit d'obtenir une quelconque réparation pour l'éventuel préjudice subi.

F.3. Les éventuels frais de timbre et d'encaissement d'effets et de traites sont à la charge de l'Acheteur. En cas de défaillance, même partielle, des intérêts de retard commencent à courir en faveur du Vendeur, à compter du jour fixé pour le paiement, dans la mesure prévue par le Décret Législatif italien n° 231 du 09/10/2002.

F.4. Sauf accord écrit contraire, l'Acheteur s'engage à ne compenser aucune créance échue.

G.- RÉCLAMATIONS

G.1. À la réception des Produits, l'Acheteur devra soumettre ces derniers à un contrôle minutieux moyennant un examen visuel effectué conformément aux indications du point 7 des normes UNI EN ISO 10545-2.

G.2. L'installation et la pose des Produits doivent être effectuées en suivant scrupuleusement les recommandations inhérentes aux activités exercées avant et durant la pose indiquées sur le document 1) Manuel de Pose, d'Utilisation, de Nettoyage et d'Entretien, publié sur le site Internet du Vendeur ainsi qu'à l'extérieur et/ ou à l'intérieur de l'emballage du produit. Les défauts dus à une installation erronée et à un entretien absent / erroné (ne respectant pas les indications fournies dans le 1) Manuel de Pose, d'Utilisation, de Nettoyage et d'Entretien), par un usage prévu inapproprié et / ou par l'usure normale due au temps ne sont pas considérés comme des vices du Produit.

G.3. Sous réserve des limites d'acceptabilité prévues par la norme internationale EN 14411 (ISO 13006), les Parties reconnaissent comme des Vices Évidents les défauts des Produits existant dès la réception de sorte que le matériel devienne inutilisable ou qu'il perde une grande partie de sa valeur. Cette catégorie comprend les défauts définis dans le document 1) Manuel de Pose, d'Utilisation, de Nettoyage et d'Entretien publié sur le site Internet du Vendeur. À titre d'exemple non contraignant, on reconnaît comme des Vices Évidents les défauts de surface, de décoration, de polissage, de calibre, de planéité, d'orthogonalité–rectitude, d'épaisseur, les fissures, les ébréchés, les hors nuance, les nuances mélangées et les Produits qui présentent des problèmes de coupe - voile.

G.4. Si l'Acheteur relève des Vices Évidents, il devra présenter une réclamation écrite au Vendeur, sous peine de déchéance, dans un délai de 8 (huit) jours à compter de la réception et tenir le lot complet de matériel à la disposition de ce dernier. La réclamation devra indiquer les données de facturation et une description précise du vice objet de la réclamation, accompagnée, si possible, de photographies. Si la réclamation devait s'avérer sans fondement, l'Acheteur est disposé à rembourser au Vendeur les dépenses encourues pour l'éventuelle visite des lieux (expertises, déplacements, etc.).

G.5. Les Vices Cachés devront être notifiés au Vendeur par lettre recommandée avec avis de réception, sous peine d'annulation de la garantie, dans un délai de 8 (huit) jours à compter de la date de la découverte du défaut.

G.6. L'action de l'Acheteur ayant pour but de faire valoir la garantie en cas de vices se prescrit dans un délai de 12 (douze) mois à compter de la livraison des Produits.

H.- GARANTIE COUVRANT LES VICES

H.1. La garantie du Vendeur est réputée limitée aux seuls Produits de premier choix et non aux Produits de second ou de troisième choix ou à des lots d'occasion auquel on applique des prix ou des remises particuliers lorsqu'ils sont dûment signalés dans les notes de la Confirmation de Commande.

H.2. Le Vendeur ne garantit pas l'adéquation des Produits à des usages particuliers, mais uniquement les caractéristiques techniques publiées sur le site Internet dans le document 2) Fiches techniques. L'usage indiqué, également lorsqu'il est présenté par le Vendeur dans des catalogues et des manuels, est purement indicatif. Sur la base des caractéristiques techniques indiquées dans les 2) Fiches Techniques, le concepteur a toujours le devoir d'évaluer l'adéquation du Produit aux conditions spécifiques d'utilisation en fonction des contraintes et des variables pouvant se vérifier dans le lieu de destination et susceptibles d'en altérer les caractéristiques, par exemple, l'intensité et la qualité de la circulation (piètement en présence de sable, de détritrus...), ainsi que les éventuelles conditions climatiques défavorables et toute autre incidence à laquelle peut être exposé le matériel.

H.3. Si l'on a constaté que le Produit présente les Vices Évidents définis à la lettre G n°3, le Vendeur remplacera le Produit défectueux par un autre produit ayant des caractéristiques analogues ou supérieures ou, lorsque cela est impossible, à une réduction cohérente du prix. En alternative, l'Acheteur aura droit, après la restitution des Produits défectueux, au remboursement du prix payé, majoré du prix du transport, à l'exclusion du remboursement de tout autre préjudice direct et / ou indirect.

H.4. La garantie du Vendeur doit être réputée exclue au cas où le Produit présentant des Vices Évidents (entièrement ou partiellement) aurait été utilisé et / ou du moins transformé ; dans ce cas, on considérera que l'Acheteur (ou son client) a exprimé la volonté de les accepter en l'état.

H.5 Si l'on a constaté que le Produit présente des Vices Cachés, la garantie du Vendeur se limite au remplacement du matériel par du matériel ayant des caractéristiques analogues ou supérieures et, lorsque cela est impossible, au remboursement du prix payé majoré des frais de transport. En tout état de cause, la garantie du Vendeur couvrant tout dommage direct et / ou indirect causé par le produit défectueux, se limitera à une somme qui ne pourra pas dépasser le double du prix de vente appliqué par le Vendeur dans le cadre de la seule partie de la fourniture défectueuse.

H.6. Si l'Acheteur revend le Produit à des clients protégés par le code de la consommation (Décret–loi italien n° 206/2005) il sera responsable des conditions appliquées si celles-ci diffèrent des conditions indiquées ici et il devra s'assurer que les droits du consommateur sont exercés dans le respect des remèdes et des délais fixés par ce code. Si les conditions sont réunies, le droit de retrait et / ou de recours

revenant à l'Acheteur à l'encontre du Vendeur / fabricant ne pourra dépasser ni les exonérations ni les limites établies de la lettre G n°1 à la lettre H n°5.

I. CLAUSES SOLVE ET REPETE ET CLAUSES RÉSOLUTOIRES

I.1. Aux termes de l'art. 1462 du Code Civil italien, en aucun cas, y compris les prétendus vices ou défauts du matériel, l'Acheteur ne pourra suspendre ou retarder le paiement du matériel retiré, sans préjudice naturellement de la faculté d'exiger lorsqu'il est en mesure de démontrer avoir indûment payé.

I.2. En cas de variation des conditions patrimoniales de l'Acheteur ou de non-paiement même partiel de produits déjà fournis, le Vendeur se réserve la faculté de suspendre l'exécution des fournitures en cours et / ou de résilier les contrats sans que l'Acheteur ne puisse revendiquer des indemnisations directes et / ou indirectes d'aucune sorte.

L.- PACTE DE RÉSERVE DE PROPRIÉTÉ

L.1. Tant que l'Acheteur n'aura pas intégralement payé le prix, les Produits objet de la fourniture resteront la propriété du Vendeur.

L.2. Au cours de la susdite période, l'Acheteur assumera les obligations et les responsabilités de gardien, et il ne pourra ni aliéner, ni confier, ni permettre la saisie

desdits Produits sans déclarer la propriété du Vendeur et informer immédiatement ce dernier par lettre recommandée avec avis de réception.

M.- FORCE MAJEURE

M.1. Chacune des parties pourra suspendre l'accomplissement de ses obligations contractuelles lorsque cette exécution est rendue impossible ou objectivement trop onéreuse par un empêchement imprévisible indépendant de sa volonté comme : les grèves, les boycottages, les lock-outs, les incendies, les guerres (déclarées ou non), les guerres civiles, les révoltes et les révolutions, les réquisitions, les embargos, les coupures de courant, les ruptures exceptionnelles de machines, les retards de livraison de composants ou de matières premières.

M.2. La partie qui souhaite user de la présente clause devra communiquer immédiatement par écrit à l'autre partie la survenue et la cessation des circonstances de force majeure.

M.3. Si la suspension due à une force majeure dure plus de 60 (soixante) jours, chacune des parties aura le droit de résilier le présent contrat, avec un préavis de 10 (dix) jours, en le communiquant par écrit à la partie adverse.

N.- OBLIGATIONS DE CONFIDENTIALITÉ

N.1. L'Acheteur est tenu d'observer le secret le plus absolu concernant toutes les informations de caractère technique (comme, par exemple, les dessins, les notices, les documentations, les formules et la correspondance) et de caractère commercial (y compris les conditions contractuelles, les prix d'achat, les conditions de paiement, etc.) dont il aurait eu connaissance durant l'exécution du présent Contrat.

N.2. L'obligation de confidentialité est assumée pendant toute la durée du Contrat, ainsi que pour la période successive à son exécution.

N.3. Dans tous cas de non–observation de l'obligation de confidentialité, la partie défaillante est tenue de réparer à l'autre partie tous les éventuels préjudices.

O.- MARQUES ET SIGNES DISTINCTIFS DU VENDEUR

O.1. L'utilisation des marques, des modèles ornementaux et des œuvres de l'esprit en général, sous quelque forme ou suivant quelque modalité d'expression que ce soit (à titre d'exemple, non contraignant : les images, les photos, les dessins, les vidéos, les figures, les structures, etc.) constituant la propriété intellectuelle du Vendeur, à travers tout moyen (à titre d'exemple non contraignant : l'impression, la vidéo, la radio, Internet, les médias sociaux, les plates-formes de messagerie instantanée ou VoIP, etc.) est formellement interdite. Toute dérogation à cette interdiction, même partielle, devra être autorisée par écrit, cas par cas, par la Direction générale du Vendeur.

P.- LANGUE DU CONTRAT, LOI APPLICABLE, JURIDICTION ET COMPÉTENCE

P.1. Le Contrat et les présentes conditions sont rédigés en langue italienne qui prévaudra en cas de divergence avec la traduction dans d'autres langues.

P.2. La définition de toute controverse relative aux fournitures est régie par la loi et la juridiction de l'État italien et les parties reconnaissent la compétence territoriale exclusive du Tribunal de Modène dans la circonscription duquel se trouve le siège légal du Vendeur.

Pour plus de renseignements, consulter les Conditions générales de vente qui sont disponibles à l'adresse www.atlasconcorde.com

Allgemeine Verkaufsbedingungen

A.- MODALITÄT DES VERTRAGSABSCHLUSSES

A.1. Die vorliegenden Allgemeinen Verkaufsbedingungen regeln alle Verträge zwischen dem Verkäufer und dem Käufer und alle Änderungen oder Abweichungen davon müssen schriftlich vereinbart werden.

A.2. Eventuelle Angebote sowie mit Handelsvertretern oder sonstigen Vermittlern vereinbarten Gutschriften sind nicht verbindlich, es sei denn, sie werden vom Verkäufer schriftlich bestätigt.

A.3. Der Käufer sendet dem Verkäufer direkt oder über Handelsvertreter schriftliche Bestellungen zu, die die Angabe der Artikelnummern der gewünschten Produkte, der Mengen, ihres Preises und der Bestimmung enthalten müssen. Die vom Käufer gesendete Bestellung ist unwiderruflich.

A.4. Der Verkauf gilt zu dem Zeitpunkt als abgeschlossen, an dem: (i) der Käufer vom Verkäufer eine schriftliche Bestätigung per E-Mail, Fax oder auf sonstigem Weg erhält, die den Fristen und Bedingungen der Bestellung entspricht; oder (ii) falls die vom Verkäufer gesendete Bestätigung, Bedingungen enthält, die von der vom Käufer erhaltenen Bestellung abweichen, wenn dieser diese akzeptiert oder nicht innerhalb von 7 (sieben) Tagen ab ihrem Empfang beanstandet; oder (iii) falls keine schriftliche Bestätigung durch den Verkäufer erfolgt, zu dem Zeitpunkt, an dem die Produkte geliefert und vom Käufer übernommen werden.

A.5. Der Käufer teilt die Notwendigkeit, das nationale Gebiet für die Verkäufe der Produkt von Atlas Concorde zu unterteilen. Der Verkäufer hält diese Regel für ein unverzichtbares Element, um es ihm zu gestatten, seine kommerzielle Politik zu koordinieren und sein Vertriebsnetz mit Angeboten für die Erfordernisse der einzelnen Länder zu rationalisieren. Außerdem erkennt der Käufer an, dass diese Notwendigkeit auch zum Schutz der eigenen Interessen dient. Der Käufer verpflichtet sich daher, die von Ceramiche Atlas Concorde SpA gelieferten Produkte ausschließlich in dem Land zu vertreiben, in dem er seinen Firmensitz hat, und den aktiven Verkauf – auch online – an Kunden mit Sitz in einem anderen Staat zu unterlassen. Für Dreiecksgeschäfte wird die vorliegende Pflicht auf das Land angewendet, in dem der Käufer effektiv tätig ist. Der Käufer kann das Produkt außerhalb seines eigenen Gebiets verkaufen, falls er die schriftliche Genehmigung des Verkäufers einholt, oder falls der Verkauf nicht Produkte erster Wahl oder Produkte außerhalb der Produktion betrifft.

B.- PREISE

B.1. Vorbehaltlich abweichender schriftlicher Vereinbarungen gelten die von Mal zu Mal vereinbarten Verkaufspreise als Nettobarpreise bar mit Lieferung frei ab dem in der Auftragsbestätigung angegebenen Werk des Verkäufers.

C.- EIGENSCHAFTEN DER PRODUKTE

C.1. Der Käufer erklärt, die folgende auf der Web-Site des Unternehmen veröffentlichte Dokumentation zur Kenntnis genommen zu haben und sich an deren Inhalt zu halten: 1) Handbuch zur Verlegung, Benutzung, Reinigung und Pflege, und 2) Technische Datenblätter.

C.2. Aufgrund der intrinsischen Variabilität des Keramikprodukts sind die Eigenschaften der vorausgehend vom Verkäufer an den Käufer gesendeten Warenmuster und/oder Modelle hinweisend und unverbindlich.

C.3. Vorbehaltlich spezifischer Vereinbarungen vor der Auftragsbestätigung garantiert der Verkäufer nicht, dass die Lieferung des einzelnen Artikels vollständig mit dem gleichen Produktionslos ausgeführt wird.

D.- LIEFERFRISTEN

D.1. Die Lieferfristen sind unverbindlich und Verzögerungen führen für den Käufer in keinem Fall zum Anspruch auf Schadensvergütung.

D.2. Falls der Käufer das Material nicht innerhalb von 10 (zehn) Tagen ab dem Datum der Bereitstellung der Waren abholt, behält sich der Verkäufer das Recht vor, eine neue Lieferfrist festzusetzen.

E.- RÜCKLIEFERUNG UND VERSAND

E.1. Die eventuelle Änderung des Bestimmungsortes der Produkte, die sich von der in der Auftragsbestätigung vereinbarten unterscheidet, muss vom Käufer schriftlich innerhalb des zweiten Tags vor dem für die Abholung am Sitz des Verkäufers vorgesehenen mitgeteilt werden. Der Verkäufer behält sich das Recht vor, die Änderung der Bestimmung der Produkte nicht zu akzeptieren. Falls sich herausstellt, dass die effektive Bestimmung des Produkts von der vom Käufer angegebenen verschieden ist, behält sich der Verkäufer das Recht vor, die laufenden Lieferungen nicht auszuführen und/oder die laufenden Verträge aufzulösen, ohne dass der Käufer jeglichen Anspruch

auf Entschädigung geltend machen kann.

E.2. Vorbehaltlich abweichender Vereinbarungen erfolgt die Lieferung der Ware frei ab Werk (EXW gemäß den Incoterms 2010), und dies auch, falls vereinbart wird, dass der Versand oder ein Teil desselben im Auftrag des Käufers durch den Verkäufer erfolgt. In jedem Fall gehen die Risiken spätestens mit der Übergabe an das erste Transportunternehmen an den Käufer über.

E.3. Unter Beibehaltung der Nichtbeteiligung des Verkäufers am Transportvertrag kann der Verkäufer in der Police der Ladung als „Shipper“ angegeben werden. Die Mitteilung des Bruttogewichts des Containers an den Transportunternehmer stellt keine Übernahme der Verantwortung des Verkäufers hinsichtlich der SOLAS-Konvention dar (Safety Of Life At Sea). In keinem Fall kann diese Mitteilung als VGM (Verified Gross Mass) verstanden werden.

E.4. Der Käufer verpflichtet sich sicherzustellen, dass das zu den Lagern des Verkäufers gesendete Fahrzeug unter Berücksichtigung der Natur der Produkte für das Laden geeignet ist. Falls das zum Laden gesendete Fahrzeug größere Probleme beim Beladen bereitet, behält der Verkäufer sich das Recht vor, zur Abdeckung der höheren Logistikkosten eine Vertragsstrafe in Höhe von 4 % des Werts der Produkte zu erheben. Falls das Fahrzeug vollkommen ungeeignet ist, behält sich der Verkäufer das Recht vor, das Verladen zu verweigern, ohne dass der Käufer einen Anspruch auf Vergütung der Schäden geltend machen kann, die direkt und/oder indirekt daraus entstehen können.

E.5. Es ist Aufgabe des Käufers, das Transportunternehmen zu beauftragen und die Produkte vor dem Laden zu kontrollieren; eventuelle Anmerkungen zur Unversehrtheit der Verpackungen und der Übereinstimmung der geladenen Menge mit der in den Transportpapieren angegebenen müssen vom Transportunternehmen zum Zeitpunkt des Ladens vorgenommen werden. Diese Anmerkungen müssen auf alle Exemplaren der Transportpapiere vermerkt werden, anderenfalls gelten die geladenen Produkte als unbeschädigt und vollständig. Daraus folgt, dass der Verkäufer keinerlei Haftung für Fehlmengen oder Beschädigungen der Produkte übernimmt, die vom Transportunternehmen nicht gemeldet werden.

E.6. Es ist ebenfalls Aufgabe des Käufers, das Transportunternehmen zu beauftragen und die Modalität und die Stabilität des Ladens auf das Fahrzeug zu überprüfen, damit es während des Transports nicht zu Brüchen kommt, sowie die Einhaltung der Sicherheitsbestimmungen der Straßenverkehrsordnung zu gewährleisten.

F.- ZAHLUNGEN

F.1. Alle Zahlungsverpflichtung müssen am Firmensitz des Verkäufers erfüllt werden. Eventuelle Zahlungen an Handelsvertreter oder Außendienstmitarbeiter gelten als nicht geleistet, bis sie beim Verkäufer eingehen.

F.2. Es ist dem Käufer untersagt, die Zahlungen aus Ländern vorzunehmen, die vom Land seines Firmensitzes verschieden sind, falls diese Länder keinen angemessenen Informationsaustausch mit Italien gewährleisten. Im Fall der Verletzung dieses Verbots hat der Verkäufer das Recht, den Vertrag aus gutem Grund aufzulösen, ohne dass der Käufer eine Vergütung des entstandenen Schadens geltend machen kann.

F.3. Eventuelle Kosten und Gebühren für die Einziehung von Effekten und Wechseln gehen zu Lasten des Käufers. Im Fall der Nichteinhaltung des für die Zahlung festgesetzten Tags - auch nur partiell - fallen Säumniszinsen zu Gunsten des Verkäufers an, in der vom ital. Gesetzerlass vom 9. Oktober 2002, Nr. 231 vorgesehenen Höhe.

F.4. Vorbehaltlich abweichender schriftlicher Vereinbarungen verpflichtet sich der Käufer, keine Guthaben gegenüber dem Verkäufer zu verrechnen.

G.- BEANSTANDUNGEN

G.1. Beim Empfang der Produkte muss der Käufer sie einer sorgfältigen Sichtkontrolle gemäß den Angaben von Punkt 7 der Normen UNI EN ISO 10545-2 unterziehen.

G.2. Die Installation und die Verlegung der Produkte müssen unter Einhaltung der Empfehlungen zu den Arbeiten ausgeführt werden, die vor und während der Verlegung ausgeführt werden müssen, wie angegeben im Dokument 1) Handbuch zur Verlegung, Verwendung, Reinigung und Pflege, veröffentlicht auf der Web-Site des Verkäufers und angegeben auf der Verpackung des Produkts und/oder im Inneren derselben. Schäden, die durch eine falsche Installation, Verlegung und durch eine unterlassene/falsche Pflege (abweichend von den Angaben in 1) Handbuch zur Verlegung, Reinigung und Wartung), durch eine ungeeignete Gebrauchsbestimmung oder durch normale Abnutzung verursacht werden, werden nicht als Mängel des Produkts anerkannt.

G.3. Vorbehaltlich der Grenzen der Akzeptabilität, die von der internationalen Norm EN 14411 (ISO 13006) vorgesehen sind, erkennen die Parteien Mängel der Produkte als offensichtliche Mängel an, die bereits bei ihrem Empfang festgestellt werden können,

die das Material zur Verwendung ungeeignet machen oder die den Wert beträchtlich verringern. In diese Kategorie fallen Mängel, wie im Dokument definiert 1) Handbuch zur Verlegung, Benutzung, Reinigung und Pflege, veröffentlicht auf der Web-Site des Verkäufers. Als nicht erschöpfende Beispiele werden Oberflächenmängel, fehlerhafte Grafik, Defekte polierte Oberfläche, Defekte des Kalibers, der Planarität, der Rechtwinkligkeit/Gradlinigkeit, der Stärke, Risse, abgeschlagene Kanten, Fehlfarbe, gemischte Brandfarbe sowie Produkte mit Kantsplitterung durch Rettifizierung als offensichtliche Mängel anerkannt.

G.4. Falls der Käufer offensichtliche Mängel feststellt, muss er dies dem Verkäufer innerhalb von 8 (acht) Tagen ab dem Empfang schriftlich melden und die gesamte Charge des Materials für den Verkäufer zur Verfügung halten; anderenfalls verfällt der Rechtsanspruch. Bei der Beanstandung müssen die Daten der Rechnung sowie eine präzise Beschreibung des beanstandeten Mangels angegeben werden, falls möglich mit einer fotografischen Dokumentation. Falls die Beanstandung unberechtigt sein sollte, ist der Käufer gehalten, dem Verkäufer die für einen eventuellen Ortstermin aufgewendeten Kosten (Gutachten, Reisekosten, usw.) zu erstatten.

G.5. Versteckte Mängel müssen dem Verkäufer innerhalb von 8 (acht) Tagen ab Feststellung des Mangels per Einschreiben mit Rückschein gemeldet werden; anderenfalls verfällt der Rechtsanspruch.

G.6. Die Aktion des Käufers zur Inanspruchnahme der Mängelhaftung muss in jedem Fall innerhalb von 12 (zwölf) Monaten ab der Lieferung der Produkte erfolgen.

H.- MÄNGELHAFTUNG

H.1. Die Garantie des Verkäufers ist begrenzt auf Produkte erster Qualität und sie bezieht sich nicht auf Produkte zweiter oder dritter Qualität oder auf gelegentliche Partien mit besonderen Preisen oder Nachlässe, die in der Auftragsbestätigung angegeben werden.

H.2. Der Verkäufer garantiert nicht die Eignung der Produkte für besondere Verwendungen, sondern lediglich die technischen Eigenschaften, die auf der Web-Site in Dokument 2) Technische Datenblätter veröffentlicht sind. Die Angabe zur Verwendung ist als unverbindlich anzusehen, auch wenn vom Verkäufer in Katalogen und Handbüchern angegeben ist. Es ist stets Aufgabe des Planers, auf der Grundlage der in den 2) Technischen Datenblättern angegebenen Eigenschaften die Eignung des Produkts für spezifische Nutzungsbedingungen zu bewerten, unter Berücksichtigung der Belastungen sowie der Variablen, die am Ort der Bestimmung auftreten und die Eigenschaften verändern können, wie zum Beispiel die Intensität des Verkehrs, die Qualität des Verkehrs (Begehung bei Vorhandensein von Sand, Schmutz usw.), die eventuellen klimatischen Bedingungen sowie alle sonstigen Einflüsse, denen das Material ausgesetzt sein kann.

H.3. Falls festgestellt wird, dass das Produkt offensichtliche Mängel aufweist, wie definiert in Punkt G, Nr. 3, nimmt der Verkäufer die Ersetzung des mangelhaften Produkts durch ein anderes mit gleichen oder höherwertigen Eigenschaften vor, oder er nimmt eine angemessene Reduzierung des Preises vor, falls dies nicht möglich ist. Alternativ hat der Käufer nach Rücklieferung der mangelhaften Produkte das Recht auf Rückerstattung des bezahlten Preises, zuzüglich der Transportkosten, mit Ausschließung der Vergütung aller direkten und/oder indirekten Schäden.

H.4. Die Garantie des Verkäufer wird ausgeschlossen, falls das mangelhafte Produkt (ganz oder teilweise) verwendet und/oder umgewandelt worden ist, da davon ausgegangen wird, dass der Käufer (oder sein Kunde) dadurch seinen Willen zum Ausdruck gebracht hat, es in dem Zustand zu akzeptieren, in dem es sich befindet.

H.5 Falls festgestellt wird, dass das Produkt versteckte Mängel aufweist, ist die Garantie des Verkäufers auf die Ersetzung des Materials durch anderes mit gleichen oder höherwertigen Eigenschaften beschränkt oder - falls dies nicht möglich ist - auf die Rückerstattung des bezahlten Preises, zuzüglich der Transportkosten. In jedem Fall ist die Garantie des Verkäufers für alle direkten und/oder indirekten Schäden, die durch das mangelhafte Produkt entstehen, auf einen Betrag begrenzt, der das Doppelte des Verkaufspreises nicht übersteigen kann, den der Verkäufer auf den mangelhaften Teil der Lieferung angewendet hat.

H.6. Falls der Käufer das Produkt an Kunden weiterverkauft, die vom Verbraucherschutzgesetz (ital. Gesetzerlass Nr. 206/2005) geschützt werden, ist er verantwortlich für die angewendeten Bedingungen, falls diese von den hier angegebenen abweichen, und er muss sicherstellen, dass die Rechte des Verbrauchers gemäß den Bestimmungen dieses Gesetzes ausgeübt werden können. Falls die Voraussetzungen gegeben sind, kann das Regressrecht des Käufers gegenüber dem Verkäufer/Hersteller nicht die Grenzen übersteigen, die von Punkt G, Nr. 1 bis Punkt H,

Nr. 5 angegeben werden.

I. KLAUSEL SOLVE ET REPETE UND AUFLÖSUNGSKLAUSEL

I.1. Gemäß den Bestimmungen von § 1462 des ital. Bürgerlichen Gesetzbuches kann der Käufer in keinem Fall - einschließlich von vermeintlichen Mängeln oder Defekten des Materials - die Zahlung des abgenommenen Materials aussetzen oder verzögern, natürlich vorbehaltlich des Rechts, ungerechtfertigt gezahlte Beträge zurückzufordern, und dies nur nach Erbringung des Nachweises der Rechtmäßigkeit der Forderung (Solve et Repete).

I.2. Im Fall der Veränderung der Vermögensbedingungen des Käufers oder der auch nur partiellen Nichtbezahlung der bereits gelieferten Produkte kann der Verkäufer die laufenden Lieferungen aussetzen und/oder die laufenden Verträge auflösen, ohne dass der Käufer die Vergütung von direkten und/oder indirekten Schäden geltend machen kann.

L.- EIGENTUMSVORBEHALT

L.1. Bis zur vollständigen Bezahlung des Preises durch den Käufer bleiben die Produkte, die den Gegenstand der Lieferung darstellen, Eigentum des Verkäufers.

L.2. Während dieses Zeitraums übernimmt der Käufer die Pflichten und die Verantwortlichkeiten für die Aufbewahrung der gekauften Produkte und er kann sie nicht veräußern, zur Nutzung überlassen oder beschlagnahmen oder pfänden lassen, ohne das Eigentum des Verkäufers anzugeben und ohne diesen umgehend per Einschreiben mit Rückschein zu benachrichtigen.

M.- HÖHERE GEWALT

M.1. Beide Parteien können die Ausführung der vertraglichen Pflichten aussetzen, wenn die Ausführung aus Gründen, die vom eigenen Willen unabhängig sind, unmöglich oder objektiv zu aufwendig wird, wie zum Beispiel: Streiks, Boykott, Aussperrung, Brand, Krieg (erklärt oder nicht), Bürgerkrieg, Aufstände und Revolutionen, Beschlagnahme, Embargo, Unterbrechungen der Energieversorgung, außerordentliche Defekte von Maschinen, Verspätung bei der Anlieferung von Komponenten und Rohstoffen.

M.2. Die Partei, die beabsichtigt, die vorliegende Klausel in Anspruch zu nehmen, muss der anderen Partei schriftlich das Auftreten von Umständen der Höheren Gewalt mitteilen.

M.3. Falls die Aussetzung aufgrund von Höherer Gewalt mehr als 60 (sechzig) Tage andauert, haben beiden Parteien das Recht, den vorliegenden Vertrag nach einer schriftlichen Vorankündigung von 10 (zehn) Tagen an die Gegenpartei aufzulösen.

N.- VERTRAULICHKEITSPFLICHT

N.1. Der Käufer ist gehalten, über alle technischen Informationen (wie zum Beispiel Zeichnungen, Prospekte, Dokumentationen, Formeln und Schriftverkehr) und kommerziellen Informationen (einschließlich der Vertragsbedingungen, der Kaufpreise, der Zahlungsbedingungen usw.), in deren Kenntnis während der Ausführung des vorliegenden Vertrages kommt, absolute Vertraulichkeit einzuhalten.

N.2. Die Vertraulichkeitspflicht wird für die Dauer des Vertrages sowie den Zeitraum nach seiner Ausführung übernommen.

N.3. Im Fall der Nichteinhaltung der Vertraulichkeitspflicht ist die nicht einhaltende Partei gehalten, der anderen Partei alle daraus entstehenden Schäden zu vergüten.

O.- MARKEN UND KENNZEICHNUNGEN DES VERKÄUFERS

O.1. Die Verwendung von Marken, Ziermotiven und geistigem Eigentum im Allgemeinen in jeder Form sowie jeder Ausdrucksform (als nicht erschöpfendes Beispiel: Bilder, Fotos, Zeichnungen, Filme, Abbildungen, Strukturen usw.), die intellektuelles Eigentum des Verkäufers sind, ist auf jede Weise (als nicht erschöpfendes Beispiel: Presse, Video, Radio, Internet, Social Media, Instant-Message-Plattform oder VoIP usw.) strengstens untersagt. Alle - auch nur partielle - Abweichungen von diesem Verbot müssen von Fall zu Fall schriftlich von der Generaldirektion des Verkäufers autorisiert werden.

P.- SPRACHE DES VERTRAGS, ANWENDBARES RECHT, RECHTSPRECHUNG UND GERICHTSSTAND

P.1. Der Vertrag und die vorliegenden Bedingungen werden in italienischer Sprache verfasst, die im Fall der Abweichung der Übersetzung in andere Sprachen Vorrang hat.

P.2. Die Regelung aller Rechtssachen hinsichtlich den Lieferungen unterliegt der Rechtsprechung des italienischen Staats und die territoriale Zuständigkeit liegt ausschließlich beim Bezirksgericht Modena, dem Ort des Firmensitzes des Verkäufers.

Weitere Informationen entnehmen Sie bitte den Allgemeinen Geschäftsbedingungen, die unter der Adresse www.atlasconcorde.com zur Verfügung stehen.

Condiciones generales de venta

A.- MODALIDADES DE CELEBRACIÓN DEL CONTRATO

A.1. Las presentes Condiciones Generales de Venta disciplinan todo contrato de venta entre el Vendedor y el Comprador y toda modificación o cancelación debe ser establecida por escrito.

A.2. Eventuales ofertas, acreditaciones y/o descuentos otorgados por agentes u otros intermediarios, no son considerados válidos mientras no sean confirmados por escrito por el Vendedor.

A.3. El Comprador envía al Vendedor, directamente o a través de agentes, pedidos por escrito que deben contener la indicación de los códigos de los productos requeridos, de las cantidades, de sus precios y de su destino. El pedido enviado por el Comprador es irrevocable.

A.4. La venta deberá considerarse perfeccionada desde el momento en que: (a) el Comprador recibe por parte del Vendedor una confirmación -escrita a través de e-mail, fax u otros medios telemáticos- conforme con los términos y según las condiciones del pedido; o (b) en caso de confirmación enviada por el Vendedor que contenga condiciones diferentes de las del pedido enviado por el Comprador cuando este las acepte por escrito o, en todo caso, no las cuestione dentro de los 7 (siete) días sucesivos a la recepción; o (c) en ausencia de confirmación escrita por el Vendedor, en el momento en que los productos serán entregados y serán cargados por el Comprador.

A.5. El Comprador comprende y acepta la necesidad de limitar al territorio nacional las ventas de los productos Atlas Concorde. El Vendedor estima que esta norma constituye un factor indispensable para poder coordinar su política comercial y racionalizar la red de distribución, con ofertas más orientadas a los requerimientos de cada país. De igual modo, el Comprador reconoce que este requerimiento constituye también salvaguardia de sus propios intereses. Por lo tanto, el Comprador se obliga a comercializar los productos suministrados por Ceramiche Atlas Concorde SpA exclusivamente en su país de residencia, absteniéndose de promover ventas activas, solicitadas incluso online, respecto a clientes domiciliados en el territorio de cualquier otro país que no sea el propio. Para operaciones triangulares esta obligación se aplica al país de operatividad efectiva del Comprador. El Comprador podrá revender el producto fuera de su propio territorio en caso de recibir autorización por escrito por parte del Vendedor o en caso de que la reventa se refiera a productos que no sean de primera selección o que estén fuera de producción.

B.- PRECIOS

B.1. Salvo acuerdo escrito en contrario, los precios de venta acordados de manera puntual se entienden al neto en efectivo y para entrega en el establecimiento del Vendedor indicado en la confirmación del pedido.

C.- CARACTERÍSTICAS DE LOS PRODUCTOS

C.1. El Comprador declara haber visto y atenerse al contenido de la siguiente documentación publicada en el sitio internet de la empresa: 1) Manual de Colocación, Uso, Limpieza y Mantenimiento y 2) Fichas Técnicas.

C.2. Dada la intrínseca variabilidad del producto cerámico, las características de las muestras y/o modelos enviados anteriormente por el Vendedor al Comprador deben ser considerados como aproximados y no vinculantes.

C.3. Salvo especificaciones requeridas, a acordar antes de la confirmación del pedido, el Vendedor no garantiza que el pedido de un artículo en particular sea despachado como un mismo lote de producción.

D.- PLAZOS DE ENTREGA

D.1. Los plazos de entrega deben entenderse como aproximados y su prórroga no puede devengar a favor del Comprador ningún derecho a solicitar indemnizaciones, sin excepciones posibles.

D.2. Si, una vez transcurridos 10 (diez) días desde la fecha de aviso de estar lista la mercancía, el Comprador no retira el material, el Vendedor se reserva de establecer discrecionalmente un nuevo plazo de entrega.

E.- ENTREGA Y TRANSPORTE

E.1. La eventual variación de lugar de destino de los productos, señalando uno diferente respecto de aquel acordado en la confirmación de pedido, debe ser comunicada por el Comprador por escrito dentro del plazo máximo taxativo del penúltimo día previo al retiro desde el establecimiento del Vendedor. El Vendedor se reserva la facultad de no aceptar el cambio de lugar de destino de los Productos. En caso de verificarse que el destino efectivo del producto sea diferente de aquel declarado por el Comprador, el Vendedor se reserva la facultad de suspender la realización de los suministros en curso y/o de rescindir

los contratos en curso sin que el Comprador pueda pedir resarcimientos directos y /o indirectos de ningún tipo.

E.2. Salvo acuerdo en contrario, el suministro de la mercancía se entiende ex Works (EXW según Incoterms 2010) y ello también cuando se acuerde que el transporte o parte de él quede a cargo del Vendedor, según mandato del Comprador. En todo caso, los riesgos se transfieren al Comprador a más tardar con la entrega al primer transportador.

E.3. Como confirmación del hecho de que el Vendedor es ajeno al contrato de transporte, el mismo no podrá ser indicado como “shipper” en la póliza de carga. La comunicación del peso bruto del contenedor al transportista no comporta ninguna asunción de responsabilidad de parte del Vendedor para los fines del Convenio SOLAS (Safety Of Life At Sea). De ninguna manera la antedicha comunicación podrá ser considerada como VGM (Verified Gross Mass).

E.4. El Comprador se compromete a fin de que el vehículo enviado al establecimiento del Vendedor sea idóneo para cargar considerando la naturaleza de los productos. En caso de que el vehículo que se presenta comporte significativas dificultades para las operaciones de carga, el Vendedor se reserva el derecho a incluir una recarga del 4 % del valor de los productos a cobertura de los mayores costos logísticos. Si el vehículo enviado para retirar la mercancía no es absolutamente idóneo, el Vendedor se reserva la facultad de negar las operaciones de carga sin que nada pueda requerir el Comprador a título de resarcimiento por todo eventual costo directo y/o indirecto que de ello pueda derivar.

E.5. Es tarea del Comprador encargar al transportista controlar los productos antes de cargarlos; eventuales observaciones sobre la integridad de los embalajes y la exactitud de las cantidades cargadas, así como aquellas puestas en el documento de transporte, deben ser presentadas por el transportista en el momento de cargar. Estas observaciones deben ser reproducidas en todas las copias de los documentos de transporte; de lo contrario los productos cargados se entienden íntegros y completos. De ello deriva que el Vendedor no se asume ninguna responsabilidad con referencia a faltas o daños en los productos no señalados por el transportista.

E.6. Asimismo, es responsabilidad del Comprador encargar al transportista verificar las modalidades y la estabilidad de la carga sobre el vehículo a fin de que durante el transporte no se produzcan roturas y que sean respetadas todas las disposiciones sobre seguridad relativas a la circulación por vías públicas.

F.- PAGOS

F.1. Toda obligación de pago debe ser cumplida en la sede legal del Vendedor. Eventuales pagos a agentes, representantes o auxiliares de comercio no se entienden efectuadas mientras las respectivas sumas no lleguen a poder del Vendedor.

F.2. Queda prohibido para el Comprador cumplir su propia obligación mediante pagos provenientes de países que no sean su propio país de residencia si se trata de países que no garantizan adecuado intercambio de informaciones con Italia. En caso de violación de esta prohibición, el Vendedor tiene facultad de rescindir el contrato por justa causa sin que el Comprador pueda pretender derecho de obtener algún resarcimiento por eventual daño sufrido.

F.3. Eventuales gastos de sello fiscal y de cobro de letras de cambio y efectos comerciales quedan a cargo del Comprador. En caso de incumplimiento, incluso solo parcial, del día fijado para el pago, se devengarán a favor del Vendedor los intereses de mora en la medida prevista por el Decreto Leg. n° 231 del 09/10/2002.

F.4. Salvo acuerdos escritos que lo contradigan, el Comprador se compromete a no compensar ningún crédito de cualquier forma creado respecto del Vendedor.

G.- RECLAMOS

G.1. Al recibir los productos, el Comprador deberá someterlos a cuidadoso control a través de un examen visual efectuado conforme según las indicaciones del punto 7.4 de las normas UNI EN ISO 10545-2.

G.2. La instalación y colocación de los productos deberá efectuarse respetando escrupulosamente las recomendaciones inherentes a las actividades a realizar antes y durante la colocación, indicadas en el documento 1) Manual de Colocación, Uso, Limpieza y Mantenimiento publicado en el sitio internet del Vendedor y en el embalaje del producto y/o en el interior del mismo. No son considerados como vicios del producto aquellos generados por una errónea instalación y error/falta de mantenimiento (intervenciones diferentes de las instrucciones proporcionadas en el 1) Manual de Colocación, Uso, Limpieza y Mantenimiento), por un uso inapropiado y/o por el normal desgaste con el pasar del tiempo.

G.3. Sin perjuicio de los límites de aceptabilidad previstos por la norma internacional

EN 14411 (ISO 13006), las partes reconocen como vicios evidentes los defectos de los productos constatables ya en el momento de su recepción y tales que impidan el uso previsto del material o reduzcan de modo apreciable su valor. Forman parte de esta categoría los defectos precisamente establecidos en el documento 1) Manual de Colocación, Limpieza y Mantenimiento publicado en el sitio internet del Vendedor. A título solo de ejemplo, se reconocen como vicios evidentes los defectos superficiales, los defectos de decoración, de lepeado/pulido, de calibre, de planitud, de ortogonalidad-rectilineidad, de espesor, las grietas, los astillados, las variaciones de tono, los tonos mezclados y los productos que presentan problemas de cortes/escamas.

G.4. En caso de que el Comprador observe la presencia de vicios evidentes, deberá presentar reclamo al Vendedor por escrito, so pena de extinción del derecho, dentro de los 8 (ocho) días sucesivos a la recepción y mantener a disposición del Vendedor la partida completa de material. El reclamo deberá indicar los datos de facturación y una precisa descripción del vicio observado incluyendo, en lo posible, imágenes fotográficas. En caso de que el reclamo debiera demostrarse luego ser infundado, el Comprador se declara dispuesto a resarcir al Vendedor por los gastos efectuados para realizar la respectiva constatación in situ (peritajes, viajes, etc.).

G.5. Los vicios ocultos deberán ser notificados al Vendedor mediante carta certificada con aviso de recibo, bajo pena de caducidad de la garantía, dentro de los 8 (ocho) días a contar de la fecha del descubrimiento del defecto.

G.6. La acción del Comprador tendiente a hacer valer la garantía por vicios prescribe, en todo caso, en el plazo de 12 (doce) meses a contar de la entrega de los productos.

H.- GARANTÍA POR VICIOS

H.1. La garantía del Vendedor se entiende limitada solo a los productos de primera selección y no a los productos de segunda o tercera selección o de partidas de ocasión con precios o descuentos especiales cuando ello se encuentra debidamente señalados en nota en la confirmación del pedido.

H.2. El Vendedor no garantiza la idoneidad de los productos para usos particulares, sino solo las características técnicas publicadas en el sitio internet, documento 2) Fichas Técnicas. La indicación de uso, incluso cuando es presentada por el Vendedor en catálogos y manuales, debe considerarse solo como genérica. Sobre la base de las características técnicas señaladas en las 2) Fichas Técnicas, es siempre tarea del proyectista evaluar la idoneidad del producto en función de las condiciones específicas de uso en consideración de las solicitudes y de las variables que pueden operar en el ambiente de destino, alterando sus características; a título de ejemplo: la intensidad del tráfico, la calidad del tráfico (tránsito en presencia de arena, de detritos, etc.), las eventuales condiciones climáticas adversas y cualquier otro factor aleatorio al que puede quedar expuesto el material.

H.3. En caso de comprobarse que el producto manifieste vicios evidentes, tal como han sido definidos en la letra G n°. 3, el Vendedor procederá a sustituir el producto defectuoso con otro con características iguales o superiores o, en el caso de que ello no sea posible, deberá efectuar una congrua reducción del precio. Como alternativa, el Comprador tendrá derecho, previa devolución de los productos viciados, al reembolso del precio pagado, agregándose el costo del transporte, con exclusión del resarcimiento de todo otro daño, directo y/o indirecto.

H.4. La garantía del Vendedor debe considerarse excluida en caso de que el producto que presenta vicios evidentes (total o parcialmente) haya sido utilizado y/o, en cualquier caso, transformado, debiéndose estimar que de tal modo el Comprador (o su cliente) ha expresado la voluntad de aceptarlo en el estado en que se encuentra.

H.5. En los casos en que quede comprobado que el producto presenta vicios ocultos, la garantía del Vendedor queda limitada a la sustitución del material con otro de características iguales o superiores y, allí donde ello no sea posible, al reembolso del precio pagado, agregándose el costo del transporte. En todo caso, la garantía del Vendedor por cada daño directo y/o indirecto de cualquier forma derivado de producto defectuoso, debe entenderse limitada a una suma que no podrá superar el doble del precio de venta aplicado por el Vendedor, con referencia solo a la parte defectuosa del suministro.

H.6. En caso de que el Comprador revenda el producto a terceros protegidos por el código del consumo (D.L. n°. 206/2005), será responsable de las condiciones practicadas si son diferentes de aquellas aquí señaladas y deberá comprobarse que los derechos del consumidor sean ejercidos con aplicación de los remedios y de los términos fijados por el antedicho código. En caso de subsistir las condiciones, el derecho de devolución y/o, en todo caso, de compensación a favor del Comprador respecto del

Vendedor/productor, no podrán excederse las exenciones ni límites establecido en la letra G del n°. 1 y en la letra H n°. 5.

I. CLÁUSULAS SOLVE ET REPETE Y RESOLUTIVAS

I.1. De conformidad con lo dispuesto por el art. 1462 del Código Civil, por ningún motivo, incluidos supuestos vicios o defectos del material, el Comprador podrá suspender o retardar el pago del material retirado, sin perjuicio obviamente de la facultad de restitución cuando pueda demostrar que ha pagado indebidamente.

I.2. En el caso de cambiar las condiciones patrimoniales del Comprador o de falta de pago incluso parcial de productos ya suministrados, el Vendedor podrá suspender la realización de los suministros en curso y/o rescindir los contratos en curso sin que el Comprador pueda reivindicar resarcimientos directos ni indirectos de cualquier clase.

L.- PACTO DE RESERVADO DOMINIO

L.1. Mientras el Comprador no haya efectuado el pago integral del precio, los productos objeto del suministro seguirán siendo de propiedad del Vendedor.

L.2. Durante el período antedicho, el Comprador asumirá las obligaciones y las responsabilidades del depositario y no podrá enajenar, entregar en uso ni dejar retener o embargar los productos sin declarar la propiedad del Vendedor y enviar inmediatamente aviso con carta certificada con aviso de recibo.

M.- FUERZA MAYOR

M.1. Cada parte podrá suspender la ejecución de sus obligaciones contractuales cuando esa ejecución se haga imposible u objetivamente demasiado onerosa por impedimento imprevisible independiente de su voluntad, tal como por ejemplo: huelga, boicot, bloqueo, incendio, guerra (declarada o no declarada), guerra civil, rebelión y revolución, requisición, embargo, interrupción de energía, rotura extraordinaria de maquinaria, retraso en la entrega de componentes o materias primas.

M.2. La parte que desee valerse de la presente cláusula deberá comunicar de inmediato por escrito a la otra parte el verificarse y el cese de las circunstancias de fuerza mayor.

M.3. En caso de que la suspensión causada por fuerza mayor dure más de 60 (sesenta) días, cada una de las partes tendrá derechos de rescindir el presente contrato, con preaviso de 10 (diez) días, a comunicar a la otra parte por escrito.

N.- OBLIGACIÓN DE CONFIDENCIALIDAD

N.1. El Comprador debe mantener la más absoluta confidencialidad respecto de todas las informaciones de carácter técnico (tales como, solo como ejemplo, diseños, prospectos, documentaciones, fórmulas y correspondencia) y de carácter comercial (incluidas las condiciones contractuales, los precios de compra, las condiciones de pago, etc.) obtenidas a propósito de la ejecución del presente contrato.

N.2. La obligación de confidencialidad es válida por toda la duración del contrato, así como por el período sucesivo a su ejecución.

N.3. En cualquier caso de inobservancia de la obligación de confidencialidad, la parte incumplidora deberá indemnizar a la otra por todos los daños que de ello puedan derivar.

O.- MARCAS Y SIGNOS DISTINTIVOS DEL VENDEDOR

O.1. Queda severamente prohibido el uso a través de cualquier medio (tales como, solo a título de ejemplos no exhaustivos: prensa, videos, radio, internet, social media, plataformas de mensajería instantánea o VoIP, etc.) de las marcas, de los modelos ornamentales y de las obras del ingenio en general que constituyan propiedad intelectual del Vendedor y ello en cualquier forma o modo de expresión (tales como, solo a título de ejemplos no exhaustivos: imágenes, fotos, dibujos, videos, figuras, estructuras, etc.). Cualquier excepción a esta prohibición, incluso solo parcial, deberá ser autorizada caso por caso por escrito por la dirección general del Vendedor.

P.- IDIOMA DEL CONTRATO, LEY APLICABLE, JURISDICCIÓN Y COMPETENCIA

P.1. El contrato y las presentes condiciones son redactados en lengua italiana, la cual prevalecerá en caso de divergencia con las traducciones en otros idiomas.

P.2. La resolución de cualquier controversia de cualquier forma relativa al suministro queda sujeta a la ley y a la jurisdicción del Estado Italiano y la competencia territorial es asignada de forma exclusiva al Tribunal de Módena, en cuya circunscripción el Vendedor tiene su domicilio legal.

Para mayor información, consultar las Condiciones Generales de Venta, disponible en la dirección www.atlasconcorde.com

Общие условия продажи

A.- ПОРЯДОК ЗАКЛЮЧЕНИЯ ДОГОВОРА

A.1. Настоящие Общие условия продажи регулируют любой договор продажи, заключенный между Продавцом и Покупателем; любое изменение или отступление от них должно быть согласовано в письменной форме.

A.2. Возможные коммерческие предложения, зачисления и/или бонусы, предоставленные агентами или другими посредниками, не имеют силы, если они не были подтверждены в письменной форме Продавцом.

A.3. Покупатель направляет Продавцу непосредственно или через агентов письменные заказы, в которых должны быть указаны коды запрошенной продукции, количества, цены и место назначения. Отправленный Покупателем заказ отмене не подлежит.

A.4. Продажа считается завершенной в тот момент, когда: (i) Покупатель получает от Продавца по электронной почте, факсу или другим телематическим средствам связи письменное подтверждение, соответствующее срокам и условиям заказа; или (ii) в случае, если в отправленном Продавцом подтверждении указаны условия, отличающиеся от условий в заказе Покупателя, если Покупатель письменно принимает это подтверждение или не возражает на него в течение 7 (семи) дней после его получения; или (iii) при отсутствии письменного подтверждения Продавца, в тот момент, когда Продукция передается Покупателю и загружается им.

A.5. Покупатель соглашается с необходимостью ограничить территорию продажи продукции Atlas Concorde государственными границами. Продавец считает это правило необходимым элементом, который позволит ему координировать свою коммерческую политику и оптимизировать дистрибутивную сеть посредством предложений, которые будут больше соответствовать потребностям отдельных стран. Аналогично этому, Покупатель соглашается, что эта необходимость представляет собой защиту также и его интересов. Таким образом, Покупатель обязуется реализовывать продукцию, поставленную компанией Ceramiche Atlas Concorde SpA, лишь только в его стране, воздерживаясь от продвижения активной продажи, также онлайновой, клиентам, находящимся на территории другой страны. В операциях триангуляции данное обязательство распространяется на страну, в которой ведется реальная оперативная деятельность Покупателя. Покупатель сможет перепродать продукцию за пределами своей территории в том случае, если он получит письменное разрешение Продавца, или же в случае перепродажи продукции не первого сорта или снятой с производства.

B.- ЦЕНЫ

B.1. При отсутствии иных письменных договоренностей согласованные в каждом отдельном случае отпускные цены подразумеваются как цены нетто, за наличный расчет и на условиях поставки франко завод Продавца, указанный в подтверждении заказа.

C.- ХАРАКТЕРИСТИКИ ПРОДУКЦИИ

C.1. Покупатель заявляет, что он ознакомился и придерживается содержания следующей документации, размещенной на корпоративном сайте в интернете: 1) Руководство по укладке, использованию, чистке и уходу и 2) Технические данные.

C.2. Учитывая свойственное непостоянство керамической продукции, характеристики образцов и/ моделей, ранее отправленных Продавцом Покупателю, должны считаться ориентировочными и не обязывающими.

C.3. При отсутствии специальных требований, которые должны быть оговорены до подтверждения заказа, Продавец не гарантирует, что заказ на отдельное изделие будет полностью состоять из одной и той же производственной партии.

D.- СРОКИ ПОСТАВКИ

D.1. Сроки поставки должны считаться ориентировочными, а их отсрочка не дает Покупателю ни при каких обстоятельствах право требовать компенсацию.

D.2. Если Покупатель не заберет материал по истечении 10 (десяти) дней с момента уведомления о готовности товара, Продавец может по собственному усмотрению назначить новый срок поставки.

E.- ДОСТАВКА И ОТГРУЗКА

E.1. О возможном изменении места назначения Продукции, если оно отличается от места, согласованного в подтверждении заказа, необходимо сообщить Продавцу в письменной форме не позднее, чем за два дня до даты, предусмотренной для вывоза товара с завода Продавца. Продавец оставляет за собой право не принимать изменение места назначения Продукции. Если устанавливается, что фактическое место назначения Продукции отличалось от заявленного Покупателем, то Продавец оставляет за собой право на приостановку исполнения текущих поставок и/или на расторжение текущих договоров без права Покупателя на требование прямого или косвенного возмещения какого-либо типа.

E.2. При отсутствии иных договоренностей поставка товара подразумевается на условиях франко-завод (EXW в соответствии с правилами Incoterms 2010), даже если было согласовано, что отгрузка или ее часть должна осуществляться Продавцом по поручению Покупателя. В любом случае риск переходит к Покупателю не позднее чем при передаче товара первому грузоперевозчику.

E.3. Исходя из того, что Продавец не является стороной договора перевозки, в коносаменте не допускается указание Продавца как "грузоотправителя". Сообщение Продавцом грузоперевозчику веса брутто контейнера не является принятием на себя ответственности в соответствии с конвенцией СОЛАС (Safety Of Life At Sea). Это сообщение не может ни в коем случае толковаться как проверка массы грузженных контейнеров VGM (Verified Gross Mass).

E.4. Покупатель обязуется направить на склад Продавца транспортное средство, пригодное для погрузки Продукции данного типа. Если прибывшее транспортное средство значительно затрудняет выполнение погрузочных операций, то Продавец оставляет за собой право наложить пеню в размере 4% от стоимости продукции за возмещение более высоких логистических расходов. Если согласованное транспортное средство является совершенно неподходящим, Продавец оставляет за собой право отказать в выполнении погрузочных операций, при этом Покупатель не может требовать возмещения вытекающего из этого любого прямого и/или косвенного убытка.

E.5. Покупатель обязан поручить грузоперевозчику проверку продукции перед ее погрузкой. Возможные замечания о целостности упаковки и о соответствии загруженных количеств тем, которые указаны в транспортной накладной, должны быть сделаны грузоперевозчиком в момент погрузки. Эти замечания необходимо указать во всех копиях транспортных накладных, в противном случае погруженная продукция считается неповрежденной и комплектной. Из этого следует, что Продавец не несет никакой ответственности за недостачи или повреждения продукции, не отмеченные грузоперевозчиком.

E.6. Кроме того, Покупатель также обязан поручить грузоперевозчику проверку порядка погрузки и стабильности груза в транспортном средстве, чтобы во время перевозки не возникли повреждения, и чтобы были соблюдены все правила безопасности дорожного движения.

F.- ОПЛАТА

F.1. Любые платежные обязательства должны выполняться по юридическому адресу Продавца.Оплата агентам, представителям или торговым помощникам считается несовершенной до тех пор, пока соответствующие суммы не поступят Продавцу.

F.2. Покупателю запрещается выполнять свои обязательства путем оплаты из стран, не являющихся страной, резидентом которой он является, если эти страны не гарантируют адекватный обмен информацией с Италией. В случае нарушения этого запрета Продавец имеет право на расторжение договора с надлежащим правовым основанием, а у Покупателя не возникнет право на получение какого-либо возмещения за понесенный ущерб.

F.3. Пошлины и расходы на инкассирование векселей и тратт несет Покупатель. В случае даже частичной задержки платежа по сравнению с назначенным днем оплаты в пользу Продавца будут начисляться проценты в размере, предусмотренном законодательным декретом от 09/10/2002 № 231.

F.4. При отсутствии иных письменных договоренностей Покупатель обязуется не компенсировать никакой кредит по отношению к Продавцу, вне зависимости от причин его возникновения.

G.- ПРЕТЕНЗИИ

G.1. При получении Продукции Покупатель должен внимательно осмотреть ее в соответствии с указаниями п. 7 стандарта UNI EN ISO 10545-2.

G.2. При установке и укладке Продукции необходимо внимательно придерживаться рекомендаций по работам, выполняемым до и во время укладки, приведенных в документе 1) Руководство по укладке, использованию, чистке и уходу, размещенном на сайте Продавца в интернете, а также рекомендаций, указанных на упаковке изделия и/или приведенных внутри упаковок. Не считаются дефектами Продукции дефекты, возникшие в результате неправильной установки, отсутствия / неправильного ухода (не в соответствии с указаниями, приведенными в 1) Руководстве по укладке, использованию, чистке и уходу), по причине неподходящей сферы применения и/или обычного износа с течением времени.

G.3. Соблюдая пределы приемлемости, предусмотренные международным стандартом EN 14411 (ISO 13006), стороны признают как явные дефекты те дефекты Продукции, которые были заметными уже при ее получении, и которые делают материал неподходящим для

применения или существенно снижают его ценность. В эту категорию входят дефекты в соответствии с определением, приведенным в документе 1) Руководство по укладке, использованию, чистке и уходу, размещенном на сайте Продавца в интернете. В качестве неисчерпывающего перечня признаются как явные дефекты следующие: дефекты поверхности, декора, шлифовки/полировки, калибра, плоскостности, ортогональности-прямолинейности, толщины, трещины, сколы, несоответствие тона, смешение тона, а также изделия с дефектами резки и сколами.

G.4. Если Покупатель обнаруживает явные дефекты, то он должен предъявить претензию Продавцу в письменном виде в течение 8 (восьми) дней с момента получения Продукции, в противном случае он теряет право на претензию, кроме того, Покупатель должен оставить всю партию материала в распоряжении Продавца. В претензии необходимо указать данные инвойса и точное описание дефекта, сопровождаая его, если это возможно, фотографиями. Если претензия окажется необоснованной, то Покупатель должен быть готовым возместить Продавцу расходы, понесенные им в связи с осмотром на месте (экспертизы, проезд и тд.).

G.5. О скрытых дефектах необходимо сообщать Продавцу заказным письмом с уведомлением о вручении в течение не более 8 (восьми) дней с момента обнаружения дефекта, в противном случае гарантия теряет силу.

G.6. В любом случае, предоставленная Покупателю гарантия на дефекты теряет силу по истечении 12 (двенадцати) месяцев с момента получения Продукции.

H.- ГАРАНТИЯ НА ДЕФЕКТЫ

H.1. Гарантия Продавца распространяется только на Продукцию первого сорта, и не распространяется на Продукцию второго, третьего сорта, а также на партии со спецпредложениями, по которым были предложены специальные скидки или цены, отмеченные в примечаниях в подтверждении заказа.

H.2. Продавец не гарантирует пригодность Продукции для специальных видов применения, а лишь только ее технические характеристики, размещенные на сайте в интернете, в документе 2) Технические данные. Сфера применения, даже если она указана Продавцом в каталогах и руководствах, должна считаться лишь только ориентировочной. На основании технических характеристик, приведенных в 2) Технические данных, проектировщик обязан оценить пригодность Продукции к конкретным условиям применения, в зависимости от нагрузок и от переменных факторов, которые могут возникнуть в среде применения, изменяя характеристики Продукции, такие как: интенсивность хождения, качество хождения (наличие песка, мусора и тд.), возможные неблагоприятные климатические условия и любые другие случайные факторы, которые могут оказать воздействие на материал.

H.3. В случае установления того факта, что Продукция имеет явные дефекты в соответствии с положениями п. 3 раздела G, Продавец заменит дефектную Продукцию другой, обладающей такими же или более высокими характеристиками. Если это невозможно, то он надлежащим образом снизит цену. В качестве альтернативы после возврата дефектной Продукции Покупатель имеет право на возмещение уплаченной цены и транспортных расходов, при этом исключено возмещение любого другого прямого и/или косвенного ущерба.

H.4. Гарантия Продавца считается отмененной в случае, если Продукция, частично или полностью имеющая явные дефекты, была использована и/или трансформирована каким-либо образом, поскольку считается, что этими действиями Покупатель (или его клиент) выразил волю принять Продукцию в том состоянии, в котором она находится.

H.5. В случае установления того факта, что Продукция имеет скрытые дефекты, гарантия Продавца ограничена заменой материала другим, обладающим такими же или более высокими характеристиками. Если это невозможно, то Продавец возместит уплаченную цену и транспортные расходы. В любом случае, гарантия Продавца на любой прямой и/или косвенный ущерб, вызванный каким-либо образом дефектной Продукцией, ограничена суммой, которая не может превышать больше, чем в два раза, востребованную Продавцом отпускную цену, и лишь только в отношении к дефектной части поставки.

H.6. Если Покупатель перепродает Продукцию лицам, которые защищены Кодексом потребителя (законодательный декрет № 206/2005), то он несет ответственность за предоставляемые условия, если они отличаются от приведенных здесь, кроме того, он обязан удостовериться в том, что права потребителя защищаются с соблюдением мер и сроков, предусмотренных вышеуказанным Кодексом.При наличии соответствующих предпосылок право регресса и/или право на взыскание убытков, которое Покупатель имеет по отношению к Продавцу/производителю, не может превышать исключения и пределы, установленные в п. 1 раздела G и в п. 5 раздела H.

I. УСЛОВИЯ ОБ ОБЯЗАТЕЛЬНОЙ ОПЛАТЕ (SOLVE ET REPETE) И О ДОСРОЧНОМ ОДНОСТОРОННЕМ РАСТОРЖЕНИИ

I.1. В соответствии со ст. 1462 гражданского кодекса Покупатель не вправе ни по какой причине, в том числе в связи с претензиями по поводу качества или дефектности товара, приостанавливать или задерживать оплату вывезенного материала, сохраняя, тем не менее, право требовать возмещение, если он докажет неправомерное взимание оплаты.

I.2. В случае изменения имущественного положения Покупателя или даже частичной неоплаты уже поставленной Продукции, Продавец может приостановить исполнение текущих поставок и/или расторгнуть текущие договоры, и Покупатель не имеет права потребовать какого-либо возмещения прямых и/или косвенных убытков.

L.- ПОЛОЖЕНИЕ О СОХРАНЕНИИ ПРАВА СОБСТВЕННОСТИ

L.1. Поставляемая Продукция будет оставаться в собственности Продавца до тех пор, пока Покупатель полностью не оплатит ее.

L.2. В течение этого периода Покупатель несет обязательства и ответственность хранителя и не может уступать, предоставлять в пользование, разрешать наложение имущественного ареста или опись Продукции, не заявив, что она находится в собственности Продавца, и не известив его немедленно заказным письмом с уведомлением о вручении.

M.- ФОРС-МАЖОР

M.1. Любая из сторон имеет право приостановить исполнение своих контрактных обязательств, если это исполнение стало невозможным или объективно обременительным по причине непредвиденных событий, находящихся вне ее контроля, таких как, например: забастовка, бойкот, локаут, пожар, война (объявленная или нет), гражданская война, бунт, революция, конфискация, эмбарго, энергетическая блокада, непредвиденный выход из строя оборудования, задержки в поставках компонентов или сырья.

M.2. Сторона, желающая сослаться на настоящее условие, должна немедленно сообщить в письменной форме другой стороне о возникновении и прекращении форс-мажорных обстоятельств.

M.3. Если приостановка в связи с форс-мажорными обстоятельствами продлится более 60 (шестидесяти) дней, то каждая из сторон имеет право расторгнуть настоящий договор, отправив предварительное письменное уведомление об этом другой стороне за 10 (десять) дней.

N.- ОБЯЗАТЕЛЬСТВО О НЕРАЗГЛАШЕНИИ КОНФИДЕНЦИАЛЬНОЙ ИНФОРМАЦИИ

N.1. Покупатель обязан соблюдать максимальную конфиденциальность о всей информации технического характера (такая как, но не ограничиваясь этим, чертежи, проспекты, документация, формулы и переписка) и коммерческого характера (включая договорные условия, отпускные цены, условия платежа и тд.), которая попала в его распоряжение в ходе исполнения настоящего договора.

N.2. Обязательство о неразглашении конфиденциальной информации действует в течение всего срока действия договора, а также в период после его исполнения.

N.3. В случае невыполнения обязательства о неразглашении конфиденциальной информации невыполняющая сторона обязана возместить

O.- ТОРГОВЫЕ МАРКИ И ОТЛИЧИТЕЛЬНЫЕ ЗНАКИ ПРОДАВЦА

O.1. Категорически запрещается использование торговых марок, орнаментальных промышленных образцов и предметов интеллектуальной собственности вообще, в любом виде или форме выражения (например, только в качестве неполного перечня: изображения, фотографии, чертежи, видеосъемки, рисунки, конструкции и тд.), являющихся интеллектуальной собственностью Продавца, в любых СМИ (например, только в качестве неполного перечня: печать, видеоканалы, радиовещание, интернет, социальные сети, платформы для обмена сообщениями или VoIP-платформы). Любое, даже только частичное отступление от этого запрета должно письменно разрешаться в каждом отдельном случае Генеральной дирекцией Продавца.

P.- ЯЗЫК ДОГОВОРА, ПРИМЕНИМЫЙ ЗАКОН, ЮРИСДИКЦИЯ И КОМПЕТЕНЦИЯ

P.1. Договор и настоящие условия составлены на итальянском языке, который преобладает в случае разночтений с переводом на другие языки.

P.2. Любой спор, каким-либо образом связанный с поставками, регулируется итальянским законом и подлежит юрисдикции Итальянского государства, а территориальная компетенция принадлежит исключительно суду г. Модены, в округе которого Продавец имеет свой юридический адрес.

Больше информации можно найти в Общих условиях продажи по адресу www.atlasconcorde.com

MADE IN ITALY

The Made in Italy logo of Atlas Concorde stands for style, quality and ethics. Having firmly adhered to the Ethical Code promoted by Confindustria Ceramica, Atlas Concorde places the Made in Italy logo on all the products designed and produced in Italy, that is to say ceramic tiles, decorations and the majority of special trim tiles. Only a small amount of the latter is manufactured in Spain. Atlas Concorde products are produced using eco-friendly technologies, top quality and safe raw materials with the best working conditions guaranteed for our personnel. For these reasons, Atlas Concorde's Made in Italy is the expression of strong values such as style, design, product quality, and respect for the environment and the people who live in it.

Il marchio Made in Italy di Atlas Concorde è sinonimo di stile, qualità ed etica. Avendo aderito con convinzione al Codice Etico di Confindustria Ceramica, Atlas Concorde appone il marchio Made in Italy su tutti i prodotti studiati, progettati e realizzati in Italia, nella fattispecie tutte le piastrelle di ceramica, le decorazioni e la maggioranza dei pezzi speciali. Solo un ristretto numero di questi ultimi è fabbricato in Spagna. I prodotti Atlas Concorde sono inoltre realizzati con tecnologie rispettose dell'ambiente, utilizzando materie prime eccellenti e sicure, garantendo le migliori condizioni di lavoro. Per queste ragioni il Made in Italy di Atlas Concorde è espressione di valori forti quali stile, design, qualità del prodotto, attenzione all'ambiente e alle persone.

Le label Made in Italy d'Atlas Concorde est synonyme de style, de qualité et d'éthique. Atlas Concorde a adhéré au Code Éthique de Confindustria Céramique avec conviction et appose le label Made in Italy sur tous les produits étudiés, projetés et fabriqués en Italie : dans ce cas, sur tous les carreaux en céramique, les décorations et la plupart des pièces spéciales. Seul un nombre restreint de ces dernières est fabriqué en Espagne. Les produits Atlas Concorde sont en outre fabriqués avec des technologies qui respectent l'environnement et utilisent des matières premières excellentes et sûres, dans la garantie des meilleurs conditions de travail. Pour ces raisons, le Made in Italy d'Atlas Concorde exprime des valeurs fortes telles que le style, le design, la qualité du produit et le respect de l'environnement et des personnes.

La marca Made in Italy de Atlas Concorde es sinónimo de estilo, calidad y ética. Adheriendo con convicción el Código Ético de Confindustria Cerámica, Atlas Concorde señala con la marca Made in Italy todos los productos estudiados, diseñados y realizados en Italia, en este caso todas las baldosas de cerámica, las decoraciones y la mayoría de piezas especiales. Sólo un restringido número de estas últimas se fabrica en España. Los productos Atlas Concorde se realizan además con tecnologías que respetan el medio ambiente, usando materias primas excelentes y seguras, garantizando las mejores condiciones de trabajo. Por dichas razones el Made in Italy de Atlas Concorde es la manifestación de valores sólidos como estilo, diseño, calidad del producto, cuidado del medio ambiente y las personas.

Die Marke Made in Italy von Atlas Concorde ist ein Synonym für Stil, Qualität und Ethik. Aus Überzeugung haben wir uns dem Ethischen Kodex der Confindustria Ceramica (Dachverband der ital. Unternehmen und Unternehmensverbände der Keramikbranche) angeschlossen. Atlas Concorde bringt die Marke Made in Italy auf allen seinen Produkten an die in Italien geplant, entwickelt und realisiert werden, d.h. alle Keramikfliesen, Dekore, Bordüren und der Hauptteil der Spezialteile. Nur eine geringe Anzahl der letzteren werden in Spanien gefertigt. Die Produkte von Atlas Concorde werden darüberhinaus unter Verwendung ausgezeichneter und sicherer Rohstoffe mittels umweltschützender Technologien unter besten Arbeitsbedingungen hergestellt. Aus diesen Gründen ist Made in Italy von Atlas Concorde ein Ausdruck starker Werte wie Stil, Design, Produktqualität.

Маркировка Made in Italy на плитках Atlas Concorde – синоним стиля, качества и этики. С уверенностью приняв «Этический кодекс» федерации Confindustria Ceramica (ассоциация предприятий керамической отрасли), компания отмечает этим знаком все изделия, разработанные и изготовленные в Италии: керамические плитки, декоры и большинство специальных элементов. Лишь ограниченная часть последних производится в Испании. Изделия Atlas Concorde изготовлены с использованием надёжного, высококачественного сырья и передовых технологий, гарантирующих экологическую совместимость производства и оптимальные рабочие условия. Для Atlas Concorde Made in Italy – это выражение важных ценностей, таких как стиль, дизайн, качество. Это уважение к человеку и природе.



The Ceramics of Italy logo is an exclusive identification on ceramic products which have effectively been made in Italy by companies that are a part of the Confindustria Ceramica and who adhered to its Ethical Code. This Code, promoted and created by Confindustria Ceramica, commits all companies to communicate, clearly and with transparency, the origin of their products.

Il marchio Ceramics of Italy contrassegna esclusivamente i prodotti ceramici effettivamente realizzati in Italia da un'azienda associata a Confindustria Ceramica che ha sottoscritto il Codice Etico. Il Codice, redatto dalla stessa Confindustria Ceramica, impegna a comunicare con chiarezza l'origine dei prodotti.

Le label Ceramics of Italy distingue exclusivement les produits en céramique qui sont effectivement fabriqués en Italie par les sociétés associées à Confindustria Céramique ayant souscrit le Code Éthique. Ce Code, rédigé par Confindustria Céramique, engage ceux qui le souscrivent à communiquer clairement l'origine des produits.

Die Marke Ceramics of Italy zeichnet ausschließlich Keramikprodukte aus, die in Italien, von Unternehmen, welche dem Dachverband der ital. Unternehmen und Unternehmensverbände der Keramikbranche angehören und sich dem Ethischen Kodex verschrieben haben, hergestellt werden. Der Kodex, von diesem Dachverband ins Leben gerufen, verpflichtet sich zur klaren Angabe und Mitteilung der Herkunft der Produkte.

La marca Ceramics of Italy distingue exclusivamente los productos cerámicos realizados efectivamente en Italia por una empresa afiliada a Confindustria Cerámica que ha suscrito el Código Ético. El Código, redactado por Confindustria Cerámica, compromete a quien lo ratifica a comunicar con claridad el origen de los productos.

Знаком Ceramics of Italy маркируются только керамические изделия, которые изготовлены действительно в Италии предприятием-членом федерации Confindustria Ceramica, подписавшим «Этический кодекс». Кодекс разработан самой федерацией и обязывает ясно указывать происхождение товара.

NOTES | NOTE

Notes | Anmerkungen

Notas | Примечание

Atlas Concorde reserves the right to modify any product without notice and will not be liable for any direct or indirect damage resulting from such modifications.

Atlas Concorde si riserva di modificare i prodotti senza preavviso, declinando ogni responsabilità su eventuali danni diretti o indiretti derivanti da eventuali modifiche. / Atlas Concorde se réserve le droit de modifier ses produits sans préavis et décline toute responsabilité concernant les éventuels dommages directs ou indirects qui pourraient dériver de ces modifications | Atlas Concorde behält sich das Recht vor jederzeit und ohne vorherige Ankündigung, die Produkte zu verändern, und lehnt jede Haftung bei direkten oder indirekten Schäden ab, die von diesen Veränderungen herrühren | Atlas Concorde se reserva el derecho de modificar los productos sin previo aviso, rechaza cualquier responsabilidad sobre eventuales daños directos o indirectos derivados de eventuales modificaciones | Atlas Concorde оставляет за собой право изменять характеристики изделий без предварительного уведомления, отклоняя при этом любую ответственность за прямые или косвенные убытки, возникшие в результате изменений.

Colours and optical features of the materials illustrated in this catalogue are to be regarded as mere indications.

I colori e le caratteristiche estetiche dei materiali illustrati nel presente catalogo sono da ritenersi puramente indicativi. / Les coloris et les caractéristiques esthétiques des références illustrées dans le catalogue sont donnés à titre purement indicatif | Die Farben und die ästhetischen Eigenschaften der in diesem Katalog abgebildeten Produkte sind als reine Richtwerte zu betrachten | Los colores y las características estéticas de los materiales ilustrados en el presente catálogo deben ser considerados como puramente indicativos | Цвета и эстетические характеристики описанных в настоящем каталоге материалов являются только ориентировочными.

For information and details relating to codes, packaging and weight it is recommended to refer to the latest pricelist.

Per le informazioni e i dati relativi a codici, imballaggi e pesi occorre sempre consultare l'ultimo listino aggiornato e in vigore. / Pour toutes informations et renseignements concernant les codes, les emballages et les poids, il y a toujours lieu de consulter le dernier tarif en vigueur et mis à jour | Für Informationen und Daten die den Code, die Verpackung und das Gewicht betreffen bitte die aktuellste Preisliste zugrunde legen | Para acceder a la información y a los datos relativos a códigos, embalajes y pesos hay que consultar siempre la última lista de precios actualizada y vigente | Для информации о кодах, упаковках и весе обращайтесь к последнему действующему прайс-листу.

Ceramic products can have slight variations in tone. Check with the sales representative for the possibility of combining production lots, formats, decorations and special pieces.

Il prodotto ceramico può essere leggermente variabile in termini di toni. Verificare con il referente commerciale l'abbinabilità sia tra i lotti produttivi che tra i formati e i decori o i pezzi speciali. /Le produit céramique peut légèrement différer sur l'aspect de la couleur. Vérifier avec le référent commercial que l'assortiment soit entre les lots de fabrication qu'entre les formats et les décors ou les pièces spéciales | Im keramischen Produkt sind Abweichungen von Farbton möglich. Wenden Sie sich bitte an den Verkaufsleiter, um zu überprüfen, wie man die verschiedenen Posten, Formate, Dekore oder Spezialteile miteinander kombinieren kann | El producto cerámico puede variar levemente en lo que respecta a los tonos. Consulte con el representante de ventas la combinación entre los lotes producidos y entre los formatos y las decoraciones o las piezas especiales | Керамические изделия разных партий могут слегка отличаться по тону. Проверьте вместе с торговым представителем сочетаемость с изделиями других партий, а также с форматами, декоративными или специальными элементами.

The production sizes of special pieces in porcelain tiles may vary from the nominal sizes provided for in current standards (ISO 13006 – EN 14411 Annex G) for non-modular tiles.

Le dimensioni di fabbricazione dei pezzi speciali in gres porcellanato possono derogare dalle dimensioni nominali previste dalle normative vigenti (ISO 13006 - EN 14411 appendice G) per le piastrelle non modulari. / Les dimensions de fabrication des pièces spéciales en grès cérame peuvent déroger aux dimensions nominales prévues par les règlements en vigueur (ISO 13006 - EN 14411 annexe G) pour les carreaux non modulaires. | Die Produktionsmaße der Formteile aus Feinsteinzeug können für die nicht modularen Fliesenformate von den Sollmaßen der geltenden Normen (ISO 13006 - EN 14411 Anhang G) abweichen. | Los tamaños de fabricación de las piezas especiales de gres porcelánico pueden ser diferentes de las dimensiones nominales previstas por las normas vigentes (ISO 13006 - EN 14411 aréndice G) para las baldosas no modulares. | Производственные размеры специальных элементов из керамогранита могут отклоняться от номинальных размеров, предусмотренных действующими стандартами (ISO 13006 - EN 14411, Приложение G) для немодульных плиток.

The actual dimensions of the special pieces and the smaller pieces obtained by cutting porcelain tiles could deviate from the tolerances in the catalog, which instead for the rectified formats are guaranteed by Atlas Concorde.

Le dimensioni reali dei pezzi speciali e dei sottoformati ottenuti da tagli in gres porcellanato potrebbero derogare rispetto alla tolleranze presenti a catalogo garantite da Atlas Concorde sui formati rettificati. / Les dimensions réelles des pièces spéciales et des sous formats obtenus à partir des coupes en grès cérame pourraient varier par rapport aux tolérances présentes au catalogue garanties par Atlas Concorde sur les formats rectifiés. | Die tatsächlichen Abmessungen der Formstücke und der geschnittenen Unterformate aus Feinsteinzeug können von den im Katalog genannten, von Atlas Concorde für rektifizierte Formate garantierten Toleranzen abweichen. | Las dimensiones reales de las piezas especiales y de los subformatos obtenidos por cortes de gres porcelánico, podrían no cumplir con las tolerancias indicadas en el catálogo, garantizadas por Atlas Concorde para los formatos rectificados. | Фактические размеры специальных элементов и подформатов, полученных путем разрезания керамогранита, могут отклоняться от допусков, указанных в каталоге и гарантируемых компанией Atlas Concorde для ретифицированных форматов.

Copyright 2020 by Ceramiche Atlas Concorde S.p.A - The reproduction of the work, fully or in part, is strictly forbidden.

Copyright 2020 by Ceramiche Atlas Concorde S.p.A - È vietata la riproduzione, anche parziale, dell'opera in tutte le sue forme.

Copyright 2020 by Ceramiche Atlas Concorde S.p.A - Toute reproduction, même partielle, de l'œuvre dans toutes ses formes est interdite.

Copyright 2020 by Ceramiche Atlas Concorde S.p.A - Die Reproduktion, ganz oder teilweise, des Werkes in all seinen Formen ist verboten

Copyright 2020 by Ceramiche Atlas Concorde S.p.A - Está prohibida la reproducción, incluso parcial, de la obra en todas sus formas.

Copyright 2020 by Ceramiche Atlas Concorde S.p.A - Запрещается любое полное или частичное воспроизведение данной работы.



Ceramiche Atlas Concorde S.p.A.
Via Canaletto 141
41042 Spezzano di Fiorano (MO) – Italia

Atlas Concorde USA, Inc.
117 Seaboard Lane – Suite F170
Franklin, TN 37067 – USA

Atlas Concorde Russia
Business centre “Meliora Place”
Prospekt Mira 6
129090 Moscow – Russia

atlasconcorde.com