

*Burlington*<sup>®</sup>



*Burlington®*

From the late 1800's into the 1900's, Britain led the way in bathroom design and performance. Our time honoured Burlington and Arcade bathrooms bring a complete collection of traditional products all with modern functionality. These ranges allow you to create a traditional bathroom that can reflect the historical eras of great design across Edwardian, Victorian, Classic, Contemporary or Arcade's unique Belle Époque style.

The latest technology is utilised throughout the Burlington and Arcade product ranges to bring important benefits such as stay-clean Nano glaze coating on all WC bowls, ceramic disc options on all brassware and all showers with safe thermostatic operation.

Our extensive portfolio is designed to solve all your design challenges with a vast range of models that will suit every plumbing installation. Bathroom furniture, that provides many storage solutions, can complete the look you want and is available in four finishes. See the Technical Directory which starts on page 60 for the complete choice. Whatever you choose you can be sure Burlington and Arcade products will work perfectly together.

<i>INSPIRATION</i>	<i>pages 02-59</i>	<i>BATHS</i>	<i>pages 132-151</i>
<i>BASINS</i>	<i>pages 62-93</i>	<i>BRASSWARE</i>	<i>pages 152-169</i>
<i>WCs</i>	<i>pages 94-113</i>	<i>SHOWERING</i>	<i>pages 170-189</i>
<i>FURNITURE</i>	<i>pages 114-131</i>	<i>ACCESSORIES</i>	<i>pages 190-200</i>







Your bathroom space should be one in which you feel completely at home, a space that reflects your unique personality and individual tastes. It's a space for rejuvenation, pampering, relaxation as well as an environment for the necessities of a daily routine.

You may already have an idea of the style of bathroom you're looking to create or you may need further guidance to help you configure your ideal traditional bathroom. The following pages in this brochure have been designed to help inspire with some of our suggested product pairings. Or you may spot something you can mix and match with product on subsequent pages. However you configure your beautifully traditional bathroom, we're sure you'll find just what you're looking for from Burlington and Arcade bathrooms.



Edwardian 1200mm basin with washstand and Claremont three tap hole basin mixer with pop-up waste.



*CLASSIC INVISIBLE OVERFLOW BASIN*

Our products are faithful reproductions of historical designs. This Classic basin is based on a model called Cliffe Vale produced in 1896 and described at the time as “a basin with improved waste and overflow”. It’s unique waste means there is no requirement for a plug or external waste. Simply pull the lever up to drain water.



Classic 650mm basin with invisible overflow, classic pedestal and Claremont two tap hole 5" basin taps. Tumbler holder and towel ring.





Our furniture is a beautiful representation of traditional design available in 5 classic yet contemporary colours perfect for the modern day bathroom; Matt White, Sand, Dark Olive, Classic Grey or NEW Blue. Seamlessly carry through your colour selection to bath surrounds and WC seats for a consistent look.

*AVAILABLE FURNITURE COLOURS*



**Above:** Classic 510mm basin, freestanding Matt White cloakroom vanity unit with single door and Chelsea straight basin mixer with pop-up waste.



Classic Grey 1340mm Curved freestanding vanity unit, Carrara White worktop and Kensington regent three tap hole basin mixer with pop up waste. Arched mirror and ornate lights with vase shades.

*INTRODUCING BLUE FURNITURE*

Pair with elegant neutral tones and Gold brassware for a stunning impact.

1340mm Blue curved freestanding vanity unit, Minerva Carrara marble worktop and Claremont three tap hole basin mixer with pop-up waste and Regent tap bases, Gold. Blue 1200 mirror with LED illuminations. Standard low level WC, 520mm lever cistern in Gold, with Blue soft-close seat, Gold WC roll holder and Gold Towel ring.









**Above:** Edwardian 560mm Basin & Blue Freestanding Rectangular Cloakroom Vanity Unit shown with Nickel handle, and Claremont basin mixer with high central indice and click clack waste, Nickel. 600 mirror with LED illuminations and Soap dish, Nickel.

Classic 650mm Basin & Blue Freestanding Vanity Unit with doors shown with Gold handles, and Claremont basin mixer with high central indice and click clack waste, Gold.





*GOLD AND NICKEL BRASSWARE FINISHES*

Choose Nickel to bring a truly traditional feel or opt for the stunning Gold finish to add a sense of opulence and grandeur to your bathroom. Available in selected products in the existing Burlington range.





**Left:** 1650mm Admiral double-ended bath and Kensington floor-standing bath shower mixer with exposed waste and overflow, Gold.  
**Above:** Claremont three tap hole basin mixer with pop-up waste and Regent tap bases, Gold. Claremont basin mixer with high central indice and click clack waste, Nickel

*JET IS THE NEW BLACK*

Dare to be different with ceramic basins and WCs, finished in a lustrous gloss Black, for a versatile yet refined trend statement that refuses to go out of fashion. With basins available in 4 sizes across our distinctive Edwardian and Classic styles, you can select the perfect solution for your space.





**Right:** Jet Edwardian 515mm cloakroom basin with chrome washstand and Claremont 3" taps with Black indices and plug and chain waste. **Below:** Jet Edwardian 515mm cloakroom basin with Edwardian cloakroom furniture unit with Claremont 3" taps with Black indices and plug and chain waste. W.C roll holder in chrome. Jet close coupled WC with 520mm lever cistern and Black soft close seat.







Jet high level WC with single flush ceramic cistern, flush pipe kit and Black soft-close seat. Claremont three tap hole mixer with pop-up waste and Black indices. Jet Edwardian 1200mm basin with chrome basin stand. WC roll holder, Black WC brush holder and Black tumbler holder.



Jet Classic two tap hole basin with Kensington 5" taps and Black indices.



Jet Classic two tap hole 650mm basin with Black Aluminium washstand. Kensington 5" basin taps with Black levers and indices and chrome bottle trap.



*CREATE A STUNNING STATEMENT IN BLACK*

For added flair, select the brassware with Black ceramic levers and indices. There are coordinating Black products available across toilet seats, aluminium washstands, high level cisterns, radiators, mirrors and bath feet to create a dramatic bathroom statement.





Carrara marble basin, Black aluminium washstand with shelf, Kensington Black three tap hole basin mixer, Black aluminium mirror, towel ring and round lights with chiffon shades. Standard high level WC with soft-close Matt Black seat, dual flush Black aluminium cistern and spire toilet roll holder. Bateau bath with claw Black feet.





Bateau bath with claw Black feet and Kensington Black bath shower mixer on stand pipes.



High level Black aluminium cistern.

*THE MEDICI COLLECTION*

In 1929, the Standard Sanitary Corporation of America introduced a luxury bathroom colour, Ivoire De Medici, said to “have brought the warmth of sunlight to the bathroom decor”. This ‘mellow tint of old ivory’ was first achieved by Italian potters who worked under the patronage of the famous de Medici family in Florence.





**Right:** Medici medium level WC with 520mm lever cistern, flush pipe kit and Medici soft close seat. Medici Classic rectangular 650mm basin and chrome basin stand with Medici Claremont two tap hole 5" taps and plug and chain basin waste. **Below:** Medici Edwardian cloakroom two tap hole basin and freestanding Sand cloakroom vanity unit with Medici Claremont two tap hole 3" taps and plug and chain basin waste.





Medici Batello grande bath,  
Medici Claremont bath  
shower mixer and stand  
pipes. Medici Claremont  
basin mixer with high central  
indice and click clack waste.  
Arched mirror with Ornate  
lights with vase shades.  
Medici Edwardian 1200mm  
basin with basin stand.  
Medici close coupled WC  
with 520mm cistern lever  
and Medici soft close seat.







*THE WALNUT COLLECTION*

For a premium option, select the Walnut trim for your Kensington taps, cistern lever or bath shower mixer. There are coordinating solid Walnut products available across toilet seats, brassware and accessories, to add the finishing touches to your traditional bathroom.



**Left:** Classic 650mm rectangular basin with Kensington Walnut three tap hole basin mixer. **Top Right:** Tumbler holder with Walnut back plate. **Lower Right:** Edwardian 515mm rectangular cloakroom basin with Kensington Walnut 3" taps.





*THE EDWARDIAN COLLECTION*

The Edwardian basin design has a refined structure with strong lines and an impressive stance. Available in a range of sizes; 560mm in either a rectangular or a round design, or 610mm, 800mm and 1200mm rectangular basins each available with corresponding pedestals and washstands.





**Left:** Edwardian 560mm basin, standard pedestal and Birkenhead two tap hole 5" pillar taps and plug and chain basin waste. Standard close-coupled WC with 520mm lever cistern and White soft-close seat.

*THE STUNNING LONDON BATH*

The double-ended London Round has a simple purity of form that will enhance any style of décor in your home.







London Round soaking tub and  
Black Kensington bath shower  
mixer on stand pipes.



Edwardian 800mm basin, traditional bottle trap, chrome washstand and Birkenhead three tap hole basin mixer.



Standard low level WC with 520mm lever cistern, White soft-close seat and WC toilet roll holder.



*THE ARCADE COLLECTION*

Arcade is a timeless collection and provides the ultimate in luxurious bathroom styling, Arcade's ranges of exquisitely crafted pieces are lovingly hand finished to achieve an iconic Belle Époque appearance. Choose from fixtures and fittings in either chrome or nickel for a truly individual look.



**Above:** 500mm Cloakroom basin, bottle trap and Mini crosshead basin mixer.

**Right:** Open back close-coupled WC, dual flush cistern and Gloss Black soft-close seat. 900mm basin with overflow, chrome bottle trap, chrome stand, three tap hole deck-mounted basin mixer with chrome levers.







*THE BALTHAZAR BATH*

The Balthazar, crafted from ClearStone is a double-ended bath providing an eye-catching centrepiece to your bathroom with its lustrous, glossy interior and stainless steel outer. Also available with pure White outer or intense Black outer. See page 134 for all finishes.



Balthazar bath in ClearStone with stainless steel outer and Kensington bath shower mixer on stand pipes.

## *FREESTANDING OR FITTED FURNITURE*

Our traditional storage solutions add a sophisticated elegance to your bathroom. Whether you prefer a square or curved design, freestanding options or a fitted furniture solution combining base units such as basin and WC units, full height storage and wall units to fit your designated space.

## *AVAILABLE FURNITURE COLOURS*



1300mm freestanding vanity unit with doors, Minerva copper fleck double vanity bowl with two Chelsea basin mixers and two arched mirrors.

600mm mirrored double door wall unit, 600mm double door wall unit, 300mm single door wall unit, 600mm base unit for semi-recessed basin, semi-recessed 580mm basin, Chelsea basin mixer, 600mm WC unit, wall-hung WC and Matt White soft-close seat. Two Minerva Carrara White 1200mm worktops and joining kit. Towel ring and Trafalgar radiator.







*THE VICTORIAN COLLECTION*

This versatile basin features a delicate and refined edge with a simplicity that blends beautifully with its surroundings. Available in both 560mm and 610mm sizes with a range of pedestal and washstand options.



**Left:** 610mm Victorian basin, standard pedestal and Claremont 5" basin taps. Rectangular mirror and Bloomsbury radiator.

**Above left:** 650mm Natural stone basin, stainless steel basin stand, traditional bottle trap, Claremont basin mixer with pop-up waste and rectangular mirror.

**Above right:** 610mm Victorian basin, chrome washstand, traditional bottle trap, Claremont basin mixer with pop-up waste and tumbler holder.







580mm Contemporary basin, semi-pedestal and Claremont basin mixer. Triple robe hook, single soap dispenser, ornate lights with chrome bases and tube frosted glass shades and WC roll holder. Wall-hung WC, Sand soft-close seat with concealed cistern and WC brush holder. Arundel bath, plug and chain bath waste with Sand front and end panels and Claremont deck-mounted bath filler.

*EDWARDIAN ROUND*

The Edwardian round basin combines strength of character with a soft, balanced nature. Available as a 560mm size with either one or two tap holes, it can be paired with pedestals or chrome washstands in standard and regal heights.

560mm Edwardian round basin, chrome washstand and Kensington 5" taps with plug and chain waste. Tumbler holder.









**Left:** 560mm Edwardian round basin and chrome washstand with Kensington 5" taps, plug and chain waste and tumbler holder. Back-to-wall WC, White soft-close seat, concealed cistern with lever and spare WC roll holder.

**Above:** Blenheim bath, White arc feet and deck-mounted Kensington bath shower mixer with 'S' adjuster and plug and chain waste.







510mm Classic square basin, chrome washstand and Claremont 3" pillar taps with plug and chain waste and soap dish.



#### *THE CLASSIC COLLECTION*

The Classic basin collection features a 510mm square design, which is available with a corresponding cloakroom furniture unit or standard chrome washstand. Our 650mm rectangular basins are available as one, two, or three tap hole options. Pair with pedestals, furniture or on chrome or aluminium washstands. A 650mm round design is also available with one, two or three tap holes and can be paired with a simple, ceramic pedestal.







1340mm White curved freestanding vanity unit, Minerva Carrara marble worktop and Kensington three tap hole basin mixer with pop-up waste. Arched mirror and Burlington round lights with chrome bases and vase clear glass shades. Standard medium level WC, 520mm lever cistern, White soft-close seat and WC roll holder.







**Left:** 650mm Classic rectangular basin, traditional bottle trap, distressed aluminium washstand and Claremont 5" taps. Distressed aluminium frame mirror.

**Above:** 1650mm Admiral double-ended bath and Kensington floor-standing bath shower mixer with exposed chrome waste and overflow.

## *FINISHING TOUCHES*

Our range of accessories will provide the finishing touches to ensure your bathroom looks and functions perfectly. From classically styled chrome soap dishes, to ceramic toothbrush holders, every item is traditionally crafted in chrome plated solid brass, to guarantee the balance of functionality and style. Selected models now available in Gold and Nickel.

*FOR OUR FULL RANGE OF ACCESSORIES SEE PAGE 192*







Left: Tumbler holder, Gold  
Above: Glass shelf with railing



Standard high level WC, dual flush White aluminium cistern and White soft-close seat. 560mm Edwardian round basin, traditional bottle trap, chrome washstand and Claremont 5" taps with plug and chain waste. Hampton 1500mm left-handed bath,

chrome arc feet, bath screen with access panel and Claremont deck-mounted bath filler with plug and chain waste. Corner basket.





## *BURLINGTON SHOWERING*

Our extensive range of showering options ensures the perfect solution for your bathroom. Whether you are showering over a bath, or in a separate shower, our thermostatic valves have the latest in safe operation. We use the latest technology in all our shower mixers for the fastest and safest response. Selected ranges now available in Gold or Nickel finishes.



**Right:** Black Trent thermostatic dual function brass valve with independent flow diverter and temperature control. Traditional brass faceplate and Claremont handle with ceramic lever. Wall outlet and 1500mm shower hose. Adjustable wall bracket and handset with ceramic handle. 390mm adjustable shower arm.



# *TECHNICAL DIRECTORY*

You have now been introduced to the wide scope of the Burlington and Arcade ranges, all designed and engineered to provide solutions for your bathroom. The following Technical Directory provides a full listing of the Burlington and Arcade products including product codes and dimensions. Visit our website [burlingtonbathrooms.com](http://burlingtonbathrooms.com) or for our full database [bbwhitebook.com](http://bbwhitebook.com) if you need further details. Whatever you choose, we are sure you will be delighted with your traditional bathroom by Burlington.



62 *BASINS*

94 *WCs*

114 *FURNITURE*

132 *BATHS*

152 *BRASSWARE*

170 *SHOWERING*

190 *ACCESSORIES*

# *BASINS*





### Classic



The Classic collection from Burlington is beautifully formed, available in round or square designs, complete with an invisible waste option.

### Edwardian



The Edwardian collection is the ultimate in traditional bathrooms with structured corners and angular designs, the feel is unapologetic and proud.

### Victorian



Delicate and refined, the simplicity of this basin is stunning whilst its versatility allows you to continue the style through your home and brings an air of luxury.

### Contemporary



As the name suggests, the Contemporary collection is styled on the elegance of past times but with a modern day twist. Simplistic, structured lines form the basis for this striking ceramic collection.

### Cloakroom



A choice of traditionally designed cloakroom basins to achieve a consistent look throughout the home.

\*The lifetime guarantee is subject to online registration and represents the perceived lifetime of the product which is 25 years. For full details on guarantees please visit [burlingtonbathrooms.com/guarantee](http://burlingtonbathrooms.com/guarantee).



*BASIN OPTIONS*

Burlington Regal pedestals are higher than standard pedestals, making them more comfortable for taller people, the elderly or those prone to back pain.



	Standard	Regal
Classic	860mm	920mm
Victorian	840mm	900mm
Edwardian	840mm	900mm
Contemporary	840mm	900mm

*WASHSTAND OPTIONS*

Our chrome washstands are also available in a Regal height and are compatible with Classic, Edwardian, Victorian, Contemporary, Cloakroom and Georgian basins. With an increased height of 60mm, they provide an ergonomic use for taller people and those who need it.



Regal



Standard



Towel Rack

Some of our washstands are now available with an optional towel rack.

## CLASSIC ROUND & SQUARE BASINS

Select your basin shape



Classic 650mm round basin



Classic 510mm square basin



Classic 650mm round basin shown with classic pedestal

W: 650 D: 580 H: 860

Basin: B17\*  
Pedestal: P6



Classic 510mm square basin shown with standard chrome washstand

W: 510 D: 450 H: 890

Basin: B20\*\*  
Washstand: T52 CHR

### ONE, TWO, OR THREE TAP HOLE



Select the brassware look you prefer with a choice of 1, 2 or 3 tap hole basins. Simply add 1TH, 2TH or 3TH to the end of your desired basin code. See page 152 to choose your corresponding brassware.

\* The Classic 650mm round basin is available with one, two or three tap holes. To order the correct basin configuration simply replace '\*\*' with 1TH, 2TH or 3TH.

\*\* Classic 510mm basin only available in 1TH or 2TH configuration

## CLASSIC RECTANGULAR BASINS

Select your basin shape



Classic 650mm rectangular basin shown with distressed aluminium washstand

W: 650 D: 575 H: 860

Basin: B15\*  
Washstand: T38 ALU



Classic 650mm rectangular basin shown with Black aluminium washstand

W: 650 D: 575 H: 860

Basin: B15\*  
Washstand: T48 BLA



Classic 650mm rectangular basin shown with White aluminium washstand

W: 650 D: 575 H: 860

Basin: B15\*  
Washstand: T43 WHI



Classic 650mm rectangular basin shown with chrome washstand

W: 650 D: 575 H: 860

Basin: B15\*  
Washstand: T49A CHR

\* Classic basins are available with one, two or three tap holes. To order the correct basin configuration simply replace '\*' with 1TH, 2TH or 3TH.





Classic 650mm rectangular basin shown with classic pedestal

W: 650 D: 575 H: 860

Basin: B15\*  
Pedestal: P6

### OPT FOR A TALLER BASIN INSTALLATION

Basin shapes	Size	Regal round pedestal	Regal chrome washstand
Rectangular	650 x 575	P9R	T49A CHR+T62
Round	650 x 575	P9R	
Square	510 x 450		T52 CHR+T62



Regal round pedestal



Regal chrome washstand

**nanoGLAZE**  
ceramic that stays cleaner

Classic basins feature a unique stay-clean NANO Glaze coating, creating an ultra-smooth surface, six times smoother than standard ceramic.

\* The Classic 650mm rectangular basin is available with one, two or three tap holes. To order the correct basin configuration simply replace '\*' with 1TH, 2TH or 3TH.



***INVISIBLE OVERFLOW WASTE***

Available with the Classic collection as a two tap hole configuration

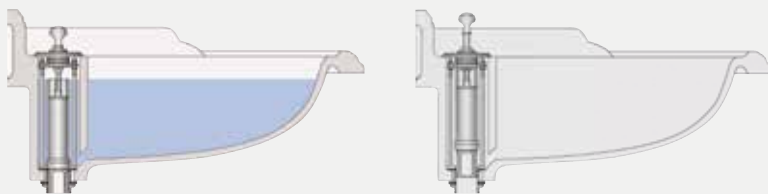

The benefit of invisible overflow is that the ceramic of the beautiful basins is un-interrupted with no requirement for a plug or external waste. Simply pull the lever to drain water. Pair with the elegant and beautiful Arch basin mixer allowing you to mix hot and cold water.

***TWO TAP HOLE OPTION***



Turn to page 152 to see the two tap hole options that can be paired with your Classic invisible overflow basin.

## CLASSIC INVISIBLE OVERFLOW BASINS



Classic 650mm rectangular invisible overflow basin shown with classic pedestal

W: 650 D: 575 H: 860

Basin: B14\*  
Pedestal: P6



Classic 650mm rectangular invisible overflow basin shown with distressed aluminium washstand

W: 650 D: 575 H: 860

Basin: B14\*  
Washstand: T38 ALU



Classic 650mm rectangular invisible overflow basin shown with Black aluminium washstand

W: 650 D: 575 H: 860

Basin: B14\*  
Washstand: T48 BLA



Classic 650mm rectangular invisible overflow basin shown with White aluminium washstand

W: 650 D: 575 H: 860

Basin: B14\*  
Washstand: T43 WHI



Classic 650mm rectangular invisible overflow basin shown with chrome washstand

W: 650 D: 575 H: 860

Basin: B14\*  
Washstand: T49A CHR



Classic basin invisible overflow and waste

W: 300 D: 74 H: 74

Code: W9

### OPT FOR A TALLER BASIN INSTALLATION

Basin shapes	Size	Regal round pedestal	Regal chrome washstand
Rectangular	650 x 575	P9R	T49A CHR+T62



Regal round pedestal

920mm



Regal chrome washstand

920mm

\* This Classic basin choice is only compatible with 2TH. To order the correct basin configuration simply replace \*\* with 2TH.



## EDWARDIAN BASINS

Select your basin shape



Edwardian 560mm rectangular basin shown with chrome washstand

W: 560 D: 470 H: 840

Basin: B4\*

Washstand: T22A CHR

Edwardian 610mm rectangular basin shown with chrome washstand

W: 610 D: 510 H: 840

Basin: B5\*

Washstand: T23A CHR

Edwardian 800mm rectangular basin shown with chrome washstand

W: 800 D: 510 H: 840

Basin: B18\*

Washstand: T50 CHR

Edwardian 1200mm rectangular basin shown with chrome washstand

W: 1200 D: 510 H: 840

Basin: B19\*

Washstand: T51 CHR

Optional Extra for T22A CHR and T23A CHR

We now offer an additional towel rack to add to your washstand. Please order the below:

T22A-S

T23A-S

\*Edwardian Rectangular basins are available with one, two or three tap holes. To order the correct basin configuration simply replace "\*" with 1TH, 2TH or 3TH. 3 tap hole basins and the 800mm and 1200mm basin cannot be used with the semi-pedestal.



Edwardian 560mm rectangular basin shown with standard pedestal

W: 560 D: 470 H: 840

Basin: B4\*  
Pedestal: P1

Edwardian 610mm rectangular basin shown with standard pedestal

W: 610 D: 510 H: 840

Basin: B5\*  
Pedestal: P1

Edwardian 800mm rectangular basin shown with classic pedestal

W: 800 D: 510 H: 840

Basin: B18\*  
Pedestal: P6

Edwardian 1200mm rectangular basin shown with classic pedestal

W: 1200 D: 510 H: 840

Basin: B19\*  
Pedestal: P6

· NEW ·



Edwardian 1200mm double basin shown with chrome washstand

W: 1200 D: 510 H: 840

Basin: B21\*  
Washstand: T51 CHR

*OPT FOR A TALLER BASIN INSTALLATION*

Basin shapes	Size	Regal pedestal	Regal chrome washstand
Rectangular	560 x 470	P9	T22A CHR+T62
Rectangular	610 x 510	P9	T23A CHR+T62
Rectangular	800 x 510	P9R	T50 CHR+T62
Rectangular	1200 x 510	P9R	T51 CHR+T62
Round	560 x 470	P9	T24A CHR+T62

\*Edwardian 560mm and 610mm Rectangular basins are available with regal pedestal P9. Edwardian 800mm and 1200mm basins are available with regal round pedestal P9R as displayed opposite.



Regal pedestal (P9)



Regal chrome washstand

\*Edwardian Rectangular basins are available with one, two or three tap holes. To order the correct basin configuration simply replace '\*' with 1TH, 2TH or 3TH. 3 tap hole basins and the 800mm and 1200mm basins cannot be used with the semi-pedestal.



Edwardian 560mm rectangular basin shown with semi-pedestal

W: 560 D: 470

Basin: B4\*  
Pedestal: P8



Edwardian 610mm rectangular basin shown with semi-pedestal

W: 610 D: 510

Basin: B5\*  
Pedestal: P8

### TOWEL RAILS



Add a towel rail to your basin.

#### Rectangular

560mm basin  
T1 CHR  
610mm basin  
T3 CHR

#### Round

560mm basin  
T4 CHR



## *EDWARDIAN BASINS*

Select your basin shape

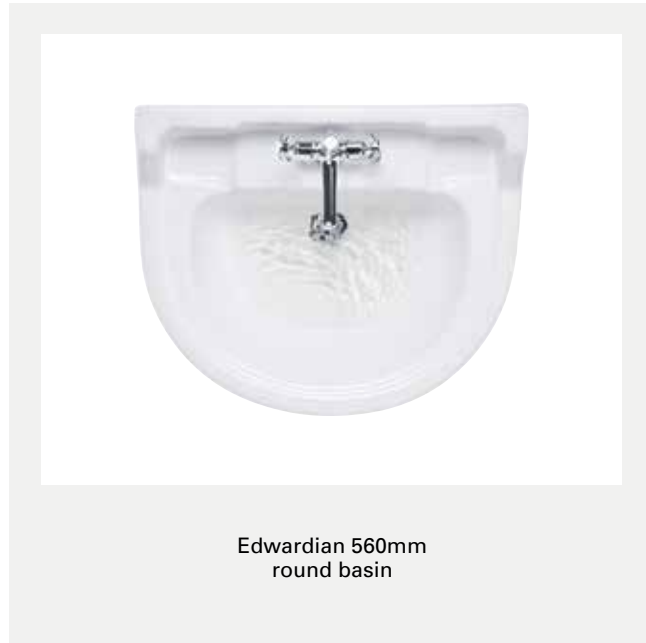

Edwardian 560mm round basin shown with standard pedestal

W: 560 D: 470 H: 840

Basin: B6\*  
Pedestal: P1



Edwardian 560mm round basin shown with chrome washstand

W: 560 D: 470 H: 840

Basin: B6\*  
Washstand: T24A CHR

### *ONE OR TWO TAP HOLE*



Select the brassware look you prefer with a choice of 1 or 2 tap hole basins. Simply add 1TH or 2TH to the end of your desired basin code. See page 152 to choose your corresponding brassware.

\*Edwardian round basins are available with one or two tap holes. To order the correct basin configuration simply replace '\*' with 1TH or 2TH.

## VICTORIAN BASINS

Select your basin shape



Victorian 560mm  
basin shown with  
standard pedestal

W: 560 D: 470 H: 840

Basin: B2\*  
Pedestal: P1



Victorian 610mm  
basin shown with  
standard pedestal

W: 610 D: 510 H: 840

Basin: B3\*  
Pedestal: P1



Victorian 560mm  
basin shown with  
semi-pedestal

W: 560 D: 470

Basin: B2\*\*  
Pedestal: P8



Victorian 610mm  
basin shown with  
semi-pedestal

W: 610 D: 510

Basin: B3\*\*  
Pedestal: P8

\* Victorian basins are available with one, two or three tap holes. To order the correct basin configuration simply replace '\*\*' with 1TH, 2TH or 3TH.  
\*\* 3TH basins cannot be used with semi-pedestals



**Victorian 560mm basin shown with chrome washstand**  
 W: 560 D: 470 H: 840  
 Basin: B2\*  
 Washstand: T22A CHR

**Victorian 610mm basin shown with chrome washstand**  
 W: 610 D: 510 H: 840  
 Basin: B3\*  
 Washstand: T23A CHR

*OPT FOR A TALLER BASIN INSTALLATION*

Basin shapes	Size	Regal pedestal	Regal chrome washstand
Rectangular	560 x 470	P9	T22A CHR+T62
Rectangular	610 x 510	P9	T23A CHR+T62



**Optional Extra for T22A CHR and T23A CHR**  
 We now offer an additional towel rack to add to your washstand. Please order the below:  
 T22A-S  
 T23A-S

*ONE, TWO, OR THREE TAP HOLE*



Select the brassware look you prefer with a choice of 1, 2 or 3 tap hole basins. Simply add 1TH, 2TH or 3TH to the end of your desired basin code. See page 152 to choose your corresponding brassware.

*TOWEL RAILS*



Add a towel rail to your basin.

560mm basin  
 T1 CHR  
 610mm basin  
 T3 CHR

\* Victorian basins are available with one, two or three tap holes. To order the correct basin configuration simply replace '\*\*' with 1TH, 2TH or 3TH.  
 \*\* 3TH basins cannot be used with semi-pedestals

## CONTEMPORARY BASINS

Select your basin shape

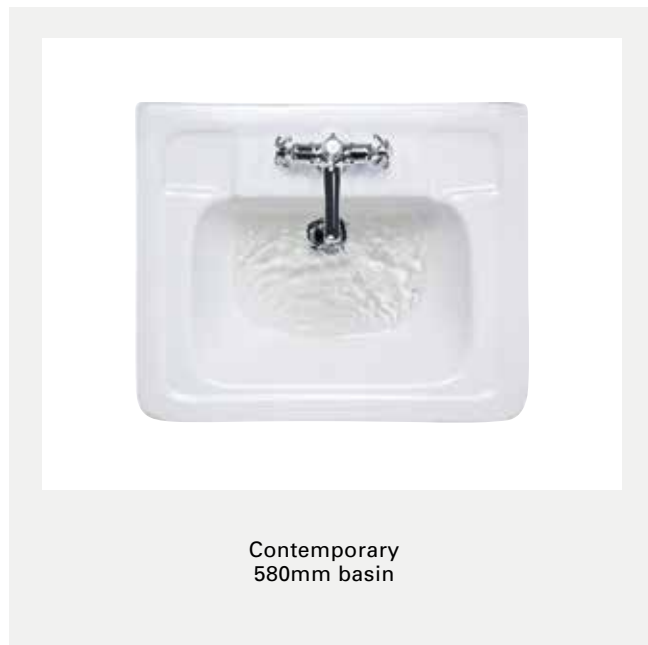

Contemporary 580mm  
basin shown with  
standard pedestal

W: 580 D: 470 H: 840

Basin: B1\*  
Pedestal: P1



Contemporary 580mm  
basin shown with  
semi-pedestal

W: 580 D: 470

Basin: B1\*  
Pedestal: P8



Contemporary 580mm  
basin shown with chrome  
washstand pedestal

W: 580 D: 470 H: 840

Basin: B1\*  
Washstand: T22A CHR



### *TOWEL RAILS*

Add a towel rail to  
your basin.

580mm basin  
T2 CHR

#### **Optional Extra for T22A CHR**

We now offer an additional towel rack to add to your washstand.  
Please order the below:

T22A-S



**ONE, TWO, OR THREE TAP HOLE**



Select the brassware look you prefer with a choice of 1, 2 or 3 tap hole basins. Simply add 1TH, 2TH or 3TH to the end of your desired basin code. See page 152 to choose your corresponding brassware.

**OPT FOR A TALLER BASIN INSTALLATION**

Basin shapes	Size	Regal pedestal	Regal chrome washstand
Rectangular	580 x 470	P9	T22A CHR+T62



Regal pedestal



Regal chrome washstand



**SEMI-RECESSED & COUNTERTOP BASINS**



580mm semi-recessed basin  
W: 575 D: 470  
Basin: B12\*\*



540mm countertop basin  
W: 575 D: 470  
Basin: B13\*\*

\* Contemporary basins are available with one, two or three tap holes. To order the correct basin configuration simply replace '\*\*' with 1TH, 2TH or 3TH.  
\*\* Semi-recessed and countertop basins available as one or two tap holes

# NATURAL STONE BASINS

Select your basin shape



· *NEW* ·



Small roll top basin with stainless steel stand  
 W: 550 D: 470 H: 880  
 Basin: B7E\*  
 Washstand: B7ES

Medium roll top basin with stainless steel stand  
 W: 650 D: 470 H: 880  
 Basin: B8E\*  
 Washstand: B8ES

Large roll top basin with stainless steel stand  
 W: 750 D: 470 H: 880  
 Basin: B9E\*  
 Washstand: B9ES

Double roll top basin with stainless steel stand  
 W: 750 D: 470 H: 880  
 Basin: B9E\*  
 Washstand: B9ES

\* Natural Stone basins are supplied undrilled for your preferred choice of 1, 2 or 3 taphole. Tap holes are drilled by the installer in the required position and configuration



**Small roll top with up-stand**

W: 550 D: 470 H: 880

Basin: B7E UPS

This can be also paired with the small stainless steel stand, B7ES.

Designed to work with Riviera wall mounted basin mixers.

**Medium roll top with up-stand**

W: 650 D: 470 H: 880

Basin: B8E UPS

This can be also paired with the small stainless steel stand, B8ES.

Designed to work with Arcade wall mounted basin mixers.

· *NEW* ·

## GEORGIAN MARBLE BASINS

Select your basin shape



Georgian Marble  
650mm basin



650mm Georgian  
Marble basin shown  
with distressed  
aluminium washstand

W: 650 D: 575 H: 805

Basin: G1\*

Washstand: T38 ALU



650mm Georgian Marble  
basin shown with Black  
aluminium washstand

W: 650 D: 575 H: 805

Basin: G1\*

Washstand: T48 BLA



650mm Georgian Marble  
basin shown with White  
aluminium washstand

W: 650 D: 575 H: 805

Basin: G1\*

Washstand: T43 WHI





650mm Georgian Marble basin shown with distressed aluminium washstand with shelf

W: 650 D: 575 H: 805

Basin: G1\*  
Washstand: T38 ALU + G11

650mm Georgian Marble basin shown with Black aluminium washstand with shelf

W: 650 D: 575 H: 805

Basin: G1\*  
Washstand: T48 BLA + G11

650mm Georgian Marble basin shown with White aluminium washstand with shelf

W: 650 D: 575 H: 805

Basin: G1\*  
Washstand: T43 WHI + G11

650mm Georgian Marble basin shown with standard chrome washstand

W: 650 D: 575 H: 805

Basin: G1\*  
Washstand: T49A CHR

**OPT FOR A TALLER BASIN INSTALLATION**

Size	Regal chrome washstand
650 x 575	T49A CHR+T62



Regal chrome washstand

870mm

**ONE, TWO, OR THREE TAP HOLE**



Select the brassware look you prefer with a choice of 1, 2 or 3 tap hole basins. Simply add 1TH, 2TH or 3TH to the end of your desired basin code. See page 152 to choose your corresponding brassware.

**UPSTANDS**



Your Georgian marble basin comes with rear and side upstands so you can tailor to your preferred look.

\*Marble basins are available with no tap hole, 1 tap hole, 2 tap hole or 3 tap hole. To order the correct basin configuration simply replace '\*' with 0TH, 1TH, 2TH or 3TH. Marble upstands can be installed with rear and side upstands, rear upstand only or no upstand.

# CLOAKROOM BASINS

Select your basin shape

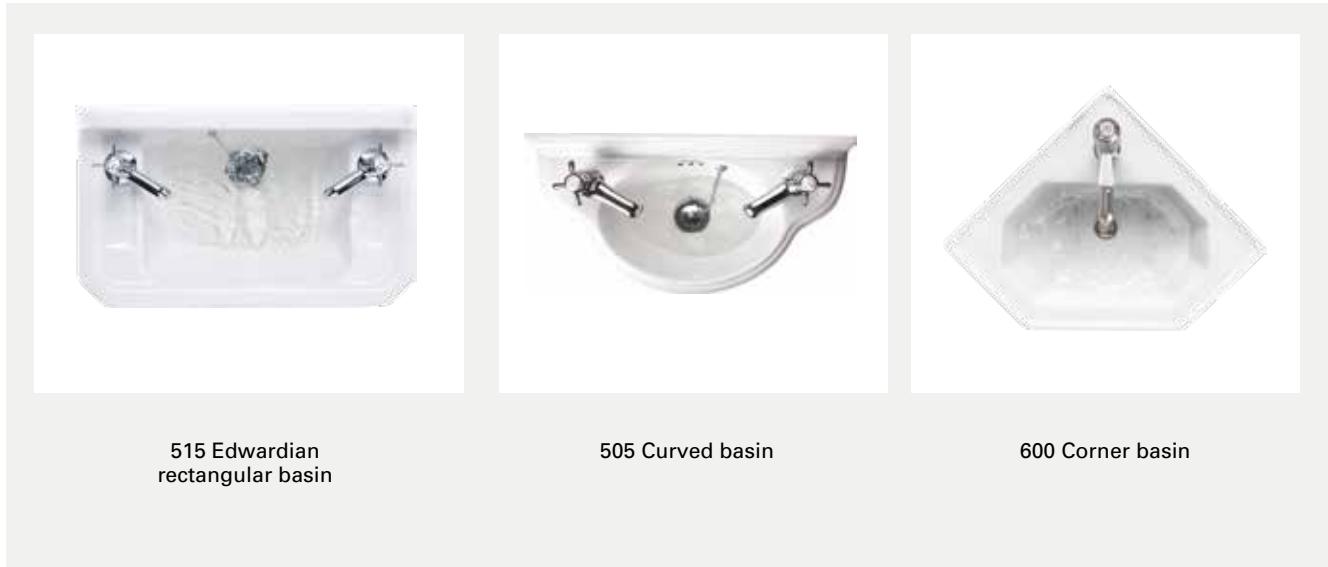

515 Edwardian rectangular basin

505 Curved basin

600 Corner basin



515 Edwardian rectangular basin with chrome washstand

W: 515 D: 308 H: 825

Basin: B8\*

Washstand: T21A CHR

515 Edwardian rectangular basin

W: 515 D: 308

Basin: B8\*

\*Edwardian & Curved Cloakroom basins are available with one tap hole on the right. To order this simply add 'R' to the product code.

505 Curved basin

W: 505 D: 255

Basin: P13\*

\*Edwardian & Curved Cloakroom basins are available with one tap hole on the right. To order this simply add 'R' to the product code.

600 Corner basin

W: 600 D: 450

Basin: B10



**OPT FOR A TALLER  
BASIN INSTALLATION**

Basin shapes	Size	Regal chrome washstand
Edwardian Rectangular	515 x 308	T21A CHR+T62



Regal chrome washstand



885mm

**TOWEL RAILS**



Add a towel rail to your Edwardian basin.

T6 CHR





## ARCADE BASINS



**500mm cloakroom  
basin with overflow**

W: 500 D: 400

Basin: ARC500\*



**600mm basin with  
overflow & pedestal**

W: 605 D: 525 H: 840

Basin: ARC600\*  
Pedestal: ARC1



**900mm basin with  
overflow & pedestal**

W: 905 D: 550 H: 840

Basin: ARC900\*  
Pedestal: ARC1

Compatible wastes: ARCW19, ARCW14 (Add NKL for Nickel, CHR for Chrome). If a chrome overflow ring is required, A68 CHR can be ordered free of charge from your dealer. ARC500 basin is available with one or two tap holes. ARC600 and ARC900 basins are available with no, one, two or three tapholes. To order the correct basin configuration simply replace '\*' with 0TH, 1TH, 2TH or 3TH.



**600mm basin with overflow  
and ceramic console legs**

W: 605 D: 525 H: 840

Basin: ARC600\*  
Legs: ARC2



**900mm basin with overflow  
and ceramic console legs**

W: 905 D: 550 H: 840

Basin: ARC900\*  
Legs: ARC2



**1200mm basin with overflow  
and ceramic console legs**

W: 1215 D: 560 H: 840

Basin: ARC1200\*  
Legs: ARC2

Compatible wastes: ARCW18, ARCW19, ARCW14 (Add NKL for Nickel, CHR for Chrome). If a chrome overflow ring is required, A68 CHR can be ordered free of charge from your dealer. ARC600, ARC900 and ARC1200 basins are available with no, one, two or three tap holes. To order the correct basin configuration simply replace '\*\*' with 0TH, 1TH, 2TH or 3TH.



*NICKEL STAND*



*CHROME STAND*

Basin stands available in both Nickel (left) and Chrome (right)

## NICKEL & CHROME BASIN STANDS



600mm basin with overflow,  
stand & glass shelf

W: 605 D: 525 H: 840

Basin: ARC600\*  
Stand: ARC22 NKL



900mm basin with overflow,  
stand & glass shelf

W: 905 D: 550 H: 840

Basin: ARC900\*  
Stand: ARC23 NKL



1200mm double basin with double  
overflow, stand & glass shelf

W: 1215 D: 550 H: 840

Basin: ARC1200\*  
Stand: ARC24 NKL

Basin stands are constructed from stainless steel and have a nickel plate finish. Compatible wastes: ARCW18 NKL, ARCW19 NKL, ARCW14 NKL. If a chrome overflow ring is required, A68 CHR can be ordered free of charge from your dealer. ARC600, ARC900 and ARC1200 basins are available with no, one, two or three tap holes. To order the correct basin configuration simply replace '\*\*' with 0TH, 1TH, 2TH OT 3TH.



600mm basin with overflow,  
stand & glass shelf

W: 605 D: 525 H: 840

Basin: ARC600\*  
Stand: ARC22 CHR



900mm basin with overflow,  
stand & glass shelf

W: 905 D: 550 H: 840

Basin: ARC900\*  
Stand: ARC23 CHR



1200mm double basin with double  
overflow, stand & glass shelf

W: 605 D: 525 H: 840

Basin: ARC1200\*  
Stand: ARC24 CHR

Basin stands are constructed from stainless steel and have a chrome plate finish. Compatible wastes: ARCW18 CHR, ARCW19 CHR, ARCW14 CHR. If a chrome overflow ring is required, A68 CHR can be ordered free of charge from your dealer. ARC600, ARC900 and ARC1200 basins are available with no, one, two or three tap holes. To order the correct basin configuration simply replace '\*\*' with 0TH, 1TH, 2TH OT 3TH.

The Arcade bicycle is inspiring and eye-catching which adds a unique character to your bathroom. Available with optional oak shelf.





## *ARCADE PASHLEY BICYCLE*



### **Pashley bicycle**

Bicycle

W: 1794 D: 600 H: 880

Code: BICY1

Basin

W: 840 D: 550

Code: ARC600

Oak shelf code: BICYSHELF (Optional)

## JET CLASSIC RECTANGULAR BASINS



Jet Classic rectangular basin 650mm 1TH and Jet Classic pedestal

W: 650 D: 575 H: 860

Basin: B15 2TH JET  
Pedestal: PG JET

Jet Classic rectangular basin 650mm 1TH and washstand

W: 650 D: 575 H: 860

Basin: B15 2TH JET  
Washstand: T49A CHR

Jet Classic rectangular basin 650mm 1TH and Black aluminium washstand

W: 650 D: 575 H: 860

Basin: B15 1TH JET  
Washstand: T48 BLA

Jet 580mm semi-recessed basin

W: 580 D: 470

Basin: B12 1TH JET



B15 basins are available as 1, 2 or 3 tap hole versions.

B12 basins are available as 1 or 2 tap hole versions.

B4 basins are available as 1, 2 or 3 tap hole versions.

B19 basins are available as a 3 tap hole only.

B8 basins are available as a 2 tap hole only.

Simply change the code to 1TH, 2TH or 3TH for your desired option.

Brassware not included.

# JET EDWARDIAN BASINS



Jet Edwardian basin  
560mm 3TH and Jet  
Classic pedestal  
W: 560 D: 470 H: 840  
Basin: B4 3TH JET  
Pedestal: P1 JET



Jet Edwardian basin  
560mm 3TH and  
washstand  
W: 560 D: 470 H: 845  
Basin: B4 3TH JET  
Pedestal: T22A CHR



Jet Edwardian basin  
1200mm 3TH and Jet  
Classic pedestal  
W: 1200 D: 510 H: 840  
Basin: B19 3TH JET  
Pedestal: P6 JET



Jet Edwardian basin  
1200mm 3TH and  
washstand  
W: 1200 D: 510 H: 840  
Basin: B19 3TH JET  
Pedestal: T51 CHR



Jet Edwardian cloakroom  
basin 510mm 2TH  
W: 515 D: 308  
Basin: B8 2TH JET



Jet Edwardian cloakroom  
basin 510mm 2TH and  
washstand  
W: 515 D: 308 H: 825  
Basin: B8 2TH JET  
Washstand: T21A CHR



## MEDICI CLASSIC RECTANGULAR BASINS



Medici Classic rectangular basin 650mm 1TH and Medici Classic pedestal

W: 650 D: 575 H: 860

Basin: B15 1TH M  
Pedestal: P6 M



Medici Classic rectangular basin 650mm 1TH and washstand

W: 650 D: 575 H: 860

Basin: B15 1TH M  
Washstand: T49A CHR



Medici Classic rectangular basin 650mm 1TH and Black aluminium washstand

W: 650 D: 575 H: 860

Basin: B15 1TH M  
Washstand: T48 BLA

B15 and B4 basins are available as 1, 2 or 3 tap hole versions.

B8 basins are available as 2TH only and B19 as 1TH only.

Simply change the code to 1TH, 2TH or 3TH for your desired option.

Brassware not included.





## MEDICI EDWARDIAN BASINS



Medici Edwardian basin  
560mm 1TH and Medici  
Classic pedestal

W: 560 D: 470 H: 840

Basin: B4 1TH M  
Pedestal: P1 M

Medici Edwardian  
basin 560mm 1TH and  
washstand

W: 560 D: 470 H: 840

Basin: B4 1TH M  
Pedestal: T22A CHR

Medici Edwardian basin  
1200mm 1TH and Medici  
Classic pedestal

W: 1200 D: 510 H: 840

Basin: B19 1TH M  
Pedestal: P6 M

Medici Edwardian  
basin 1200mm 1TH and  
washstand

W: 1200 D: 510 H: 840

Basin: B19 1TH M  
Pedestal: T51 CHR



Medici Edwardian  
cloakroom basin 510mm  
2TH

W: 515 D: 308

Basin: B8 2TH M

Medici Edwardian  
cloakroom basin 510mm  
2TH and washstand

W: 515 D: 308 H: 825

Basin: B8 2TH M  
Washstand: T21A CHR





# WCs

The widest range of traditional WC options to suit your installation and match the exact look you want. Available in White, Jet and Medici, now with alternative finish options of Gold and Nickel flush pipes.



Wall-hung    Back-to-wall    Close-coupled    Low level    Medium level    High level



# WC OPTIONS

## REGAL WCs

At Burlington we've created a range that's taller than average sanitaryware. Regal WC pans are 60mm higher than the standard option.



At 480mm high the taller WC pan ensures the knee angle remains at approximately 90 degrees whilst in use, which is the correct seating position. The taller WC provides a more comfortable use for taller people and the elderly whilst ensuring your WC is functional as well as beautiful too.

## RIMLESS WCs



Burlington bathrooms are the first traditional bathroom provider to introduce rimless technology to traditionally styled WCs.

With the removal of the standard WC rim, this WC choice is exceptionally easy to keep clean. Its powerful flush covers the entire ceramic bowl, making it the most hygienic option.

Available with both standard and slimline cisterns for standard height close-coupled, back-to-wall and medium level WCs.



Hygienic



Easy to clean



Powerful flush



Economic



**nanoGLAZE**  
ceramic that stays cleaner

All WCs have a unique stay-clean NANO Glaze coating, creating an ultra-smooth surface, six times smoother than standard ceramic.



All Burlington close-coupled WCs are supplied with dual flush WRAS fittings.



All Burlington WC fittings are factory set at 3L and 6L flush. They can be adjusted on site to flush at 2 1/2L and 4 1/2L.



**Lever or push button cistern**

Available with all Burlington Close-coupled, Low and Mid level WCs. Choose between the classic ceramic flush lever or the more contemporary flush front button.



**Lever**  
52cm Cistern (C1)  
44cm Cistern (C3)  
52cm Rear Entry Cistern (C30)



**Push Button**  
52cm Cistern (C2)  
44cm Cistern (C4)

**Feature levers**

Our feature cistern levers in Black or New Walnut are the perfect finishing touches and work beautifully with our other feature options such as WC seats, brassware and accessories.



**Black Lever**  
To add a Black Lever please add BLA to end of the code.



**Walnut Lever**  
To add a Walnut Lever please add WAL to end of the code.



**Gold Lever**  
To add a Gold Lever please order a SP390 GOLD.



**Nickel Lever**  
To add a Nickel Lever please order a SP8 NKL

## CLOSE-COUPLED WCs



**Standard CC WC with 520 lever cistern**  
 W: 520 D: 730 H: 780  
 Pan: P5  
 Lever Cistern: C1  
 Button Cistern: C2



**Standard CC WC with 440 lever cistern**  
 W: 440 D: 730 H: 780  
 Pan: P5  
 Lever Cistern: C3  
 Button Cistern: C4



**Regal Standard CC WC with 520 lever cistern**  
 W: 520 D: 730 H: 780  
 Pan: P12  
 Lever Cistern: C1  
 Button Cistern: C2



**Regal Standard CC WC with 440 lever cistern**  
 W: 440 D: 730 H: 780  
 Pan: P12  
 Lever Cistern: C3  
 Button Cistern: C4:



**Rimless Standard CC WC with 520 lever cistern**  
 W: 520 D: 730 H: 780  
 Pan: P20  
 Lever Cistern: C1  
 Button Cistern: C2



**Rimless Standard CC WC with 440 lever cistern**  
 W: 440 D: 730 H: 780  
 Pan: P20  
 Lever Cistern: C3  
 Button Cistern: C4



**S Trap Standard CC WC with 520 lever cistern**  
 W: 520 D: 730 H: 780  
 Pan: P18  
 Lever Cistern: C1  
 Button Cistern: C2



**S Trap Standard CC WC with 440 lever cistern**  
 W: 440 D: 730 H: 780  
 Pan: P18  
 Lever Cistern: C3  
 Button Cistern: C4



### **FEATURE LEVERS**

Our feature cistern levers in Black, Walnut or NEW Gold and Nickel are the perfect finishing touches and work beautifully with our other feature options such as WC seats, brassware and accessories.



To add a Black Lever please add BLA to end of the code.



To add a Walnut Lever please add WAL to end of the code.



To add a Gold Lever please order a SP390 GOLD.



To add a Nickel Lever please order a SP8 NKL.

### **WC REAR ENTRY OPTIONS**

Burlington cisterns are available with either bottom or back entry filling for flexible installation.

If you need to fill your cistern from the back, please order one of the below options.

#### **Back entry 520mm lever cistern**

C24

#### **Back entry 520mm deep lever cistern**

(This deep cistern increases the distance from pan outlet to the wall by 20mm)

C30

· NEW ·

## LOW LEVEL WCs

**GOLD AND NICKEL FLUSH PIPES NOW AVAILABLE FOR LOW LEVEL**



Gold Flush Pipe  
T31 GOLD



Nickel Flush Pipe  
T31 NKL



Standard low level WC  
with 520 lever cistern

W: 520 D: 740 H: 1075

Pan: P2  
Lever Cistern: C1  
Button Cistern: C2  
Flush Pipe: T31 CHR



Standard low level WC  
with 440 lever cistern

W: 440 D: 740 H: 1075

Pan: P2  
Lever Cistern: C3  
Button Cistern: C4  
Flush Pipe: T31 CHR



Regal low level WC  
with 520 lever cistern

W: 520 D: 740 H: 1075

Pan: P16  
Lever Cistern: C1  
Button Cistern: C2  
Flush Pipe: T31 CHR



Regal low level WC  
with 440 lever cistern

W: 440 D: 740 H: 1075

Pan: P16  
Lever Cistern: C3  
Button Cistern: C4  
Flush Pipe: T31 CHR



S trap low level WC  
with 520 lever cistern

W: 520 D: 740 H: 1075

Pan: P19  
Lever Cistern: C1  
Button Cistern: C2  
Flush Pipe: T31 CHR



S trap low level WC  
with 440 lever cistern

W: 440 D: 740 H: 1075

Pan: P19  
Lever Cistern: C3  
Button Cistern: C4  
Flush Pipe: T31 CHR

### WC REAR ENTRY OPTIONS

Burlington cisterns are available with either bottom or back entry filling for flexible installation.

If you need to fill your cistern from the back, please order one of the below options.

#### Back entry 520mm lever cistern

C24

#### Back entry 520mm deep lever cistern

(This deep cistern increases the distance from pan outlet to the wall by 20mm)

C30



## MEDIUM LEVEL WCs



**Standard medium level WC with 520 lever cistern**

W: 520 D: 740 H: 1425

Pan: P5  
Lever Cistern: C1  
Button Cistern: C2  
Flush Pipe: T33 CHR



**Standard medium level WC with 440 lever cistern**

W: 440 D: 740 H: 1425

Pan: P5  
Lever Cistern: C3  
Button Cistern: C4  
Flush Pipe: T33 CHR

### FEATURE LEVERS

Our feature cistern levers in Black, Walnut or NEW Gold and Nickel are the perfect finishing touches and work beautifully with our other feature options such as WC seats, brassware and accessories.



To add a Black Lever please add BLA to end of the code.



To add a Walnut Lever please add WAL to end of the code.



To add a Gold Lever please order a SP390 GOLD.



To add a Nickel Lever please order a SP8 NKL.



**Regal medium level WC with 520 lever cistern**

W: 520 D: 740 H: 1425

Pan: P12  
Lever Cistern: C1  
Button Cistern: C2  
Flush Pipe: T33 CHR



**Regal medium level WC with 440 lever cistern**

W: 440 D: 740 H: 1425

Pan: P12  
Lever Cistern: C3  
Button Cistern: C4  
Flush Pipe: T33 CHR





***WC REAR  
ENTRY OPTIONS***

Burlington cisterns are available with either bottom or back entry filling for flexible installation.

If you need to fill your cistern from the back, please order one of the below options.

**Back entry 520mm  
lever cistern**

C24

**Back entry 520mm deep  
lever cistern**

(This deep cistern increases the distance from pan outlet to the wall by 20mm)

C30

## MEDIUM LEVEL WCs



Rimless medium level WC with 520 lever cistern

W: 520 D: 740 H: 1425

Pan: P20  
Lever Cistern: C1  
Button Cistern: C2  
Flush Pipe: T33 CHR

Rimless medium level WC with 440 lever cistern

W: 440 D: 740 H: 1425

Pan: P20  
Lever Cistern: C3  
Button Cistern: C4  
Flush Pipe: T33 CHR

S trap medium level WC with 520 lever cistern

W: 520 D: 740 H: 1425

Pan: P18  
Lever Cistern: C1  
Button Cistern: C2  
Flush Pipe: T33 CHR

S trap medium level WC with 440 lever cistern

W: 440 D: 740 H: 1425

Pan: P18  
Lever Cistern: C3  
Button Cistern: C4  
Flush Pipe: T33 CHR

### CISTERN OPTIONS

A diverse range of WC options to suit your specific installation and desired aesthetic. Our feature cistern levers in Black, Walnut or New Gold and Nickel are the perfect finishing touches and work beautifully with our other feature options such as WC seats, brassware and accessories.



**Lever**  
52cm Cistern (C1)  
44cm Cistern (C3)  
52cm Rear Entry Cistern (C30)



**Push Button**  
52cm Cistern (C2)  
44cm Cistern (C4)



**Black Lever**  
To add a Black Lever please add BLA to end of the code.



**Walnut Lever**  
To add a Walnut Lever please add WAL to end of the code.



**Gold Lever**  
To add a Gold Lever please order a SP390 GOLD.



**Nickel Lever**  
To add a Nickel Lever please order a SP8 NKL.

## HIGH LEVEL WCs

### FEATURE PULL LEVERS



To add a Black Pull Lever (C28S Cistern only) please add BLA to end of the code.



To add a Walnut Pull Lever (C28S Cistern only) please add WAL to end of the code.



Standard high level WC with dual flush ceramic cistern

W: 520 D: 670 H: 2300-2380

Pan: P2  
Lever Cistern: C5  
Flush Pipe: T30 CHR



Standard high level WC with single flush ceramic cistern

W: 520 D: 670 H: 2300-2380

Pan: P2  
Lever Cistern: C28S  
Flush Pipe: T30 CHR



Standard high level WC with dual flush aluminium cistern

W: 430 D: 670 H: 2300-2380

Pan: P2  
Lever Cistern: T58 ALU  
Flush Pipe: T30 CHR



Standard high level WC with dual flush black aluminium cistern

W: 430 D: 670 H: 2300-2380

Pan: P2  
Lever Cistern: T60 BLA  
Flush Pipe: T30 CHR



Standard high level WC with dual flush white aluminium cistern

W: 430 D: 670 H: 2300-2380

Pan: P2  
Lever Cistern: T59 WHI  
Flush Pipe: T30 CHR



Regal high level WC with dual flush ceramic cistern

W: 520 D: 670 H: 2300-2380

Pan: P16  
Lever Cistern: C5  
Flush Pipe: T30 CHR



Regal high level WC with single flush ceramic cistern

W: 520 D: 670 H: 2300-2380

Pan: P16  
Lever Cistern: C28S  
Flush Pipe: T30 CHR



Regal high level WC with dual flush aluminium cistern

W: 430 D: 670 H: 2300-2380

Pan: P16  
Lever Cistern: T58 ALU  
Flush Pipe: T30 CHR



· **NEW** ·

**GOLD AND NICKEL FLUSH PIPES & LEVERS NOW AVAILABLE FOR HIGH LEVEL**



Gold Flush Pipe  
T30 GOLD

Gold Dual Flush  
Lever for a C5  
SP391 GOLD

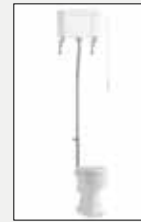

Nickel Flush Pipe  
T30 NKL

Nickel Dual Flush  
Lever for a C5  
SP391 NKL



Regal high level WC with dual flush black aluminium cistern

W: 430 D: 670 H: 2300-2380

Pan: P16  
Lever Cistern: T60 BLA  
Flush Pipe: T30 CHR



Regal high level WC with dual flush white aluminium cistern

W: 430 D: 670 H: 2300-2380

Pan: P16  
Lever Cistern: T59 WHI  
Flush Pipe: T30 CHR



S trap high level WC with dual flush ceramic cistern

W: 520 D: 670 H: 2300-2380

Pan: P19  
Lever Cistern: C5  
Flush Pipe: T30 CHR



S trap high level WC with single flush ceramic cistern

W: 520 D: 670 H: 2300-2380

Pan: P19  
Lever Cistern: C28S  
Flush Pipe: T30 CHR



S trap high level WC with dual flush aluminium cistern

W: 430 D: 670 H: 2300-2380

Pan: P19  
Lever Cistern: T58 ALU  
Flush Pipe: T30 CHR



S trap high level WC with dual flush black aluminium cistern

W: 430 D: 670 H: 2300-2380

Pan: P19  
Lever Cistern: T60 BLA  
Flush Pipe: T30 CHR



S trap high level WC with dual flush white aluminium cistern

W: 430 D: 670 H: 2300-2380

Pan: P19  
Lever Cistern: T59 WHI  
Flush Pipe: T30 CHR



High-level pan with high level cistern and high-level angled flush pipe

Angled flush pipe can be ordered as an extra on all high level WCs

W: 905 D: 700 H: 2725

Pan: P2  
Lever Cistern: C5  
Flush Pipe: T34 CHR

## CHROME CISTERNS

For an additional lustrous finish, select the chrome cistern for low, medium and high level WCs. These work beautifully when paired with basins on chrome washstands, baths with chrome feet or the all new Balthazar bath with its stunning stainless steel finish. See page 36 or 134.



Standard low level WC  
with 440 chrome cistern  
W: 440 D: 740 H: 960-1130

Pan: P2  
Lever Cistern: T71 CHR  
Flush Pipe: T31 CHR

Optional brackets T32 CHR see page 194



Standard medium level WC  
with 440 chrome cistern  
W: 440 D: 730 H: 1340-1425

Pan: P5  
Lever Cistern: T71 CHR  
Flush Pipe: T33 CHR

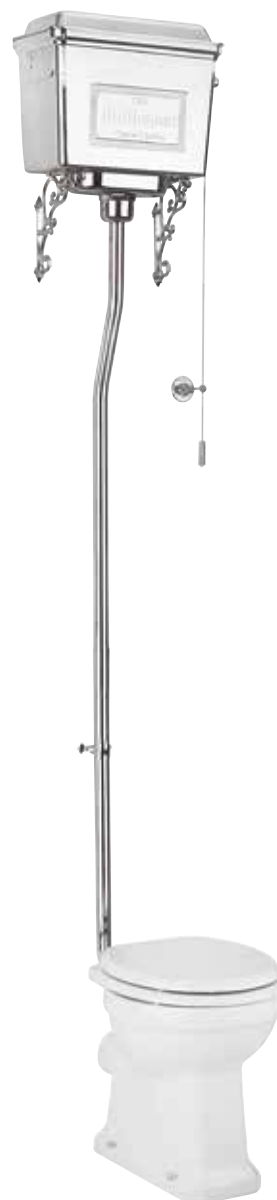

Standard high level WC with  
440 chrome cistern  
W: 440 D: 670 H: 2320-2400

Pan: P2  
Lever Cistern: T70 CHR  
Flush Pipe: T30 CHR

## BACK-TO-WALL WCs



**Rimless Back-to-wall**  
 W: 370 D: 480 H: 420  
 Pan: P21  
 With a concealed cistern  
 Code: F6CC



**Back-to-wall**  
 W: 360 D: 475 H: 425  
 Pan: P14  
 With a concealed cistern  
 Code: F6CC



**Regal back-to-wall**  
 W: 370 D: 480 H: 480  
 Pan: P15  
 With a concealed cistern  
 Code: F6CC



**Wall-hung**  
 W: 355 D: 500  
 Pan: P10  
 Pair the wall-hung WC  
 with a concealed cistern  
 Code: F6CC

## BIDETS



**Wall-hung**  
 W: 370 D: 500  
 Bidet: P11



**Floor-standing**  
 W: 400 D: 570 H: 400  
 Bidet: P4

## WC ACCESSORIES



**Ceramic traps for  
 converting P trap  
 to S trap**  
 Trap: C26



**Straight ceramic trap**  
 Trap: C29

**nanoGLAZE**  
*ceramic that stays cleaner*

**A cleaner toilet, by design and with NANO Glaze**

We believe that the toilet bowl should still remain as clean as possible even with reduced flushing water and therefore engineer our toilet bowls to maintain the correct water area as previous British Standards and by coating the toilet bowl with NANO Glaze to make them exceptionally easy to keep clean.

# SEATS

Our choice of seats includes standard oak or mahogany, white carbamide (also available in a soft-close option), or soft close seats in a range of colours to match your furniture choice, black to pair with black cistern levers and accessories, beech for a classic look or walnut solid wood to match with our New walnut trims. Pair your high level WC with our throne seats with ornate brackets.



Soft-close sand seat  
(excluding handles)

Seat: S43



Soft-close dark olive seat  
(excluding handles)

Seat: S44



Soft-close matt white seat  
(excluding handles)

Seat: S45



Soft-close classic grey seat  
(excluding handles)

Seat: S46



· NEW ·

Soft-close blue seat  
(excluding handles)

Seat: S99



Soft-close matt black seat  
(excluding handles)

Matt: S48  
Gloss: S40



Soft-close Medici seat  
(excluding handles)

Code: S50



Soft-close walnut  
solid wood seat  
(excluding handles)

Seat: S47



Soft-close beech  
solid wood seat  
(excluding handles)

Seat: S51



Standard oak seat  
(excluding handles)

Seat: S11

Soft-close  
(excluding handles)

Seat: S16



Standard gloss mahogany  
seat (excluding handles)

Seat: S12

Soft-close  
(excluding handles)

Seat: S17



Standard white carbamide  
seat (not suitable for  
handles)

Seat: S13

Soft-close  
(not suitable for handles)

Seat: S18



Walnut throne seat for  
high level WCs  
(not suitable for handles)

Seat: S52



Beech throne seat  
for high level WCs  
(not suitable for handles)

Seat: S53



All seats are supplied  
without handles. To add  
seat handles use code

Chrome: A51 CHR  
Nickel: ARCA51  
Gold: A51

To order Gold WC pan  
fixings with Gold cover caps  
please use code

Gold: SP387

All seats come with chrome  
hinges. To order Nickel or  
Gold hinges use code

Nickel: A75 NKL  
Gold: SP813 GOLD



*ARCADE WCs*

Full back-to-wall  
close-coupled pan  
and dual flush cistern

W: 500 D: 670 H: 885

Pan: ARC4\*

Lever Cistern: ARC5



Back-to-wall pan

W: 365 D: 520 H: 400

Pan: ARC6\*



## JET WCs



Jet high level WC with  
Black single flush cistern  
and flush pipe kit

W: 520 D: 670 H: 2300-2380

Pan: P2 JET  
Cistern: C28S JET  
Flush pipe: T30 CHR



Jet medium level WC  
with 520mm Black lever  
cistern and flush pipe kit

W: 520 D: 740 H: 1425

Pan: P5 JET  
Cistern: C1 JET  
Flush pipe: T33 CHR



Jet close-coupled WC  
with 520mm Black lever  
cistern

W: 520 D: 730 H: 780

Pan: P5 JET  
Cistern: C1 JET



Jet close-coupled WC  
with 520mm Black lever  
cistern

W: 520 D: 730 H: 780

Pan: P5 JET  
Cistern: C1 JET

## JET WC ACCESSORIES



Jet back to wall WC  
W: 370 D: 480 H: 420

Pan: P14 JET

*With a concealed cistern and  
Black lever: F6CC BLA*



Jet gloss soft-close WC  
seat

W: 530 D: 730 H: 780

Code: S40

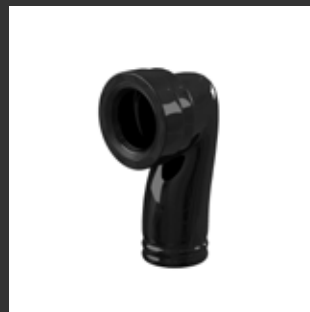

Jet ceramic traps for  
converting P trap  
to S trap

Trap: C26 JET



Jet straight ceramic  
trap

Trap: C29 JET









## MEDICI WCs



Medici medium level  
WC with 520mm lever  
cistern and flush pipe kit

W: 520 D: 740 H: 1425

Pan: P5 M

Cistern: C1 M

Flush pipe: T33 CHR



Medici close-coupled  
WC with 520mm lever  
cistern

W: 530 D: 730 H: 780

Pan: P5 M

Cistern: C1 M



Medici soft-close WC  
seat

W: 530 D: 730 H: 780

Code: S50

## MEDICI WC ACCESSORIES



Medici ceramic traps  
for converting P trap  
to S trap

Trap: C26 M



Medici straight  
ceramic trap

Trap: C29 M

**nanoGLAZE**  
*ceramic that stays cleaner*

A cleaner toilet, by design and with NANO Glaze

We believe that the toilet bowl should still remain as clean as possible even with reduced flushing water and therefore engineer our toilet bowls to maintain the correct water area as previous British Standards and by coating the toilet bowl with NANO Glaze to make them exceptionally easy to keep clean.

# *FURNITURE*

A range of beautifully traditional furniture solutions to add classic style and sophisticated British elegance to your bathroom. Choose from freestanding in either square or curved design, cloakroom or fully fitted options to create the most functional space to suit your individual needs.

Now available in a striking Blue finish, across selected models.





## FURNITURE WITH INTELLIGENT DESIGN

Our furniture solutions are made from the finest materials and offer innovative features and smart details that not only make them suitable for the bathroom environment but built to last with a 10 year guarantee.



### FULLY FITTED FURNITURE

Unlike conventional fitted furniture, our units offer full floor to height storage providing increased space for all your bathroom cosmetics and accessories.

### CHOICE OF COLOUR

Four stunning and serene colourways across our entire range which can be carried through the bath panels and WC seats for a consistent and seamless look.

### MINERVA BASINS AND WORKTOPS

Minerva basins fit perfectly with your chosen furniture unit. Should you opt for a fitted furniture look, a Minerva worktop can be chosen to fit the length of your furniture units.

### 5 LAYERS OF PAINT

Each of our furniture pieces are prepared with 5 layers of primer featuring UV stabilisation to minimise colour fading from exposure to sunlight. The painted top coat is then applied for a glorious depth of colour.



### ROUTINE CLEANING

Minerva® does not require any specialist cleaning regimes, most dirt and light residue will easily wipe off with a damp cloth and soapy water. The work surface should then be rinsed with clean water and wiped dry. Persistent marks can be removed by using a mild abrasive cleaner, but harsh scouring powders should be avoided.



### STAINING

Minerva®, unlike marble and granite, is not porous and will resist most household chemicals including alcohol and cosmetics, however, some chemicals and strong dyes can cause damage and discolouration. If spillage occurs, wipe off immediately and rinse the area thoroughly.



### TAP HOLES

Minerva® worktops are supplied with an integrated bowl with overflow, and no tap holes. Tap holes are drilled by the installer in the required position and configuration. A template is provided with the Minerva® tops indicating tap hole positions and sizes.



### MINOR SCRATCHING

Scratches to the work surface will be more evident on darker colours. Any minor scratches can be removed using a woven abrasive pad and other items in the care kit.



### MINERVA® CARE KIT

To restore your Minerva® work top to its original best use the Care Kit to buff out all tiny scratches and scuffs. The kit contains all the sanding / buffing materials and liquids required.



### CRAFTED SPECIFICALLY FOR BATHROOMS

The plinths of the freestanding furniture are crafted from a waterproof high density material - providing extra protection and giving peace of mind that wet floors will not lead to damage.



### DIMENSIONS & TECHNICAL DRAWINGS

Dimensional drawings and technical details are shown at [burlingtonbathrooms.com/furniture](http://burlingtonbathrooms.com/furniture)





## MINERVA WORKTOPS

Minerva worktops offer superior strength with a beautiful finish. Available from stock in either pristine White, elegant Carrara White or opulent Black Granite. Why not choose from our other 11 unique decor options, available to order with longer custom delivery times for the ultimate personalised look. Please ask your retailer for details on the price of the 11 additional finishes.



White



Carrara White



Black Granite

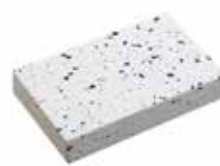

Ice Blue



Desert Rock



Fossil



Peak Stone



Nimbus Grey



Amazonia Brown



Ice Crystal



Copper Fleck



Sparkling White



Caramel Crunch



Grey Crystal



Minerva® care kit

Code: BCARE



Minerva® Joint Kit

White: MVWH  
Carrara White: MVBG  
Carrara Black: MVCA

## *PAIN* YOUR OWN

Should you wish, our Matt White furniture is supplied ready for you to paint, so you can transform your entire bathroom into your individual colour scheme. We've chosen some Farrow & Ball colours as suggestions displayed below. We recommend using a water based primer before an egg shell paint finish for the best effect.



Pelt



Red Earth



Brassica



Vert De Terre



Cook's Blue



Cinder Rose





# FREESTANDING CLOAKROOM VANITY UNIT

AVAILABLE IN



**Edwardian cloakroom basin & freestanding rectangular cloakroom vanity unit**

W: 510 D: 310 H: 760

- Matt White: FC11W + B8
- Sand: FC11S + B8
- Dark Olive: FC11O + B8
- Classic Grey: FC11G + B8
- Blue: FC11B + B8



**Edwardian 560mm basin & freestanding rectangular cloakroom vanity unit**

W: 560 D: 470 H: 760

- Matt White: FC12W + B4
- Sand: FC12S + B4
- Dark Olive: FC12O + B4
- Classic Grey: FC12G + B4
- Blue: FC12B + B4



**Classic 510mm basin & freestanding 500mm square cloakroom vanity unit**

W: 510 D: 500 H: 760

- Matt White: FC8W + B20
- Sand: FC8S + B20
- Dark Olive: FC8O + B20
- Classic Grey: FC8G + B20
- Blue: FC8B + B20

AVAILABLE IN



**Corner quattrocass basin & freestanding corner cloakroom vanity unit**

Right hand only. Handles are supplied fitted.

W: 445 D: 445 H: 785

- Matt White: FC7W + FC7BB
- Classic Grey: FC7G + FC7BB

## CLOAKROOM BASINS

Our cloakroom furniture units are available with corresponding basins in Edwardian or Classic cloakroom styles. See page 82 for the Edwardian cloakroom basin or page 65 for the Classic 510mm basin.



**515mm Edwardian rectangular basin**

W: 515 D: 320

Basin: B8



**560mm Edwardian basin**

W: 560 D: 470

Basin: B4



**510mm Classic square basin**

W: 510 D: 580

Basin: B20

Chrome handles included with the furniture. To purchase alternative finishes please use the codes below:

Nickel: A56 NKL

Gold: A56 GOLD

# 650 FREESTANDING UNIT

AVAILABLE IN



Freestanding 650 vanity unit with doors & Classic 650 basin for standard waste & overflow

W: 670 D: 580 H: 930

Matt White: FF8W + B15  
 Sand: FF8S + B15  
 Dark Olive: FF8O + B15  
 Classic Grey: FF8G + B15  
 Blue: FF8B + B15



Freestanding 650 vanity unit with doors & Classic 650 basin for integrated waste & overflow

W: 670 D: 580 H: 930

Matt White: FF8W + B14  
 Sand: FF8S + B14  
 Dark Olive: FF8O + B14  
 Classic Grey: FF8G + B14  
 Blue: FF8B + B14



Freestanding 650 vanity unit with doors & Minerva® White with vanity bowl

W: 670 D: 580 H: 850-930

Matt White: FF8W + BW66  
 Sand: FF8S + BW66  
 Dark Olive: FF8O + BW66  
 Classic Grey: FF8G + BW66  
 Blue: FF8B + BW66



Freestanding 650 vanity unit with doors & Minerva® Carrara basin White vanity bowl

W: 670 D: 580 H: 850-930

Matt White: FF8W + BC66  
 Sand: FF8S + BC66  
 Dark Olive: FF8O + BC66  
 Classic Grey: FF8G + BC66  
 Blue: FF8B + BC66



Freestanding 650 vanity unit with doors & Minerva® Black Granite with vanity bowl

W: 670 D: 580 H: 850-930

Matt White: FF8W + BB66  
 Sand: FF8S + BB66  
 Dark Olive: FF8O + BB66  
 Classic Grey: FF8G + BB66  
 Blue: FF8B + BB66

## SOFT-CLOSE DOORS & DRAWERS

All of our units feature soft-close doors and drawers with wide opening spaces for maximum capacity. Add internal lighting to illuminate your vanity unit when movement is detected.



Chrome handles included with the furniture. To purchase alternative finishes please use the codes below:

Nickel: A56 NKL  
 Gold: A56 GOLD

# 650 FREESTANDING UNIT

AVAILABLE IN



Freestanding 650 vanity unit with drawers & Classic 650 basin for standard waste & overflow

W: 670 D: 580 H: 930

Matt White: FF9W + B15  
Classic Grey: FF9G + B15



Freestanding 650 vanity unit with drawers & Classic 650 basin for integrated waste & overflow

W: 670 D: 580 H: 930

Matt White: FF9W + B14  
Classic Grey: FF9G + B14



Freestanding 650 vanity unit with drawers & Minerva® White with vanity bowl

W: 670 D: 580 H: 850-930

Matt White: FF9W + BW66  
Classic Grey: FF9G + BW66



Freestanding 650 vanity unit with drawers & Minerva® Carrara basin White vanity bowl

W: 670 D: 580 H: 850-930

Matt White: FF9W + BC66  
Classic Grey: FF9G + BC66



Freestanding 650 vanity unit with drawers & Minerva® Black Granite with vanity bowl

W: 670 D: 580 H: 850-930

Matt White: FF9W + BB66  
Classic Grey: FF9G + BB66

## MINERVA TAP HOLES



Minerva basins are supplied with an integrated bowl with overflow and no tap holes. Tap holes are drilled by the installer in the required position and configuration. A template is provided with the Minerva tops indicating tap hole positions and size.



Chrome handles included with the furniture. To purchase alternative finishes please use the codes below:

Nickel: A56 NKL

Gold: A56 GOLD





# 1300 FREESTANDING UNIT

AVAILABLE IN



Freestanding 1300 vanity unit with doors & Minerva® White with double vanity bowl

W: 1300 D: 550 H: 850-930

Matt White: FC9W + BW12  
 Sand: FC9S + BW12  
 Dark Olive: FC9O + BW12  
 Classic Grey: FC9G + BW12  
 Blue: FC9B + BW12



Freestanding 1300 vanity unit with doors & Minerva® Carrara White with double vanity bowl

W: 1300 D: 550 H: 850-930

Matt White: FC9W + BC12  
 Sand: FC9S + BC12  
 Dark Olive: FC9O + BC12  
 Classic Grey: FC9G + BC12  
 Blue: FC9B + BC12



Freestanding 1300 vanity unit with doors & Minerva® Carrara Black Granite with double vanity bowl

W: 1300 D: 550 H: 850-930

Matt White: FC9W + BB12  
 Sand: FC9S + BB12  
 Dark Olive: FC9O + BB12  
 Classic Grey: FC9G + BB12  
 Blue: FC9B + BB12

AVAILABLE IN



Freestanding 1300 vanity unit with drawers & Minerva® White with double vanity bowl

W: 1300 D: 550 H: 850-930

Matt White: FC10W + BW12  
 Classic Grey: FC10G + BW12



Freestanding 1300 vanity unit with drawers & Minerva® Carrara White with double vanity bowl

W: 1300 D: 550 H: 850-930

Matt White: FC10W + BC12  
 Classic Grey: FC10G + BC12



Freestanding 1300 vanity unit with drawers & Minerva® Carrara Black Granite with double vanity bowl

W: 1300 D: 550 H: 850-930

Matt White: FC10W + BB12  
 Classic Grey: FC10G + BB12

Chrome handles included with the furniture. To purchase alternative finishes please use the codes below:

Nickel: A56 NKL  
 Gold: A56 GOLD

# 1340 CURVED VANITY UNIT

AVAILABLE IN



Freestanding 1340 curved vanity unit with doors & Minerva® White with vanity bowl

W: 1340 D: 550 H: 850-930

Matt White: FC1W + BW13  
 Sand: FC1S + BW13  
 Dark Olive: FC1O + BW13  
 Classic Grey: FC1G + BW13  
 Blue: FC1B + BW13



Freestanding 1340 curved vanity unit with doors & Minerva® Carrara White with vanity bowl

W: 1340 D: 550 H: 850-930

Matt White: FC1W + BC13  
 Sand: FC1S + BC13  
 Dark Olive: FC1O + BC13  
 Classic Grey: FC1G + BC13  
 Blue: FC1B + BC13



Freestanding 1340 curved vanity unit with doors & Minerva® Carrara Black Granite with vanity bowl

W: 1340 D: 550 H: 850-930

Matt White: FC1W + BB13  
 Sand: FC1S + BB13  
 Dark Olive: FC1O + BB13  
 Classic Grey: FC1G + BB13  
 Blue: FC1B + BB13



Freestanding 1340 curved vanity unit with doors and drawers & Minerva® White with vanity bowl

W: 1340 D: 550 H: 850-930

Matt White: FC4W + BW13  
 Sand: FC4S + BW13  
 Dark Olive: FC4O + BW13  
 Classic Grey: FC4G + BW13  
 Blue: FC4B + BW13



Freestanding 1340 curved vanity unit with doors and drawers & Minerva® Carrara White with vanity bowl

W: 1340 D: 550 H: 850-930

Matt White: FC4W + BC13  
 Sand: FC4S + BC13  
 Dark Olive: FC4O + BC13  
 Classic Grey: FC4G + BC13  
 Blue: FC4B + BC13



Freestanding 1340 curved vanity unit with doors and drawers & Minerva® Carrara Black Granite with vanity bowl

W: 1340 D: 550 H: 850-930

Matt White: FC4W + BB13  
 Sand: FC4S + BB13  
 Dark Olive: FC4O + BB13  
 Classic Grey: FC4G + BB13  
 Blue: FC4B + BB13

Chrome handles included with the furniture. To purchase alternative finishes please use the codes below:

Nickel: A56 NKL

Gold: A56 GOLD

# 980 CURVED VANITY UNIT

AVAILABLE IN



Freestanding 980 curved left-handed vanity unit with doors & Minerva® White with left-handed vanity bowl

W: 980 D: 550 H: 850-930

Matt White: FC2W + BW98L  
 Sand: FC2S + BW98L  
 Dark Olive: FC2O + BW98L  
 Classic Grey: FC2G + BW98L  
 Blue: FC2B + BW98L



Freestanding 980 curved left-handed vanity unit with doors & Minerva® Carrara White with left-handed vanity bowl

W: 980 D: 550 H: 850-930

Matt White: FC2W + BC98L  
 Sand: FC2S + BC98L  
 Dark Olive: FC2O + BC98L  
 Classic Grey: FC2G + BC98L  
 Blue: FC2B + BC98L



Freestanding 980 curved left-handed vanity unit with doors & Minerva® Black Granite with left-handed vanity bowl

W: 980 D: 550 H: 850-930

Matt White: FC2W + BB98L  
 Sand: FC2S + BB98L  
 Dark Olive: FC2O + BB98L  
 Classic Grey: FC2G + BB98L  
 Blue: FC2B + BB98L



Freestanding 980 curved right-handed vanity unit with doors & Minerva® White with right-handed vanity bowl

W: 980 D: 550 H: 850-930

Matt White: FC3W + BW98R  
 Sand: FC3S + BW98R  
 Dark Olive: FC3O + BW98R  
 Classic Grey: FC3G + BW98R  
 Blue: FC3B + BC98R



Freestanding 980 curved right-handed vanity unit with doors & Minerva® Carrara White with right-handed vanity bowl

W: 980 D: 550 H: 850-930

Matt White: FC3W + BC98R  
 Sand: FC3S + BC98R  
 Dark Olive: FC3O + BC98R  
 Classic Grey: FC3G + BC98R  
 Blue: FC3B + BC98R



Freestanding 980 curved right-handed vanity unit with doors & Minerva® Black Granite with right-handed vanity bowl

W: 980 D: 550 H: 850-930

Matt White: FC3W + BB98R  
 Sand: FC3S + BB98R  
 Dark Olive: FC3O + BB98R  
 Classic Grey: FC3G + BB98R  
 Blue: FC3B + BB98R

Chrome handles included with the furniture. To purchase alternative finishes please use the codes below:

Nickel: A56 NKL  
 Gold: A56 GOLD

# WALL FURNITURE



**600mm double door wall unit**

W: 600 D: 150 H: 750

Matt White: F6WW  
Sand: F6WS  
Dark Olive: F6WO  
Classic Grey: F6WG  
Blue: F6WB



**300mm single door wall unit**

W: 300 D: 150 H: 750

Matt White: F3WW  
Classic Grey: F3WG  
Blue: F3WB



**600mm mirrored double door wall unit**

W: 600 D: 150 H: 750

Matt White: F6MW  
Sand: F6MS  
Dark Olive: F6MO  
Classic Grey: F6MG



**300mm mirrored single door wall unit**

W: 300 D: 150 H: 750

Matt White: F3MW  
Classic Grey: F3MG



**600mm basin base unit for semi recessed basin**

W: 600 D: 580 H: 1950

Matt White: F6BW  
Sand: F6BS  
Dark Olive: F6BO  
Classic Grey: F6BG  
Blue: F6BB  
Basin: B12



**600mm back-to-wall WC unit with lever and back-to-wall pan**

W: 600 D: 480 H: 850

Matt White: W60W  
Sand: W60S  
Dark Olive: W60O  
Classic Grey: W60G  
Blue: W60B  
Pan: P14



**600mm back-to-wall WC unit with lever and regal back-to-wall pan**

W: 600 D: 480 H: 850

Matt White: W60W  
Sand: W60S  
Dark Olive: W60O  
Classic Grey: W60G  
Blue: W60B  
Pan: P15



**600mm wall-hung WC unit with lever flush cistern WC unit**

W: 600 D: 480 H: 850

Matt White: W60W  
Sand: W60S  
Dark Olive: W60O  
Classic Grey: W60G  
Blue: W60B  
Pan: P10  
Steel Frame: W33A



**600mm double door base unit**

W: 600 D: 300 H: 850

Matt White: F60W  
Classic Grey: F60G



**300mm single door base unit**

W: 300 D: 300 H: 850

Matt White: F30W  
Classic Grey: F30G



**300mm tall two door base unit**

W: 300 D: 300 H: 1910

Matt White: F3TW  
Classic Grey: F3TG



PLEASE CHECK THE PRODUCT TO SEE THE COLOURS AVAILABLE



**Soft-close  
matt white seat**  
(Excluding handles)  
**Matt White:** S45  
**Sand:** S43  
**Dark Olive:** S44  
**Classic Grey:** S46  
**Blue:** S99  
**Handle:** A51 CHR



**Minerva® white  
1200mm worktop**  
**W:** 1200 **D:** 305 **H:** 25  
**White:** BW305



**Minerva® Carrara white  
1200mm worktop**  
**W:** 1200 **D:** 305 **H:** 25  
**Carrara White:** BC305



**Minerva® Carrara black  
1200mm worktop**  
**W:** 1200 **D:** 305 **H:** 25  
**Carrara Black:** BB305



**Framed 600 mirror with  
LED illuminations**  
**W:** 600 **D:** 40 **H:** 750  
**Matt White:** M6MW  
**Sand:** M6MS  
**Dark Olive:** M6MO  
**Classic Grey:** M6MG  
**Blue:** M6MB



**Framed 900 mirror with  
LED illuminations**  
**W:** 900 **D:** 40 **H:** 750  
**Matt White:** M9MW  
**Classic Grey:** M9MG



**Framed 1200 mirror  
with LED illuminations**  
**W:** 1200 **D:** 40 **H:** 750  
**Matt White:** M12MW  
**Sand:** M12MS  
**Dark Olive:** M12MO  
**Classic Grey:** M12MG  
**Blue:** M12MB



**Minerva® Joint Kit, White**  
**Code:** MVCA



**Framed 600 mirror**  
**W:** 600 **D:** 40 **H:** 750  
**Matt White:** M6OW  
**Classic Grey:** M6OG



**Framed 900 mirror**  
**W:** 900 **D:** 40 **H:** 750  
**Matt White:** M9OW  
**Classic Grey:** M9OG



**Framed 1200 mirror**  
**W:** 1200 **D:** 40 **H:** 750  
**Matt White:** M12OW  
**Classic Grey:** M12OG



**Plumbing cover in  
matt grey**  
**W:** 300 **D:** 150 **H:** 750  
**Code:** X02G

# ARUNDEL BATH



**Arundel bath 1700 x 700 with adjustable legs and matching panels**

**W: 700 L: 1700 H: 595**

**Matt White: E28 + E24FW + E25EW**

**Sand: E28 + E24FS + E25ES**

**Dark Olive: E28 + E24FO + E25EO**

**Classic Grey: E28 + E24FG + E25EG**

For bath without panels see page 139

**Arundel bath 1700 x 750 with adjustable legs and matching panels**

**W: 750 L: 1700 H: 595**

**Matt White: E30 + E24FW + E26EW**

**Sand: E30 + E24FS + E26ES**

**Dark Olive: E30 + E24FO + E26EO**

**Classic Grey: E30 + E24FG + E26EG**

For bath without panels see page 139



**Standard bath grips**

Code: R37

For bath panels see page 139

# LONDON BATH



London bath with curved surround including overflow & waste in matt white

W: 850 L: 1800 H: 600

- Matt White: E22W
- Sand: E22S
- Dark Olive: E22O
- Classic Grey: E22G

London back-to-wall bath with curved surround including overflow & waste in matt white

W: 950 D: 1800 H: 600

- Matt White: E23W
- Sand: E23S
- Dark Olive: E23O
- Classic Grey: E23G

London bath is supplied with overflow and fitted waste

# *BATHS*





Beautiful freestanding baths in a range of designs crafted with either TSFR (twin skinned fibre re-inforced acrylic) for superior strength or ClearStone for the epitome of luxury. Choose from soaking tubs, elegant roll top baths with a choice of feet in five styles and three colours or our double-ended or showering baths for flexibility of use.



# BALTHAZAR



## Balthazar double-ended bath

L: 1675 W: 761 H: 711

Stainless steel: N25CS

Black: N25CSB

White: N25CSW

**Weight empty**  
111kg

**Displaced capacity**  
164L

**Material**  
Clearstone

## Finish

Stainless steel. White and Black baths are stainless steel with a powder coated surround.

**Compatible wastes**  
CW3, CW11

## Tap hole options

Not suitable for rim-mounted taps

**Overflow**  
Pre-drilled

## *ADMIRAL DOUBLE-ENDED BATH*



**Admiral double-ended  
1650 / 1800mm bath**  
1650mm L: 1640 W: 705 H: 710  
1800mm L: 1775 W: 890 H: 750  
1650mm code: ET5C  
1800mm code: ET6C

**Weight empty**  
1650mm 48kg  
1800mm 60kg  
**Displaced capacity**  
1650mm 99L  
1800mm 175L  
**Material**  
Acrylic

**Compatible wastes**  
CW3, W4, CW6  
**Tap hole options**  
Not suitable for  
rim-mounted taps  
**Overflow**  
Pre-drilled

## *BRINDLEY DOUBLE-ENDED BATH*



**Brindley double-ended  
bath with surround**

L: 1700 W: 750 H: 620

Code: E5+E12

**Weight empty**  
36kg

**Displaced capacity**  
180L

**Material**  
Acrylic

**Compatible wastes**  
CW2, W3

**Tap hole options**  
Not suitable for  
rim-mounted taps

**Overflow**  
Supplied with  
template, undrilled



## *LONDON ROUND DOUBLE-ENDED BATH*



London round  
double-ended bath  
L: 1800 W: 850 H: 640  
Code: E18

Weight empty  
52g  
Displaced capacity  
200L  
Material  
Acrylic

Compatible wastes  
Pre fitted  
Tap hole options  
Not suitable for rim-mounted taps  
Overflow  
Pre-drilled

# *EMPEROR SLIPPER BATH*



**Emperor slipper bath**  
L: 1530 W: 725 H: 780  
Code: ET13B

**Weight empty**  
38kg  
**Displaced capacity**  
242L  
**Material**  
Acrylic

**Compatible wastes**  
CW2, CW3, W4, CW6, W21  
**Tap hole options**  
Not suitable for rim-mounted taps  
**Overflow**  
Supplied with template, undrilled

## ARUNDEL BATH

### Arundel 700 / 750mm bath

700mm L: 1700 W: 700 H: 580

750mm L: 1700 W: 750 H: 580

700mm code: E28

750mm code: E30

### Weight emptied

700mm 24kg

750mm 25kg

### Displaced capacity

700mm 108L

750mm 125L

### Material

Acrylic with Cleargreen reinforcement

### Compatible wastes

W3

### Compatible bathscreens

C9, C10

### Compatible bath grips

R37

### Tap hole options

Undrilled

### Overflow

Pre-drilled

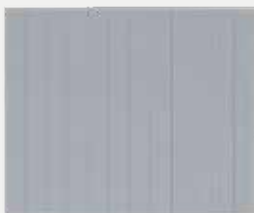

### Arundel 700/750 bath end panels

700mm W: 700 H: 540

750mm W: 750 H: 540

700mm code: E25E\*

750mm code: E26E\*



### Arundel 1700 bath side panel

W: 1700 H: 540

Code: E24F\*

\* To order bath panels in your chosen colour, replace \* with S for Sand, W for White, G for Classic Grey and O for Dark Olive.

## AVANTGARDE BATH



**Avantgarde bath**  
L: 1700 W: 750 H: 630  
Code: T12D

**Weight empty**  
43kg  
**Displaced capacity**  
158L  
**Material**  
TSFR Double Acrylic

**Compatible wastes**  
CW2, CW3, W4, CW6, W21

**Tap hole options**  
0, 1, 2 (supplied with  
template, undrilled)

**Overflow**  
Supplied with template, undrilled

**Feet options**  
See page 148



## *BATEAU DOUBLE-ENDED BATH*



**Bateau double-ended  
1700mm bath**

L: 1640 W: 700 H: 720

Code: T10F

**Weight empty**  
42kg

**Displaced capacity**  
169L

**Material**  
TSFR Double Acrylic

**Compatible wastes**  
CW3, W4, CW6, W21

**Tap hole options**  
Not suitable for rim-mounted taps

**Overflow**  
Pre-drilled

**Feet options**  
See page 148

## *WINDSOR DOUBLE-ENDED BATH*



**Windsor double-ended  
1500 / 1700mm bath**

1500mm L: 1500 W: 750 H: 630

1700mm L: 1700 W: 750 H: 620

1500mm code: E4

1700mm code: E3

**Weight empty**

1500mm 45kg

1700mm 45kg

**Displaced capacity**

1500mm 115L

1700mm 130L

**Material**

TSFR Double Acrylic

**Compatible wastes**

CW2, CW3, W4, W21

**Tap hole options**

0, 1, 2 (supplied with  
template, undrilled)

**Overflow**

Supplied with template, undrilled

**Feet options**

See page 148

## *BUCKINGHAM SLIPPER BATH*



**Buckingham 1500mm  
slipper bath**

L: 1500 W: 740 H: 620

Code: E6

**Weight empty**  
39kg

**Displaced capacity**  
85L

**Material**  
TSFR Double Acrylic

**Compatible wastes**  
CW2, CW3, W4, W21

**Tap hole options**  
0, 1, 2 (supplied with  
template, undrilled)

**Overflow**  
Supplied with template, undrilled

**Feet options**  
See page 148

## *HAREWOOD SLIPPER BATH*



**Harewood 1700mm  
slipper bath**

L: 1690 W: 730 H: 770

Code: E1

**Weight empty**  
48kg

**Displaced capacity**  
125L

**Material**  
TSFR Double Acrylic

**Compatible wastes**  
CW2, CW3, W4, W21

**Tap hole options**  
0, 1, 2 (supplied with  
template, undrilled)

**Overflow**  
Supplied with template, undrilled

**Feet options**  
See page 148



## *BLENHEIM SINGLE-ENDED BATH*



**Blenheim single-  
ended bath**

L: 1690 W: 750 H: 640

Code: E2

**Weight empty**  
45kg

**Displaced capacity**  
115L

**Material**  
TSFR Double Acrylic

**Compatible wastes**  
CW2, CW3, W4, W21

**Tap hole options**  
0, 1, 2 (supplied with  
template, undrilled)

**Overflow**  
Supplied with template, undrilled

**Feet options**  
See page 148

# HAMPTON RIGHT & LEFT-HANDED BATH

Left-handed



Right-handed



## Hampton 1500 / 1700 right and left-handed bath

1500mm L: 1500 W: 750 H: 610  
1700mm L: 1690 W: 750 H: 630

1500 Right: E21

1500 Left: E20

1700 Right: E14

1700 Left: E13

**Compatible wastes**  
W4

**Material**  
Skin with solid core

**Compatible bath grips**  
R37

**Tap hole options**  
0, 1, 2 (supplied with template, undrilled)

**Overflow**  
Supplied with template, undrilled

**Feet options**  
See page 148



Single bathscreen

**Bathscreens**

Single W: 850 H: 1450

Single code: C9



Bathscreen with access panel

**Bathscreens**

Access W: 850 H: 1450

Access code: C10

# *SHOWERING BATH*

For those with a slightly smaller space wanting to make the most out of their bathrooms, why not choose the Hampton showering bath, offering flexibility and versatility to those wanting to bathe and shower. Available in two sizes with both left and right-handed options.

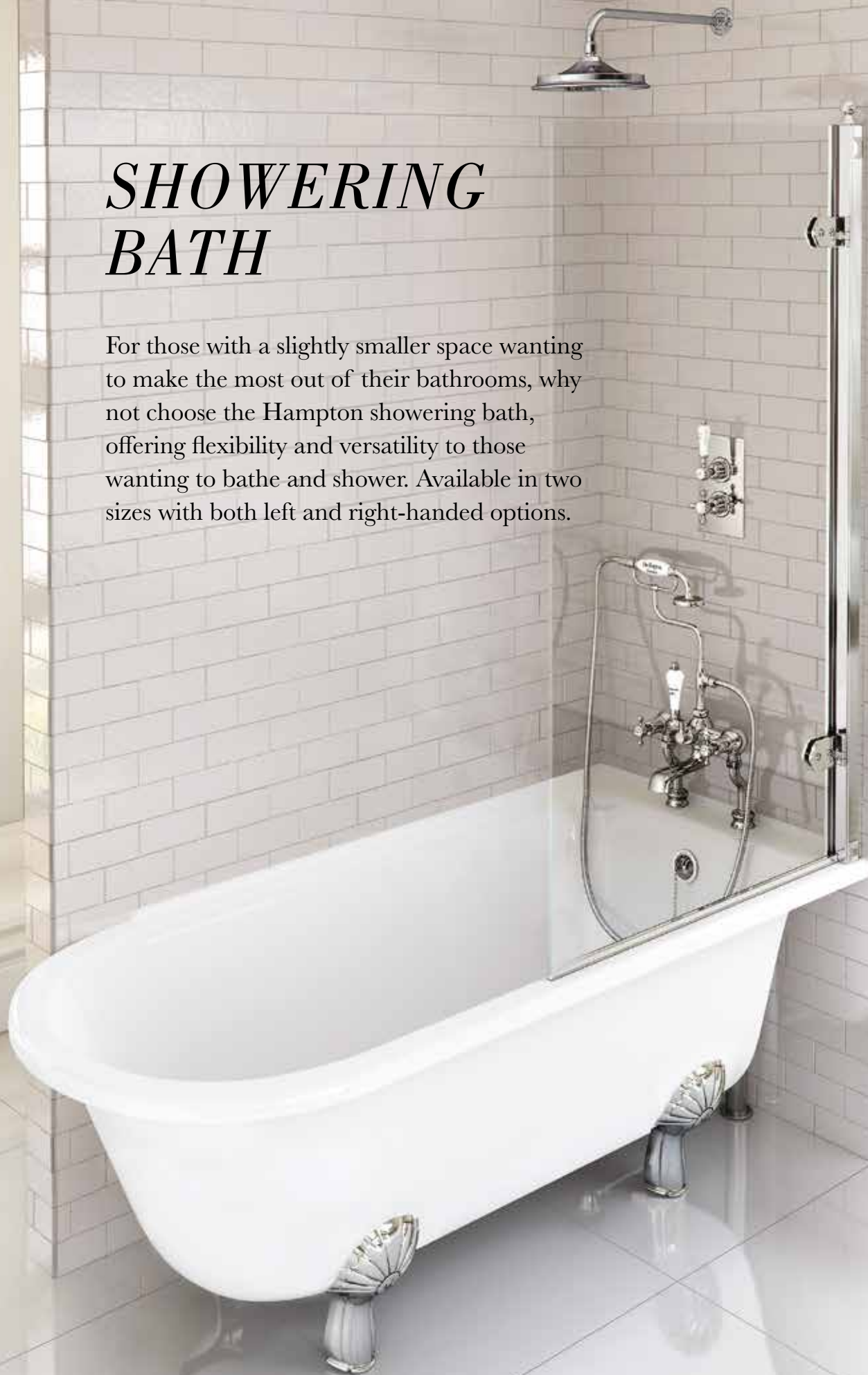

## LUXURY BATH FEET



### Claw feet

Chrome: L1C  
White: L1W  
Black: L1B

### Arc feet

Chrome: L2C  
White: L2W  
Black: L2B

### Classic feet

Chrome: L3C  
White: L3W  
Black: L3B

## STANDARD BATH FEET



### Traditional feet

Chrome: E11 CHR  
White: E11 WHI  
Black: E11 BLA

### Classical feet

Chrome: E10 CHR  
White: E10 WHI  
Black: E10 BLA



## STAND PIPES & SHROUDS



Stand pipes including  
horizontal support bar

W: 280 D: 100 H: 600

Chrome: W7

Nickel: W7 NKL

Gold: W7 GOLD

These are for use with baths where fittings are not rim or wall-mounted (water runs through the pipes). Can be used with deck-mounted taps.



Decorative shrouds

W: 70 D: 70 H: 710

Chrome: W6

Nickel: W6 NKL

Gold: W6 GOLD

These are for use with baths with rim-mounted fittings and can be used with deck-mounted taps.



Now Available in Gold

## *ALBANY FREESTANDING NATURAL STONE BATH*



### **Albany freestanding natural stone bath**

L: 1690 W: 800 H: 570

Code: ARC21

**Weight empty**  
132kg

**Displaced capacity**  
256L

**Material**  
Natural Stone

### **Tap hole options**

Not suitable for rim-mounted taps

### **Overflow**

Integrated overflow  
(excluded the bath waste)

### **Compatible Wastes**

CW1 and CW3

## *MEDICI BATELLO GRANDE BATH*



**Medici Batello  
grande bath**

L: 1690 W: 800 H: 690

Code: N10CS M

**Weight empty**  
66kg

**Displaced capacity**  
151L

**Material**  
ClearStone

**Tap hole options**

Not suitable for rim-mounted taps

**Overflow**

Supplied with template, undrilled

**Compatible Wastes**

CW2, CW2NCS, W4, CW3,  
CW11, W21

# BRASSWARE



Burlington brassware can be customised with a choice of 4 tap heads; Claremont, Birkenhead, Anglesey and Kensington. In addition, Burlington is the first British Traditional designed range that enables water savings despite varying water pressures. We supply every tap with two Neoperl devices: A flow straightener, which is for use with low water pressures and an aerator, which is for use with high water pressures. Now available in Gold and Nickel finishes in selected products.



*GOLD AND NICKEL NOW AVAILABLE IN CLAREMONT SEE PAGE 154/155*

*CLAREMONT*

*BIRKENHEAD*

*ANGLESEY*

*KENSINGTON*



add CL to start of code



add BI to start of code



add AN to start of code



add KE to start of code

*NORMAL SPOUT*



The underside of a bath spout of a normal, traditional bath tap.

*BURLINGTON SPOUT*



The underside of a Burlington bath tap with a Neoperl aerator.

## *BURLINGTON TAP OPTIONS*

Chrome tap heads are available with Black and Medici ceramic indices as opposed to White.



Claremont



Anglesey



Birkenhead



Kensington



Kensington

Our Kensington tap is now available in Walnut. See page 162 for more details.





**Normal tap**

Water flow in a normal traditional tap.



**Low pressure**

Low pressure water flow with a Burlington tap using a flow straightener.



**High pressure**

High pressure water flow with a Burlington tap using an aerator.

Our taps are designed to deliver the following maximum flows of water, regardless of the incoming water pressure:

**Basin taps:** 13L per minute  
**Bath tap:** 14L per minute  
**Bath shower mixer:** 22L per minute



**Swivelling spouts**

All our bath fillers and bath shower mixer spouts swivel - so you don't have the spout in your way when you shower.



**Angled mixers**

All our bath fillers and bath shower mixers are available in an 'angled' version.

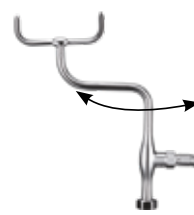

**S adjuster**

The S adjuster allows the telephone handset to be positioned over the bath. The bath shower mixer can be installed with or without the 'S adjuster'.

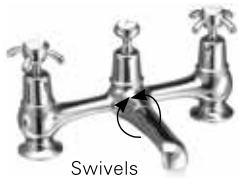

**Bridge mixers**

Our bridge basin mixer has a swivelling spout and allows you to have mixed hot & cold water, whilst using a two taphole configuration.



- Straight down
- 90° left or right
- Straight up
- Normal basin mixer
- Off



Traditional screw-down



Quarter turn

**Valve options**

All Burlington taps are available with traditional screwdown valves or with quarter-turn valves. The taps work with both low and high pressure.

# QUARTER TURN GOLD TAPS

· NEW ·

## One tap hole



Basin mixer with high central indice with click-clack waste

Code: CL6-QT GOLD  
Regent code: CLR6-QT GOLD



Basin mixer with high central indice with pop up waste

Code: CL4-QT GOLD  
Regent code: CLR4-QT GOLD

## Two tap hole



Basin tap 3"

Code: CL1-QT GOLD  
Regent code: CLR1-QT GOLD



Basin tap 5"

Code: CL2-QT GOLD  
Regent code: CLR2-QT GOLD

## Three tap hole



Three tap hole mixer with pop up waste

Code: CL12-QT GOLD  
Regent code: CLR12-QT GOLD

## Deck-mounted



Bath shower mixer deck-mounted with 'S' adjuster

Code: CL15-QT GOLD  
Regent code: CLR15-QT GOLD

## Wall-mounted



Bath shower mixer wall-mounted with 'S' adjuster

Code: CL17-QT GOLD  
Regent code: CLR17-QT GOLD

### REGENT OPTIONS

Our regent base which can be used on all one, two and three tap hole taps (excluding Chelsea and Stafford) offers an extra height of 30mm than the standard tap base and adds a further 30mm distance away from the wall when wall-mounted.



Standard



Regent



# QUARTER TURN NICKEL TAPS



## One tap hole



Basin mixer with high central indice with click-clack waste

Code: CL6-QT NKL  
Regent code: CLR6-QT NKL



Basin mixer with high central indice with pop up waste

Code: CL4-QT NKL  
Regent code: CLR4-QT NKL

## Two tap hole



Basin tap 3"

Code: CL1-QT NKL  
Regent code: CLR1-QT NKL



Basin tap 5"

Code: CL2-QT NKL  
Regent code: CLR2-QT NKL

## Three tap hole



Three tap hole mixer with pop up waste

Code: CL12-QT NKL  
Regent code: CLR12-QT NKL

## Deck-mounted



Bath shower mixer deck-mounted with 'S' adjuster

Code: CL15-QT NKL  
Regent code: CLR15-QT NKL

## Wall-mounted



Bath shower mixer wall-mounted with 'S' adjuster

Code: CL17-QT NKL  
Regent code: CLR17-QT NKL

### GOLD & NICKEL TAPS

Please note these taps are only available in the quarter turn option.

Only available with the Claremont tap head.

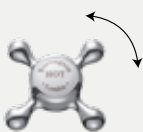

Quarter turn



# TRADITIONAL SCREW DOWN BASIN TAPS

## One tap hole



Basin mixer with high central indice with click-clack waste

White: CL6  
White regent: CLR6  
Black: CL6 BLA  
Black regent: CLR6 BLA  
Medici: CL6 MED  
Medici regent: CLR6 MED



Basin mixer with high central indice with pop up waste

White: CL4  
White regent: CLR4  
Black: CL4 BLA  
Black regent: CLR4 BLA  
Medici: CL4 MED  
Medici regent: CLR4 MED



Basin mixer with high central indice with plug and chain waste

White: CL5  
White regent: CLR5  
Black: CL5 BLA  
Black regent: CLR5 BLA  
Medici: CL5 MED  
Medici regent: CLR5 MED



Bidet mixer with high central indice with plug and chain waste

White: CL13  
White regent: CLR13  
Black: CL13 BLA  
Black regent: CLR13 BLA  
Medici: CL13 MED  
Medici regent: CLR13 MED

## Two tap hole



Basin tap 3"

White: CL1  
White regent: CLR1  
Black: CL1 BLA  
Black regent: CLR1 BLA  
Medici: CL1 MED  
Medici regent: CLR1 MED



Basin tap 5"

White: CL2  
White regent: CLR2  
Black: CL2 BLA  
Black regent: CLR2 BLA  
Medici: CL2 MED  
Medici regent: CLR2 MED



Two tap hole bridge mixer with swivelling spout with plug and chain waste

White: CL10  
White regent: CLR10  
Black: CL10 BLA  
Black regent: CLR10 BLA  
Medici: CL10 MED  
Medici regent: CLR10 MED



Two tap hole arch mixer with curved spout (200mm centres)

White: CL27  
White Regent: CLR27  
Black: CL27 BLA  
Black regent: CLR27 BLA  
Medici: CL27 MED  
Medici regent: CLR27 MED

## Three tap hole



Two tap hole arch mixer with curved spout (230mm centre)

White: CL28  
White regent: CLR28  
Black: CL28 BLA  
Black regent: CLR28 BLA  
Medici: CL28 MED  
Medici regent: CLR28 MED



Three tap hole mixer with pop up waste

White: CL12  
White regent: CLR12  
Black: CL12 BLA  
Black regent: CLR12 BLA  
Medici: CL12 MED  
Medici regent: CLR12 MED

### REGENT OPTIONS

Our regent base which can be used on all one, two and three tap hole taps (excluding Chelsea and Stafford) offers an extra height of 30mm than the standard tap base and adds a further 30mm distance away from the wall when wall-mounted.



Standard



Regent



# TRADITIONAL SCREW DOWN BATH TAPS

## Deck-mounted



### Bath shower mixer deck-mounted with 'S' adjuster

White: CL15  
 White regent: CLR15  
 Black: CL15 BLA  
 Black regent: CLR15 BLA  
 Medici: CL15 MED  
 Medici regent: CLR15 MED

### Angled bath shower mixer deck-mounted

White: CL19  
 White regent: CLR19  
 Black: CL19 BLA  
 Black regent: CLR19 BLA  
 Medici: CL19 MED  
 Medici regent: CLR19 MED

### Bath filler deck-mounted

White: CL23  
 White regent: CLR23  
 Black: CL23 BLA  
 Black regent: CLR23 BLA  
 Medici: CL23 MED  
 Medici regent: CLR23 MED

### Bath tap deck-mounted

White: CL3  
 White regent: CLR3  
 Black: CL3 BLA  
 Black regent: CLR3 BLA  
 Medici: CL3 MED  
 Medici regent: CLR3 MED

## Wall-mounted



### Bath shower mixer wall-mounted with 'S' adjuster

White: CL17  
 White regent: CLR17  
 Black: CL17 BLA  
 Black regent: CLR17 BLA  
 Medici: CL17 MED  
 Medici regent: CLR17 MED

### Angled bath shower mixer wall-mounted

White: CL21  
 White regent: CLR21  
 Black: CL21 BLA  
 Black regent: CLR21 BLA  
 Medici: CL21 MED  
 Medici regent: CLR21 MED

### Bath filler wall-mounted

White: CL24  
 White regent: CLR24  
 Black: CL24 BLA  
 Black regent: CLR24 BLA  
 Medici: CL24 MED  
 Medici regent: CLR24 MED

### Ordering Your Taps

When ordering your taps add the correct code to the start of the tap code.

Claremont add **CL**  
 Anglesey add **AN**  
 Birkenhead add **BI**  
 Kensington add **KE**

### QUARTER TURN OPTIONS

To order your tap with quarter-turn valves add QT to the end of your brassware code. (Kensington taps are only available as quarter-turn valves).



Traditional screw-down

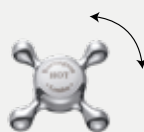

Quarter turn

### COLOUR OPTIONS

Matching your taps to your bathroom colour scheme has become even easier.

We have 3 additional accent colours as an alternative to White indices; Black, Medici and luxurious Walnut (Only available with Kensington handles - see pages 158/159 for more details).

To order add the accent colour code to the end of the standard tap code.

Black add **BLA**  
 Medici add **MED**  
 Walnut add **WAL**



White



Black



Medici



Walnut

# WALNUT BASIN TAPS

## One tap hole



Basin mixer with high central indice with click-clack waste

Code: KE6-QT WAL  
Regent code: KER6-QT WAL



Basin mixer with high central indice with pop up waste

Code: KE4-QT WAL  
Regent code: KER4-QT WAL



Basin mixer with high central indice with plug and chain waste

Code: KE5-QT WAL  
Regent code: KER5-QT WAL



Bidet mixer with high central indice with plug and chain waste

Code: KE13-QT WAL  
Regent code: KER13-QT WAL

## Two tap hole



Basin tap 3"

Code: KE1-QT WAL  
Regent code: KER1-QT WAL



Basin tap 5"

Code: KE2-QT WAL  
Regent code: KER2-QT WAL



Two tap hole bridge mixer with swivelling spout with plug and chain waste

Code: KE10-QT WAL  
Regent code: KER10-QT WAL



Two tap hole arch mixer with curved spout (200mm centres)

Code: KE27-QT WAL  
Regent code: KER27-QT WAL

## Three tap hole



Two tap hole arch mixer with curved spout (230mm centre)

Code: KE28-QT WAL  
Regent code: KER28-QT WAL



Three tap hole mixer with pop up waste

Code: KE12-QT WAL  
Regent code: KER12-QT WAL



# WALNUT BATH TAPS

## Deck-mounted



**Bath shower mixer deck-mounted with 'S' adjuster**

Code: KE15-QT WAL  
Regent code: KER15-QT WAL

**Bath filler deck-mounted**

Code: KE23-QT WAL  
Regent code: KER23-QT WAL

**Bath tap deck-mounted**

Code: KE3-QT WAL  
Regent code: KER3-QT WAL

**Angled bath shower mixer deck-mounted**

Code: KE19-QT WAL  
Regent code: KER19-QT WAL

## Wall-mounted



**Bath shower mixer wall-mounted with 'S' adjuster**

Code: KE17-QT WAL  
Regent code: KER17-QT WAL

**Angled bath shower mixer wall-mounted**

Code: KE21-QT WAL  
Regent code: KER21-QT WAL

**Bath filler wall-mounted**

Code: KE24-QT WAL  
Regent code: KER24-QT WAL



### WALNUT OPTION

Our Walnut taps give the perfect finishing touches and work beautifully with our other feature options such as WC seats and accessories.

Please note our Walnut taps are only available as Kensington with quarter-turn valves.

## THERMOSTATIC

Match your basin, bath and shower with the convenience and safety of thermostatic controls for your bathroom.



**3 tap hole basin mixer with pop up waste**

White: CL29  
Black: CL29 BLA  
Medici: CL29 MED



**Bath shower mixer deck-mounted with 'S' adjuster**

White: T2DB  
Black: T2DB BLA  
Walnut: T2DB WAL  
Medici: T2DB MED



**Thermostatic two outlet twin control bath shower mixer valve**

**White Ceramic**

BT2DS+V16  
BT2DS+V17  
BT2DS+V60  
BT2WS+V16  
BT2WS+V17  
BT2WS+V60

**Black Ceramic**

BT2DS BLA+V16  
BT2DS BLA+V17  
BT2DS BLA+V60  
BT2WS BLA+V16  
BT2WS BLA+V17  
BT2WS BLA+V60

### THERMOSTATIC SAFETY

We use Vernet wax capsules throughout our thermostatic brassware and showering valves, meaning temperature when in use will not vary by more than + 1 degrees.

## STAFFORD

Please note the stafford collection cannot be paired with any other tap head options.



**Stafford bath pillar taps**

Code: STA13



**Stafford long nose basin pillar taps**

Code: STA12



**Stafford mono basin mixer with pop up waste**

Code: STA11



**Stafford bath shower mixer deck-mounted**

Code: STA14

Please note that the Stafford does not include an 'S' adjuster.



# CHELSEA



**Chelsea straight basin mixer with pop up waste**

White: CH20  
 Black: CH20 BLA  
 Walnut: CH20 WAL  
 Medici: CH20 MED



**Chelsea curved basin mixer without waste**

White: CH21  
 Black: CH21 BLA  
 Walnut: CH21 WAL  
 Medici: CH21 MED



**Chelsea curved basin mixer with pop up waste**

White: CH22  
 Black: CH22 BLA  
 Walnut: CH22 WAL  
 Medici: CH22 MED



**Chelsea curved bidet mixer with pop up waste**

White: CH23  
 Black: CH23 BLA  
 Walnut: CH23 WAL  
 Medici: CH23 MED



**Chelsea straight basin mixer without waste**

White: CH19  
 Black: CH19 BLA  
 Walnut: CH19 WAL  
 Medici: CH19 MED

## UNIQUE AESTHETICS

The Chelsea brassware range comes with its own unique, bespoke tap heads and are not available as Claremont, Anglesey or Birkenhead. The lever can be changed from white to black, walnut or Medici. Chelsea's range also comes with the choice of curved or straight spout.



**Chelsea curved tall basin mixer without waste**

White: CHE2  
 Black: CHE2 BLA  
 Walnut: CHE2 WAL  
 Medici: CHE2 MED



**Chelsea straight tall basin mixer without waste**

White: CHE1  
 Black: CHE1 BLA  
 Walnut: CHE1 WAL  
 Medici: CHE1 MED



**FOR BATHS**



**Shallow p trap**

Chrome: CW3  
Nickel: CW3 NKL  
Gold: CW3 GOLD



**Bath overflow plug and chain**

Chrome: W3  
Nickel: W3 NKL  
Gold: W3 GOLD



**Black/Medici bath overflow plug and chain**

Black: W3 BLA  
Medici: W3 MED



**P trap connection pipe**

Chrome: W21  
Nickel: W21 NKL  
Gold: W21 GOLD



**Overflow filler for single/double-ended baths**

Single code: W15  
Double code: W2



**Black/Medici overflow filler for single/double-ended baths**

Black Single: W15 BLA  
Black Double: W2 BLA  
Medici Single: W15 MED  
Medici Double: W2 MED



**Click-clack bath waste (slotted) with chrome cover**

Code: CW1  
For use with internal overflow bath.



**Click-clack bath waste (unslotted) with chrome cover**

Code: CW2  
For use without internal overflow bath.



**Special bath waste without a pre-drilled overflow hole**

Code: CW11

With unslotted click-clack waste



**Exposed bath overflow, click-clack waste**

Code: CW6



**Exposed bath overflow, plug and chain**

Chrome: W4  
Nickel: W4 NKL  
Gold: W4 GOLD



**Black/Medici exposed bath overflow, plug and chain**

Black: W4 BLA  
Medici: W4 MED



*FOR BASINS*

Selected items now available in Gold and Nickel



**Flat bottom bottle trap**  
Code: W13



**Traditional bottle trap**  
Chrome: W14  
Nickel: W14 NKL  
Gold: W14 GOLD



**Flip top basin waste, slotted, chrome**  
Chrome: W18  
Nickel: W18 NKL  
Gold: W18 GOLD



**Tap hole stopper, chrome**  
Code: A49 CHR



**Click-clack (push button) basin waste**  
Chrome: W11  
Nickel: W11 NKL  
Gold: W11 GOLD



**Basin plug and chain, slotted**  
Chrome: W1  
Nickel: W1 NKL  
Gold: W1 GOLD



**Burlington basin tap shut off valves (hot/cold)**  
W: 348 D: 64 H: 112  
Code: W28



**Black/Medici Burlington basin tap shut off valves (hot/cold)**  
W: 348 D: 64 H: 112  
Black: W28 BLA  
Medici: W28 MED

*FOR BIDETS*

*FOR WCS*

*FOR SHOWERS*



**Bidet trap**  
Code: W27



**Cistern tank on/off valve**  
Chrome: W25  
Nickel: W25 NKL



**Black/Medici cistern tank on/off valve**  
Black: W25 BLA  
Medici: W25 MED



**Angled connector for telephone handset, chrome**  
Code: V62



# ARCADE BRASSWARE



Nickel dual lever basin mixer without pop up waste

W: 200 D: 184 H: 215

Crosshead: ACL14N  
 Nickel Lever: ABBL14N  
 White Lever: AWL14N  
 Black lever: ABL14N



Nickel single lever basin mixer without pop up waste

W: 65 D: 174 H: 174

Crosshead: ACL12N  
 Nickel Lever: ABBL12N  
 White Lever: AWL12N  
 Black lever: ABL12N



Nickel mini single lever basin mixer without pop up waste

W: 59 D: 137 H: 107

Crosshead: ACL35N  
 Nickel Lever: ABBL35N  
 White Lever: AWL35N  
 Black lever: ABL35N



Chrome dual lever basin mixer without pop up waste

W: 200 D: 184 H: 215

Crosshead: ACL14C  
 Chrome Lever: ABBL14C  
 White Lever: AWL14C  
 Black lever: ABL14C



Chrome single lever basin mixer without pop up waste

W: 65 D: 174 H: 174

Crosshead: ACL12C  
 Chrome Lever: ABBL12C  
 White Lever: AWL12C  
 Black lever: ABL12C



Chrome mini single lever basin mixer without pop up waste

W: 59 D: 137 H: 107

Crosshead: ACL35C  
 Chrome Lever: ABBL35C  
 White Lever: AWL35C  
 Black lever: ABL35C

## LEVER OPTIONS

Every piece of Arcade brassware, whether you choose from the elegant lustre of nickel or the high shine of chrome, is available with either crosshead tap heads or levers in corresponding nickel or chrome, serene White ceramic or intense Black ceramic, each with a timeless quality.



Crosshead



Nickel Lever



White Ceramic Lever



Matt Black Ceramic Lever



## ARCADE BRASSWARE



Nickel three hole basin mixer deck-mounted without pop up waste

W: 260 D: 219 H: 158

Crosshead: ACL15N  
Nickel Lever: ABBL15N  
White Lever: AWL15N  
Black lever: ABL15N



Nickel three hole basin mixer wall-mounted without pop up waste

W: 260 D: 259 H: 158

Crosshead: ACL16N  
Nickel Lever: ABBL16N  
White Lever: AWL16N  
Black lever: ABL16N



Nickel basin pillar taps

W: 239 D: 161 H: 150

Crosshead: ACL17N  
Nickel Lever: ABBL17N  
White Lever: AWL17N  
Black lever: ABL17N



Chrome three hole basin mixer deck-mounted without pop up waste

W: 260 D: 219 H: 158

Crosshead: ACL15C  
Chrome Lever: ABBL15C  
White Lever: AWL15C  
Black lever: ABL15C



Chrome three hole basin mixer wall-mounted without pop up waste

W: 260 D: 259 H: 158

Crosshead: ACL16C  
Chrome Lever: ABBL16C  
White Lever: AWL16C  
Black lever: ABL16C



Chrome basin pillar taps

W: 239 D: 161 H: 150

Crosshead: ACL17C  
Chrome Lever: ABBL17C  
White Lever: AWL17C  
Black lever: ABL17C

### FLOW RATES

All Arcade taps are supplied with aerator's and flow straightener's.  
Flow rates are between 0.2 & 5 bar.



**Flow straightener**  
This is for use with low water pressure.



**Aerator**  
This is for use with high pressure.



**Nickel cloakroom basin pillar taps**

W: 239 D: 132 H: 140

Crosshead: ACL36N  
 Nickel Lever: ABBL36N  
 White Lever: AWL36N  
 Black lever: ABL36N



**Nickel single lever bidet mixer with pop up waste**

W: 65 D: 192 H: 174

Crosshead: ACL13N  
 Nickel Lever: ABBL13N  
 White Lever: AWL13N  
 Black lever: ABL13N



**Nickel bath shower mixer wall-mounted**

W: 290 D: 280 H: 327

Crosshead: ACL19N  
 Nickel Lever: ABBL19N  
 White Lever: AWL19N  
 Black lever: ABL19N



**Chrome cloakroom basin pillar taps**

W: 239 D: 132 H: 140

Crosshead: ACL36C  
 Chrome Lever: ABBL36C  
 White Lever: AWL36C  
 Black lever: ABL36C



**Chrome single lever bidet mixer with pop up waste**

W: 65 D: 192 H: 174

Crosshead: ACL13C  
 Chrome Lever: ABBL13C  
 White Lever: AWL13C  
 Black lever: ABL13C



**Chrome bath shower mixer wall-mounted**

W: 290 D: 280 H: 327

Crosshead: ACL19C  
 Chrome Lever: ABBL19C  
 White Lever: AWL19C  
 Black lever: ABL19C

**LEVER OPTIONS**

Every piece of Arcade brassware, whether you choose from the elegant lustre of nickel or the high shine of chrome, is available with either crosshead tap heads or levers in corresponding nickel or chrome, serene White ceramic or intense Black ceramic, each with a timeless quality.



Crosshead



Nickel Lever



White Ceramic Lever



Matt Black Ceramic Lever



## ARCADE BRASSWARE



Nickel bath shower mixer deck-mounted

W: 290 D: 370 H: 400

Crosshead: ACL18N  
 Nickel Lever: ABBL18N  
 White Lever: AWL18N  
 Black lever: ABL18N



Chrome bath shower mixer deck-mounted

W: 290 D: 370 H: 400

Crosshead: ACL18C  
 Chrome Lever: ABBL18C  
 White Lever: AWL18C  
 Black lever: ABL18C



Nickel single lever bath shower filler, floor-mounted inc. floor mounting kit

W: 120 D: 373 H: 825-907

Nickel Lever: ABBL20N  
 White Lever: AWL20N  
 Black lever: ABL20N



Chrome single lever bath shower filler, floor-mounted inc. floor mounting kit

W: 120 D: 373 H: 825-907

Chrome Lever: ABBL20C  
 White Lever: AWL20C  
 Black lever: ABL20C

### LEVER OPTIONS

Every piece of Arcade brassware, whether you choose from the elegant lustre of nickel or the high shine of chrome, is available with either crosshead tap heads or levers in corresponding nickel or chrome, serene White ceramic or intense Black ceramic, each with a timeless quality.



Crosshead



Brass Lever



White Ceramic Lever



Matt Black Ceramic Lever

# *SHOWERING*

The Burlington range of showers provides extensive options for you to create a showering solution for your own bespoke setting. Whether you prefer showering over a bath or within an enclosure, our range of thermostatic valves offer safe and controllable showering for the entire family. Partner either with a wide range of enclosure styles from hinged or sliding doors to quadrant enclosures, each with corresponding trays with superior strength, the best grade in non-slip technology and an anti-bacterial coating as standard. Now available in Gold and Nickel finish in selected products.







# TRENT

## Concealed thermostatic showers

For Trent in a Gold finish see page 179 for a Nickel finish see page 180

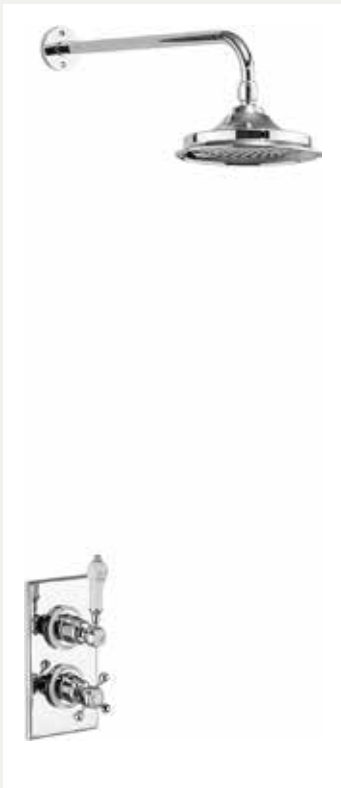

Thermostatic single function brass valve with independent temperature control

Traditional brass faceplate and Claremont handle with ceramic lever

390mm adjustable fixed shower arm

6", 9", 12" AirBurst shower head

### White Ceramic

TF1S+V16  
TF1S+V17  
TF1S+V60

### Black Ceramic

TF1S BLA+V16  
TF1S BLA+V17  
TF1S BLA+V60

### Medici Ceramic

TF1S MED+V16  
TF1S MED+V17  
TF1S MED+V60



Thermostatic single function brass valve with independent temperature control

Traditional brass faceplate and Claremont handle with ceramic lever

Slide rail including the elbow, hose and handset with ceramic handle

6", 9", 12" AirBurst shower head

### White Ceramic

TF1H

### Black Ceramic

TF1H BLA

### Medici Ceramic

TF1H MED

## OPTIONAL EXTRAS

When ordering the optional bath Spout V32 you will also need the extended riser V22, if you wish to retain the handset function you will need to order V24 and V27 products.



**Soap basket**  
Code: V23



**Cradle**  
Code: V24



**Slide rail**  
Code: V33  
Black code: V33 BLA



**Ceramic handset, hose & diverter**  
Code: V27



**Spout fitting**  
Code: V32

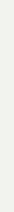

**Extended vertical riser rail**  
Code: V22



Thermostatic dual function brass valve with independent flow diverter and temperature control

Traditional brass faceplate and Claremont handle with ceramic lever

Wall outlet and 1500mm shower hose

Adjustable wall bracket and handset with ceramic handle

390mm adjustable shower arm

6", 9", 12" AirBurst shower head

**White Ceramic**

- TF2S+V16
- TF2S+V17
- TF2S+V60

**Black Ceramic**

- TF2S BLA+V16
- TF2S BLA+V17
- TF2S BLA+V60

**Medici Ceramic**

- TF2S MED+V16
- TF2S MED+V17
- TF2S MED+V60



Thermostatic dual function brass valve with two independent on/ off controls and central temperature control

Traditional brass faceplate and Claremont handle with ceramic lever

Wall outlet and 1500mm shower hose

Adjustable wall bracket and handset with ceramic handle

390mm adjustable shower arm

6", 9", 12" AirBurst shower head

**White Ceramic**

- TF3S+V16
- TF3S+V17
- TF3S+V60

**Black Ceramic**

- TF3S BLA+V16
- TF3S BLA+V17
- TF3S BLA+V60

**Medici Ceramic**

- TF3S MED+V16
- TF3S MED+V17
- TF3S MED+V60

**THERMOSTATIC SHOWERING**



Within the valve there is an automatic adjuster which maintains temperature by adjusting the flow of each supply. This is useful in guarding against the possibility of scalding. If for instance, someone flushes a WC whilst you are showering, the flow of hot water will immediately be closed down to compensate for the reduced cold water flow.

**SHOWER VALVE HANDLE OPTIONS**



**Anglesey single valve**

White code: V2  
Black code: V2 BLA

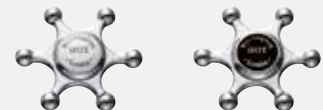

**Birkenhead single valve**

White code: V3  
Black code: V3 BLA

# SEVERN

## Concealed thermostatic showers

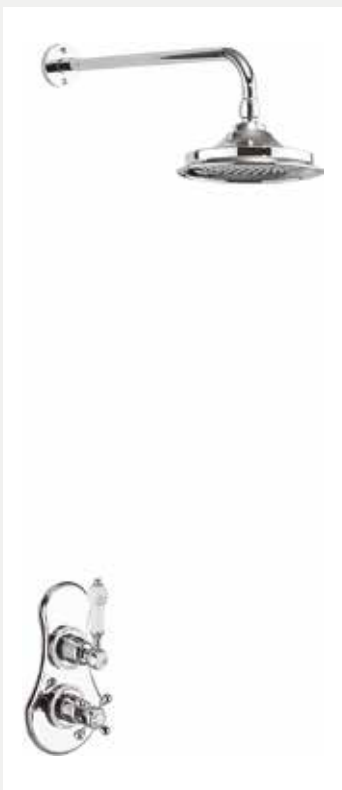

Thermostatic single function brass valve with independent temperature control

Traditional brass faceplate and Claremont handle with ceramic lever

390mm adjustable fixed shower arm

6", 9", 12" AirBurst shower head

White Ceramic

VF1S+V16

VF1S+V17

VF1S+V60



Thermostatic dual function brass valve with two independent on / off controls and central temperature control

Traditional brass faceplate and Claremont handle with ceramic lever

Wall outlet and 1500mm shower hose

Adjustable wall bracket and handset with ceramic handle

390mm adjustable shower arm

6", 9", 12" AirBurst shower head

White Ceramic

VF3S+V16

VF3S+V17

VF3S+V60

### OPTIONAL EXTRAS

When ordering the optional bath spout V32 you will also need the extended riser V22, if you wish to retain the handset function you will need to order V24 and V27 products.



Soap basket

Code: V23



Cradle

Code: V24



Slide rail

Code: V33

Black code: V33 BLA



Ceramic handset, hose & diverter

Code: V27



Spout fitting

Code: V32

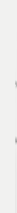

Extended vertical riser rail

Code: V22

# AVON

## Exposed thermostatic showers

For Avon in a Gold finish see page 179 for a Nickel finish see page 181



Thermostatic single function brass valve with independent temperature control  
 Traditional brass body and Claremont handle with ceramic lever  
 390mm adjustable fixed shower arm  
 6", 9", 12" AirBurst shower head

**White Ceramic**

- AF1S+V16
- AF1S+V17
- AF1S+V60



Thermostatic dual function brass valve with two independent on / off controls and central temperature control  
 Traditional brass body and Claremont handle & ceramic lever  
 Adjustable wall bracket, 1500mm shower hose and handset with ceramic handle  
 18mm diameter vertical brass shower riser  
 355mm adjustable swivel shower arm  
 6", 9", 12" AirBurst shower head

**White Ceramic**

- BAF3S+V16
- BAF3S+V17
- BAF3S+V60
- BAF3S.EXT+V16
- BAF3S.EXT+V17
- BAF3S.EXT+V60

**Black Ceramic**

- BAF3S BLA+V16
- BAF3S BLA+V17
- BAF3S BLA+V60
- BAF3S.EXT BLA+V16
- BAF3S.EXT BLA+V17
- BAF3S.EXT BLA+V60

**Medici Ceramic**

- BAF3S MED+V16
- BAF3S MED+V17
- BAF3S MED+V60

### SHOWER HEAD HEIGHT

The standard riser pipe (V21) has a length of 856mm.

To increase the height of your shower head use the extended riser (V22) which has a length of 1814mm increasing the height by 958mm.

To order the extended riser simply add .EXT to the product code. For example BSF1S changes to BSF1S.EXT

Please see the [burlingtonbathrooms.com](http://burlingtonbathrooms.com) for details.

### SHOWER VALVE HANDLE OPTIONS



**Anglesey single valve**

White code: V2  
 Black code: V2 BLA

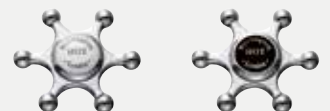

**Birkenhead single valve**

White code: V3  
 Black code: V3 BLA



# TAY

## Bath shower thermostatic showers



Thermostatic two outlet twin control bath shower mixer valve with independent flow diverter and temperature controls

Traditional brass body and Claremont handles, with ceramic indices

Brass bath spout with swivel function

Available deck or wall-mounted

S connector and bracket, 1500mm shower hose and handset with ceramic handle

White Ceramic

Deck: T2DB  
Wall: T2WB

Black Ceramic

Deck: T2DB BLA  
Wall: T2WB BLA



Thermostatic two outlet twin control bath shower mixer valve with independent flow diverter and temperature controls

Traditional brass body and Claremont handles, with ceramic indices

Brass bath spout with swivel function

Available deck or wall-mounted

18mm diameter vertical brass shower riser

355mm adjustable swivel shower arm

6", 9", 12" AirBurst shower head

White Ceramic

Deck: BT2DS+V16  
Deck: BT2DS+V17  
Deck: BT2DS+V60  
Wall: BT2WS+V16  
Wall: BT2WS+V17  
Wall: BT2WS+V60

Black Ceramic

Deck: BT2DS BLA+V16  
Deck: BT2DS BLA+V17  
Deck: BT2DS BLA+V60  
Wall: BT2WS BLA+V16  
Wall: BT2WS BLA+V17  
Wall: BT2WS BLA+V60

Medici Ceramic

Deck: BT2DS MED+V16  
Deck: BT2DS MED+V17  
Deck: BT2DS MED+V60  
Wall: BT2WS MED+V16  
Wall: BT2WS MED+V17  
Wall: BT2WS MED+V60

### OPTIONAL EXTRAS

When ordering the optional bath Spout V32 you will also need the extended riser V22, if you wish to retain the handset function you will need to order V24 and V27 products.



Soap basket  
Code: V23



Cradle  
Code: V24



Slide rail  
Code: V33  
Black code: V33 BLA



Ceramic handset, hose & diverter  
Code: V27



Spout fitting  
Code: V32

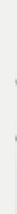

Extended vertical riser rail  
Code: V22

# EDEN

## Exposed thermostatic showers

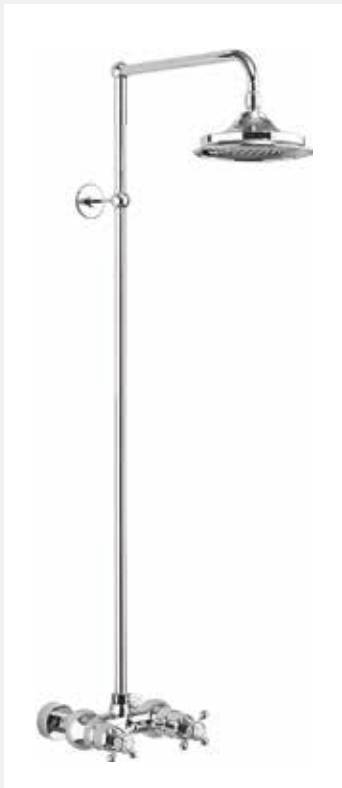

Thermostatic single outlet twin control valve with independent on / off flow and temperature control  
 Traditional brass body and Claremont handle with ceramic indices  
 18mm diameter vertical brass shower riser  
 355mm adjustable swivel shower arm  
 6", 9", 12" AirBurst shower head

**White Ceramic**

- BEF1S+V16
- BEF1S+V17
- BEF1S+V60
- BEF1S.EXT+V16
- BEF1S.EXT+V17
- BEF1S.EXT+V60

**Black Ceramic**

- BEF1S BLA+V16
- BEF1S BLA+V17
- BEF1S BLA+V60
- BEF1S.EXT BLA+V16
- BEF1S.EXT BLA+V17
- BEF1S.EXT BLA+V60

**Medici Ceramic**

- BEF1S MED+V16
- BEF1S MED+V17
- BEF1S MED+V60



Thermostatic two outlet twin control valve with independent flow diverter and temperature control  
 Traditional brass body and Claremont handle with ceramic indices  
 Adjustable wall bracket, 1500mm shower hose and handset with ceramic handle  
 18mm diameter vertical brass shower riser  
 355mm adjustable swivel shower arm  
 6", 9", 12" AirBurst shower head

**White Ceramic**

- BEF2S+V16
- BEF2S+V17
- BEF2S+V60
- BEF2S.EXT+V16
- BEF2S.EXT+V17
- BEF2S.EXT+V60

**Black Ceramic**

- BEF2S BLA+V16
- BEF2S BLA+V17
- BEF2S BLA+V60
- BEF2S.EXT BLA+V16
- BEF2S.EXT BLA+V17
- BEF2S.EXT BLA+V60

**Medici Ceramic**

- BEF2S MED+V16
- BEF2S MED+V17
- BEF2S MED+V60

**ONE WAY WATER**



Our non-return valves ensure the flow of water in only one direction, ensuring heating efficiency, preventing siphonage of contaminated water and keeping your shower cartridge in excellent condition for longer.

**AIRBURST SHOWER HEADS**



By combining air and water, the pressure inside the shower head is increased. The power of a traditional shower head with up to 33% water saved.

**SHOWER VALVE HANDLE OPTIONS**



**Anglesey single valve**

White code: V2  
 Black code: V2 BLA



**Birkenhead single valve**

White code: V3  
 Black code: V3 BLA

# STOUR

## Exposed thermostatic showers



Thermostatic single function brass valve with independent temperature control

Traditional brass body and Claremont handle with ceramic lever

6", 9", 12" AirBurst shower head

---

White Ceramic

BF1S+V16  
BF1S+V17  
BF1S+V60



Thermostatic single function brass valve with independent temperature control

Traditional brass body and Claremont handle with ceramic lever

28mm diameter vertical brass shower riser

450mm adjustable fixed shower arm

Soap basket

6", 9", 12" AirBurst shower head

---

White Ceramic

BF2S+V16  
BF2S+V17  
BF2S+V60



Thermostatic dual function brass valve with two independent on / off controls and central temperature control

Traditional brass body, Claremont handle with ceramic lever

Fixed cradle, 1500mm shower hose and handset with ceramic handle

28mm diameter vertical brass shower riser

450mm adjustable fixed shower arm

Soap basket

6", 9", 12" AirBurst shower head

---

White Ceramic

BF3S+V16  
BF3S+V17  
BF3S+V60

## TRENT - GOLD

Concealed thermostatic showers

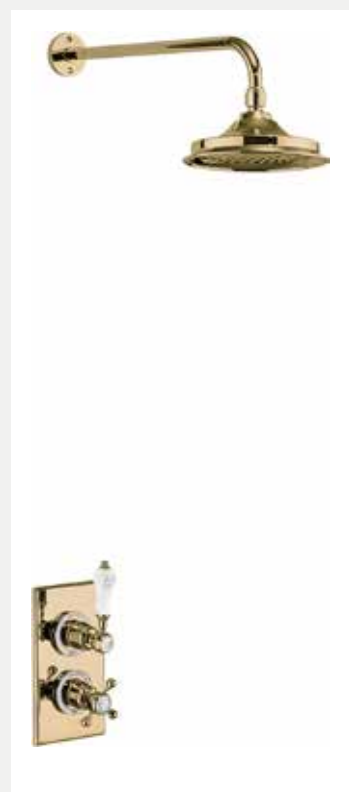

Thermostatic single function brass valve with independent temperature control

Traditional brass faceplate and Claremont handle with ceramic lever

390mm adjustable fixed shower arm

9" AirBurst shower head

---

White Ceramic  
TF1S GOLD+V17

## AVON - GOLD

Exposed thermostatic showers



Thermostatic dual function brass valve with independent flow diverter and temperature control

Traditional brass faceplate and Claremont handle with ceramic lever

Wall outlet and 1500mm shower hose

Adjustable wall bracket and handset with ceramic handle

390mm adjustable shower arm

9" AirBurst shower head

---

White Ceramic  
TF2S GOLD+V17



Thermostatic dual function brass valve with two independent on / off controls and central temperature control

Traditional brass body and Claremont handle with ceramic lever

Adjustable wall bracket, 1500mm shower hose and handset with ceramic handle

18mm diameter vertical brass shower riser

355mm adjustable swivel shower arm

9" AirBurst shower head

---

White Ceramic  
BAF3S GOLD+V17

Gold shower head available as V17 only.

• **NEW** •

· NEW ·

# TRENT - NICKEL

Concealed thermostatic showers

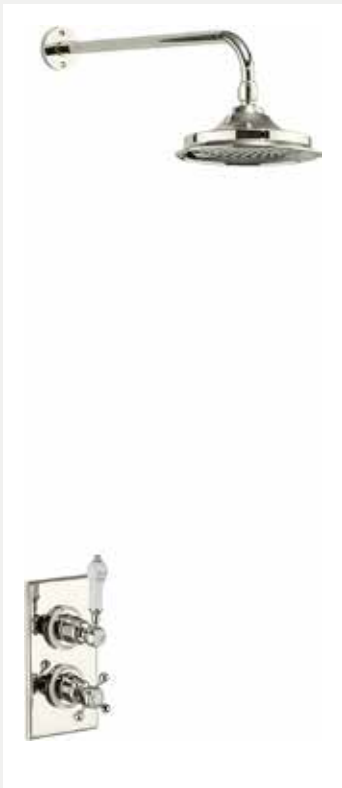

Thermostatic single function brass valve with independent temperature control

Traditional brass faceplate and Claremont handle with ceramic lever

390mm adjustable fixed shower arm

9" or 12" AirBurst shower head

White Ceramic

TF1S NKL+V17 NKL

TF1S NKL+V60 NKL



Thermostatic dual function brass valve with independent flow diverter and temperature control

Traditional brass faceplate and Claremont handle with ceramic lever

Wall outlet and 1500mm shower hose

Adjustable wall bracket and handset with ceramic handle

390mm adjustable shower arm

9" or 12" AirBurst shower head

White Ceramic

TF2S NKL+V17 NKL

TF2S NKL+V60 NKL

## OPTIONAL EXTRAS

When ordering the optional bath Spout V32 you will also need the extended riser V22, if you wish to retain the handset function you will need to order V24 and V27 products.



Soap basket

Code: V23 NKL



Slide rail

Code: V33 NKL



Ceramic handset, hose & diverter

Code: V27 NKL



Spout fitting

Code: V32 NKL



Extended vertical riser rail

Code: V22 NKL

Nickel shower heads available as V17 and V60 only.



## AVON - NICKEL

### Exposed thermostatic showers



Thermostatic dual function  
brass valve with two  
independent on / off controls  
and central temperature control

Traditional brass body and  
Claremont handle with  
ceramic lever

Adjustable wall bracket,  
1500mm shower hose and  
handset with ceramic handle

18mm diameter vertical brass  
shower riser

355mm adjustable swivel  
shower arm

9" or 12" AirBurst  
shower head

---

White Ceramic

BAF3S NKL+V17 NKL

BAF3S NKL+V60 NKL



## HINGED DOORS

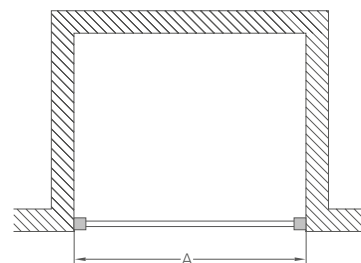

Size*	Adjustment min-max	Enclosure code	Tray code
760 x 760	720 - 760	BU1 (C19)	Z1159
800 x 800	760 - 800	BU2 (C20)	Z1160
900 x 760	860 - 900	BU3 (C21)	Z1163
900 x 800	860 - 900	BU3 (C21)	Z1164
900 x 900	860 - 900	BU3 (C21)	Z1161
900 x 1200	860 - 900	BU3 (C21)	Z1176

\*This indicates depth of matching tray size available for use in a recessed installation. All enclosures are 1950mm high and adjustable up to 20mm from each wall.

All shower posts are constructed from aluminium and can be installed with or without chrome ball header. Safety glass is 8mm thick and 3M™ easy clean coating.

Shower tray prices exclude waste  
Code: Z1205

# HINGED DOORS & SIDE PANELS

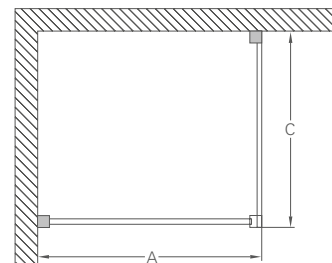

Size*	Adjustment min-max	Enclosure code	Tray code
760 x 760	730 - 750	BU11 (C19 + C12)	Z1159
760 x 900	730 - 750 870 - 890	BU12 (C19 + C14)	Z1163
800 x 800	770 - 790	BU13 (C20 + C13)	Z1160
800 x 900	770 - 790 870 - 890	BU14 (C20 + C14)	Z1164
900 x 760	730 - 750 870 - 890	BU15 (C21 + C12)	Z1163
900 x 800	770 - 790 870 - 890	BU16 (C21 + C13)	Z1164
900 x 900	870 - 900	BU17 (C21 + C14)	Z1161

\*This indicates depth of matching tray size available for use in a recessed installation. All enclosures are 1950mm high and adjustable up to 20mm from each wall.

All shower posts are constructed from aluminium and can be installed with or without chrome ball header. Safety glass is 8mm thick and 3M™ easy clean coating.

Shower tray prices exclude waste  
Code: Z1205

## HINGED DOORS & SIDE PANELS

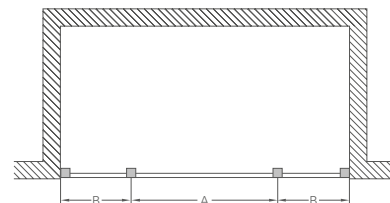

Size*	Adjustment min-max	Enclosure code	Tray code
1000 x 700	960 - 1000	BU4 (C20 + C15)	Z1165
1000 x 760	960 - 1000	BU4 (C20 + C15)	Z1166
1000 x 800	960 - 1000	BU4 (C20 + C15)	Z1167
1000 x 900	960 - 1000	BU4 (C20 + C15)	Z1168
1000 x 1000	960 - 1000	BU4 (C20 + C15)	Z1162
1100 x 700	1060 - 1100	BU5 (C20 + C16)	Z1169
1100 x 760	1060 - 1100	BU5 (C20 + C16)	Z1170
1100 x 800	1060 - 1100	BU5 (C20 + C16)	Z1171
1100 x 900	1060 - 1100	BU5 (C20 + C16)	Z1172
1200 x 700	1160 - 1200	BU6 (C20 + C17)	Z1173
1200x 760	1160 - 1200	BU6 (C20 + C17)	Z1174
1200 x 800	1160 - 1200	BU6 (C20 + C17)	Z1175
1200 x 900	1160 - 1200	BU6 (C20 + C17)	Z1176
1400 x 800	1360 - 1400	BU7 (C20 + C16 + C16)	Z1177
1400 x 900	1360 - 1400	BU7 (C20 + C16 + C16)	Z1178
1500 x 700	1460 - 1500	BU8 (C21 + C16 + C16)	Z1179
1500 x 760	1460 - 1500	BU8 (C21 + C16 + C16)	Z1180
1500 x 800	1460 - 1500	BU8 (C21 + C16 + C16)	Z1181
1600 x 700	1560 - 1600	BU9 (C20 + C17 + C17)	Z1182
1700 x 700	1560 - 1700	BU10 (C21 + C17 + C17)	Z1183
1700 x 760	1660 - 1700	BU10 (C21 + C17 + C17)	Z1184
1700 x 800	1660 - 1700	BU10 (C21 + C17 + C17)	Z1185

\*This indicates depth of matching tray size available for use in a recessed installation. All enclosures are 1950mm high and adjustable up to 20mm from each wall.

All shower posts are constructed from aluminium and can be installed with or without chrome ball header. Safety glass is 8mm thick and 3M™ easy clean coating.

Shower tray prices exclude waste  
Code: Z1205

# HINGED DOORS & SIDE PANELS

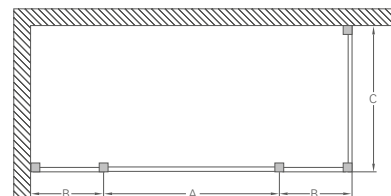

Size*	Adjustment min-max	Enclosure code	Tray code
1000 x 760	730 - 750 970 - 990	BU19 (C20 + C15 + C12)	Z1166
1000 x 800	770 - 790 970 - 990	BU20 (C20 + C15 + C13)	Z1167
1000 x 900	870 - 890 970 - 990	BU21 (C20 + C15 + C14)	Z1168
1100 x 760	730 - 750 1070 - 1090	BU23 (C20 + C16 + C12)	Z1170
1100 x 800	770 - 790 1070 - 1090	BU24 (C20 + C16 + C13)	Z1171
1100 x 900	870 - 890 1070 - 1090	BU25 (C20 + C16 + C14)	Z1172
1200 x 760	730 - 750 1170 - 1190	BU27 (C20 + C17 + C12)	Z1174
1200 x 800	770 - 790 1170 - 1190	BU28 (C20 + C17 + C13)	Z1175
1200 x 900	870 - 890 1170 - 1190	BU29 (C20 + C17 + C14)	Z1176
1400 x 800	770 - 790 1370 - 1390	BU30 (C20 + C16 + C16 + C13)	Z1177
1400x 900	870 - 890 1370 - 1390	BU31 (C20 + C16 + C16 + C14)	Z1178
1500 x 760	730 - 750 1470 - 1490	BU33 (C21 + C16 + C16 + C12)	Z1180
1500 x 800	770 - 790 1470 - 1490	BU34 (C21 + C16 + C16 + C13)	Z1181
1700 x 760	730 - 750 1670 - 1690	BU37 (C21 + C17+ C17 + C12)	Z1184
1700 x 800	770 - 790 1670 - 1690	BU38 (C21 + C17+ C17 + C13)	Z1185

\*This indicates depth of matching tray size available for use in a recessed installation. All enclosures are 1950mm high and adjustable up to 20mm from each wall.

All shower posts are constructed from aluminium and can be installed with or without chrome ball header. Safety glass is 8mm thick and 3M™ easy clean coating.

Shower tray prices exclude waste  
Code: Z1205



## QUADRANTS

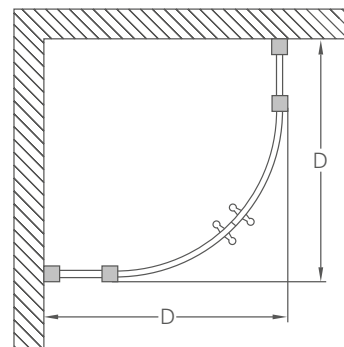

Size*	Adjustment min-max	Enclosure code	Tray code
800 x 800	770 - 790	BU39 (C22)	Z1192
900 x 900	870 - 890	BU40 (C23)	Z1193

\*This indicates depth of matching tray size available for use in a recessed installation. All enclosures are 1950mm high and adjustable up to 20mm from each wall.

All shower posts are constructed from aluminium and can be installed with or without chrome ball header. Safety glass is 8mm thick and 3M™ easy clean coating.

Shower tray prices exclude waste  
Code: Z1205

# OFFSET QUADRANTS

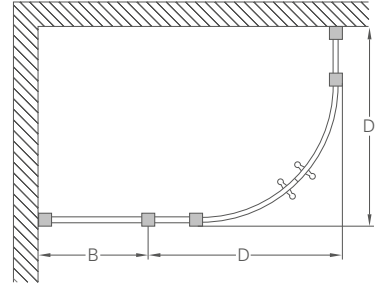

Right hand

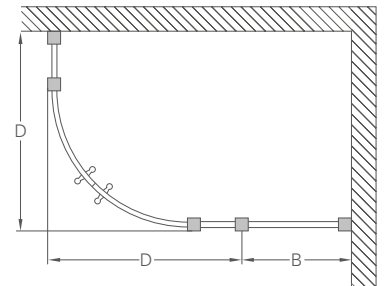

Left hand

Size*	Adjustment min-max	Enclosure code	Tray code
800 x 1000 Left hand	730 - 790 970 - 990	BU41 (C22 + C15)	Z1199
800 x 1000 Right hand	770 - 790 970 - 990	BU41 (C22 + C15)	Z1200
800 x 1200 Left hand	770 - 790 1170 - 1190	BU91 (C22 + C17)	Z1201
800 x 1200 Right hand	770 - 790 1170 - 1190	BU91 (C22 + C17)	Z1202
900 x 1200 Left hand	870 - 890 1170 - 1190	BU42 (C23 + C16)	Z1203
900 x 1200 Right hand	870 - 890 1170 - 1190	BU42 (C23 + C16)	Z1204

\*This indicates depth of matching tray size available for use in a recessed installation. All enclosures are 1950mm high and adjustable up to 20mm from each wall.

All shower posts are constructed from aluminium and can be installed with or without chrome ball header. Safety glass is 8mm thick and 3M™ easy clean coating.

Shower tray prices exclude waste  
Code: Z1205

## SLIDING DOORS

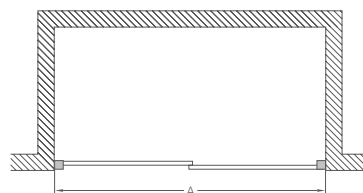

Sliding door

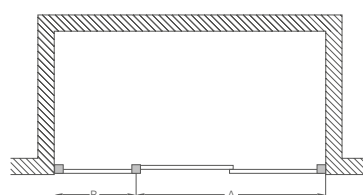

Sliding door with in line panel

### SOFT-CLOSE SLIDING DOOR

Size*	Adjustment min-max	Enclosure code	Tray code
1100 x 700	1070 - 1090	BU68 (C6S)	Z1169
1100 x 760	1070 - 1090	BU68 (C6S)	Z1170
1100 x 800	1070 - 1090	BU68 (C6S)	Z1171
1100 x 900	1070 - 1090	BU68 (C6S)	Z1172
1200 x 700	1170 - 1190	BU69 (C7S)	Z1173
1200 x 760	1170 - 1190	BU69 (C7S)	Z1174
1200 x 800	1170 - 1190	BU69 (C7S)	Z1175
1200 x 900	1170 - 1190	BU69 (C7S)	Z1176
1400 x 800	1370 - 1390	BU70 (C8S)	Z1177
1400 x 800	1370 - 1390	BU70 (C8S)	Z1178

\*This indicates depth of matching tray size available for use in a recessed installation. All enclosures are 1950mm high and adjustable up to 20mm from each wall.

All shower posts are constructed from aluminium and can be installed with or without chrome ball header. Safety glass is 8mm thick and 3M™ easy clean coating.

Shower tray prices exclude waste  
Code: Z1205

### SOFT-CLOSE SLIDING DOOR WITH IN LINE PANEL

Size*	Adjustment min-max	Enclosure code	Tray code
1000 x 760	730 - 750 970 - 990	BU19 (C20 + C15 + C12)	Z1166
1000 x 800	770 - 790 970 - 990	BU20 (C20 + C15 + C13)	Z1167
1000 x 900	870 - 890 970 - 990	BU21 (C20 + C15 + C14)	Z1168
1100 x 760	730 - 750 1070 - 1090	BU23 (C20 + C16 + C12)	Z1170
1100 x 800	770 - 790 1070 - 1090	BU24 (C20 + C16 + C13)	Z1171
1100 x 900	870 - 890 1070 - 1090	BU25 (C20 + C16 + C14)	Z1172
1100 x 900	730 - 750 1170 - 1190	BU27 (C20 + C17 + C12)	Z1174

## SLIDING DOORS WITH SIDE PANELS

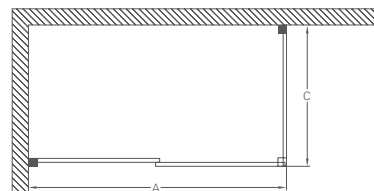

Sliding door with side panel

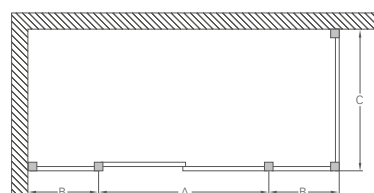

Sliding door with in line and side panel

### SOFT-CLOSE SLIDING DOOR WITH SIDE PANEL

Size*	Adjustment min-max	Enclosure code	Tray code
1100 x 760	730 - 750 1070 - 1090	BU75 (C6S + C12)	Z1170
1100 x 800	770 - 790 1070 - 1090	BU76 (C6S + C13)	Z1171
1100 x 900	870 - 890 1070 - 1090	BU77 (C6S + C14)	Z1172
1200 x 760	730 - 750 1070 - 1090	BU79 (C7S + C12)	Z1174
1200 x 800	770 - 790 1070 - 1090	BU80 (C7S + C13)	Z1175
1200 x 900	870 - 890 1070 - 1090	BU81 (C7S + C14)	Z1176
1400 x 800	770 - 790 1370 - 1390	BU82 (C8S + C13)	Z1177
1400 x 900	870 - 890 1370 - 1390	BU83 (C8S + C14)	Z1178

\*This indicates depth of matching tray size available for use in a recessed installation. All enclosures are 1950mm high and adjustable up to 20mm from each wall.

All shower posts are constructed from aluminium and can be installed with or without chrome ball header. Safety glass is 8mm thick and 3M™ easy clean coating.

Shower tray prices exclude waste  
Code: Z1205

### SOFT-CLOSE SLIDING DOOR WITH IN LINE & SIDE PANEL

Size*	Adjustment min-max	Enclosure code	Tray code
1500 x 760	730 - 750 1470 - 1490	BU85 (C7S + C16 + C12)	Z1180
1500 x 800	770 - 790 1470 - 1490	BU86 (C7S + C16 + C13)	Z1181
1700 x 760	730 - 750 1670 - 1690	BU89 (C8S + C16 + C12)	Z1184
1700 x 800	770 - 790 1670 - 1690	BU90 (C8S + C16 + C13)	Z1185

# *ACCESSORIES, RADIATORS & LIGHTS*

Burlington bathrooms offer a range of accessories, radiators, mirrors and lights for the perfect finishing touch to your traditionally styled bathroom.







## BURLINGTON ACCESSORIES

Continue luxury styling throughout your classic themed bathroom with a range of accessories combining chrome, nickel or NEW gold plated solid brass or Walnut with White, Black or Medici ceramic so your bathroom not only looks beautifully traditional but is effortlessly functional too.



**Soap dish**

W: 160 L: 150 H: 60  
Code: A1 CHR MED



**Tumbler holder**

W: 80 L: 120 H: 110  
Code: A2 CHR MED



**WC brush holder**

W: 100 L: 150 H: 430  
Code: A8 CHR MED

### *MEDICI ACCESSORIES*

Our Medici accessories are perfect for pairing with Medici ceramics or to complement Burlington Jet. Available in selected models in the accessory collection.



**Soap dish**

W: 160 L: 150 H: 60  
Code: A1 CHR BLA



**Tumbler holder**

W: 80 L: 120 H: 110  
Code: A2 CHR BLA



**WC brush holder**

W: 100 L: 150 H: 430  
Code: A8 CHR BLA

### *BLACK ACCESSORIES*

Introducing our Black Accessories. They are the perfect finishing touch and work beautifully with our other black options such as WC seats, brassware and shower valves.

· NEW ·



**Soap dish**

W: 160 L: 150 H: 60  
Chrome: A1 CHR  
Nickel: A1 NKL  
Gold: A1 GOLD



**Tumbler holder**

W: 80 L: 120 H: 110  
Chrome: A2 CHR  
Nickel: A2 NKL  
Gold: A2 GOLD



**WC brush holder**

W: 100 L: 150 H: 430  
Chrome: A8 CHR  
Nickel: A8 NKL  
Gold: A8 GOLD

### *GOLD ACCESSORIES*

Our most popular Burlington accessories are now available in a gold finish as a beautiful alternative to chrome and nickel. Pair these with our new gold brassware for a truly traditional bathroom.



**Accessory back plate**

W: 30 L: 60 H: 60  
**Walnut:** G13 WAL  
**Chrome:** G13



**Single soap dispenser**

W: 80 L: 140 H: 210  
**Chrome:** A19 CHR  
**Nickel:** A19 NKL  
**Gold:** A19 GOLD



**Double soap dispenser**

W: 190 L: 130 H: 210  
**Code:** A20 CHR



**Surface mounted soap dispenser**

W: 70 L: 70 H: 110  
**Code:** A48 CHR



**WC roll holder**

W: 80 L: 180 H: 120  
**Chrome:** A5 CHR  
**Nickel:** A5 NKL  
**Gold:** A5 GOLD



**WC roll holder**

W: 100 L: 180 H: 100  
**Code:** A16 CHR  
 Without cover



**Spire WC roll holder**

W: 170 L: 60 H: 250  
**Code:** A45 CHR



**Spare WC roll holder**

W: 120 L: 60 H: 80  
**Code:** A6 CHR



**Towel ring**

W: 170 L: 60 H: 200  
**Chrome:** A3 CHR  
**Nickel:** A3 NKL  
**Gold:** A3 GOLD



**Robe hook**

W: 60 L: 60 H: 60  
**Chrome:** A14 CHR  
**Nickel:** A14 NKL  
**Gold:** A14 GOLD



**Double robe hook**

W: 60 L: 110 H: 120  
**Chrome:** A4 CHR  
**Nickel:** A4 NKL  
**Gold:** A4 GOLD



**Triple robe hook**

W: 100 L: 70 H: 90  
**Code:** A47 CHR



**Medium ornate bracket**

W: 230 L: 20 H: 160

Code: T32 CHR



**Glass shelf with railing**

W: 530 L: 160 H: 60

Code: A18 CHR



**Brass extendible bath rack**

W: 590-900 L: 210 H: 90

Code: A27 CHR



**Soap basket**

W: 140 L: 120 H: 60

Code: A13 CHR



**Sponge basket**

W: 220 L: 180 H: 60

Code: A15 CHR



**Wire basket**

W: 330 L: 160 H: 90

Code: A23 CHR



**Corner basket**

W: 220 L: 220 H: 60

Code: A21 CHR



**Corner basket**

W: 280 L: 280 H: 90

Code: A22 CHR



**Towel rack**

W: 660 L: 320 H: 140

Code: A46 CHR



**Burlington bath basket**

W: 290 L: 240 H: 110

Code: A50 CHR



**Angled rail with soap basket left hand**

W: 435 L: 124 H: 201

Code: A52 CHR



**Angled rail with soap basket right hand**

W: 435 L: 124 H: 201

Code: A53 CHR



**Straight rail**  
W: 460 L: 90 H: 60  
Code: A54 CHR



**Angled rail**  
W: 396 L: 89 H: 190  
Code: A55 CHR



**Single towel rail**  
W: 550 L: 60 H: 60  
Code: A7 CHR



**Double towel rail**  
W: 660 L: 150 H: 170  
Code: A17 CHR



## BURLINGTON RADIATORS



**Trafalgar**

W: 642 L: 235 H: 950  
 Chrome: R1 CHR  
 Nickel: R1 NKL



**Trafalgar Black**

W: 642 L: 235 H: 950  
 Code: R1 CHR BLA



**Bloomsbury**

W: 497 L: 235 H: 950  
 Chrome: R2 CHR  
 Nickel: R2 NKL



**Bloomsbury Black**

W: 497 L: 235 H: 950  
 Code: R2 CHR BLA



**Chaplin**

W: 542 L: 126 H: 1142  
 Code: R12 CHR

Burlington radiators offer a broad range of various styles.

There are options here to complement your traditional bathroom beautifully. All Burlington radiators except the Strand (R11 CHR) are designed to work with the extra fitting of an electric summer heating kit, allowing warm towels all year round.



**Vincent**  
 W: 642 L: 235 H: 950  
 Code: R5 CHR



**Berkeley**  
 W: 642 L: 235 H: 950  
 Code: R4 CHR



**Clever**  
 W: 642 L: 235 H: 950  
 Chrome: R3 CHR  
 Nickel: R3 NKL



**Strand**  
 W: 642 L: 390 H: 404  
 Code: R11 CHR



400W summer electric heating kit for Trafalgar  
 Code: R10 CHR  
 250W summer electric heating kit for Bloomsbury  
 Code: R9 CHR  
 150W summer electric heating kit for Chaplin, Cleaver, Berkeley & Vincent  
 Code: R8 CHR



**Straight Radiator valves**  
 W: 85 L: 99 H: 235  
 Chrome: R7 CHR  
 Nickel: R7 NKL  
 Medici: R7 CHR MED



**Angled Radiator valves**  
 W: 85 L: 65 H: 235  
 Chrome: R6 CHR  
 Nickel: R6 NKL



**Angled Black/Medici Radiator valves**  
 W: 85 L: 65 H: 235  
 Black: R6 CHR BLA  
 Medici: R6 CHR MED

Type	$\Delta T=50^{\circ}c$ Watts	$\Delta T=55^{\circ}c$ Watts	$\Delta T=60^{\circ}c$ Watts	BTU's
Trafalgar	558	623	688	2346
Bloomsbury	387	430	473	1613
Vincent	206	227	246	839
Berkeley	238	263	289	985
Cleaver	266	294	323	1101
Strand	153	174	196	669
Chaplin	320	372	408	1392



\*For full details on guarantees please visit [burlingtonbathrooms.com/guarantee](http://burlingtonbathrooms.com/guarantee). 197

# BURLINGTON MIRRORS



**Distressed aluminium frame**

W: 550 D: 40 H: 750  
Code: T37 ALU



**Black aluminium frame**

W: 550 D: 40 H: 750  
Code: T47 BLA



**White aluminium frame**

W: 550 D: 40 H: 750  
Code: T42 WHI



**Arched**

W: 500 D: 30 H: 700  
Code: A9



**Rectangular**

W: 500 D: 30 H: 700  
Code: A11



**Curved**

W: 700 D: 30 H: 700  
Code: A38



**Cosmetic wall mirror chrome**

W: 180 D: 285 H: 340-440  
Code: A57 CHR



**Rectangular swivel mirror with curved corners**

W: 590 D: 66 H: 620  
Chrome: A40 CHR  
Nickel: A40 NKL

# BURLINGTON LIGHTS



Burlington round light with chrome base and cup frosted glass shade  
Code: EL/BL11



Burlington round light with chrome base and vase clear glass shade  
Code: EL/BL14



Burlington round light with chrome base and tube frosted glass shade  
Code: EL/BL13



Burlington round light with chrome base and fine pleated shade in white  
Code: EL/BL12



Burlington round light with chrome base and chiffon silver shade  
Code: EL/BL15



Burlington ornate light with chrome base and cup frosted glass shade  
Code: EL/BL21



Burlington ornate light with chrome base and vase clear glass shade  
Code: EL/BL24



Burlington ornate light with chrome base and tube frosted glass shade  
Code: EL/BL23



Burlington ornate light with chrome base and fine pleated shade in white  
Code: EL/BL22



Burlington ornate light with chrome base and chiffon silver shade  
Code: EL/BL25



Edwardian single round LED light - chrome  
Code: T50



Edwardian single elliptical LED light - chrome  
Code: T52

## ARCADE LIGHTS



Oval nickel base with  
cup frosted glass shade  
Code: EL/AL11



Oval nickel base with  
vase clear glass shade  
Code: EL/AL14



Oval nickel base with  
tube frosted glass shade  
Code: EL/AL13



Oval nickel base with fine  
pleated shade in white  
Code: EL/AL12



Oval nickel base with  
chiffon silver shade  
Code: EL/AL15



*Burlington*<sup>®</sup>



Part of the  
**Bathroom Brands Group**  
+44 (0)1322 473 222  
info@bathroombrands.com  
burlingtonbathrooms.com

Lake View House  
Rennie Drive,  
Dartford  
Kent, DA1 5FU







Part of the  
**Bathroom Brands Group**  
+44 (0)1322 473 222  
info@bathroombrands.com  
burlingtonbathrooms.com

Lake View House  
Rennie Drive,  
Dartford  
Kent, DA1 5FU

